



This is a digital copy of a book that was preserved for generations on library shelves before it was carefully scanned by Google as part of a project to make the world's books discoverable online.

It has survived long enough for the copyright to expire and the book to enter the public domain. A public domain book is one that was never subject to copyright or whose legal copyright term has expired. Whether a book is in the public domain may vary country to country. Public domain books are our gateways to the past, representing a wealth of history, culture and knowledge that's often difficult to discover.

Marks, notations and other marginalia present in the original volume will appear in this file - a reminder of this book's long journey from the publisher to a library and finally to you.

Usage guidelines

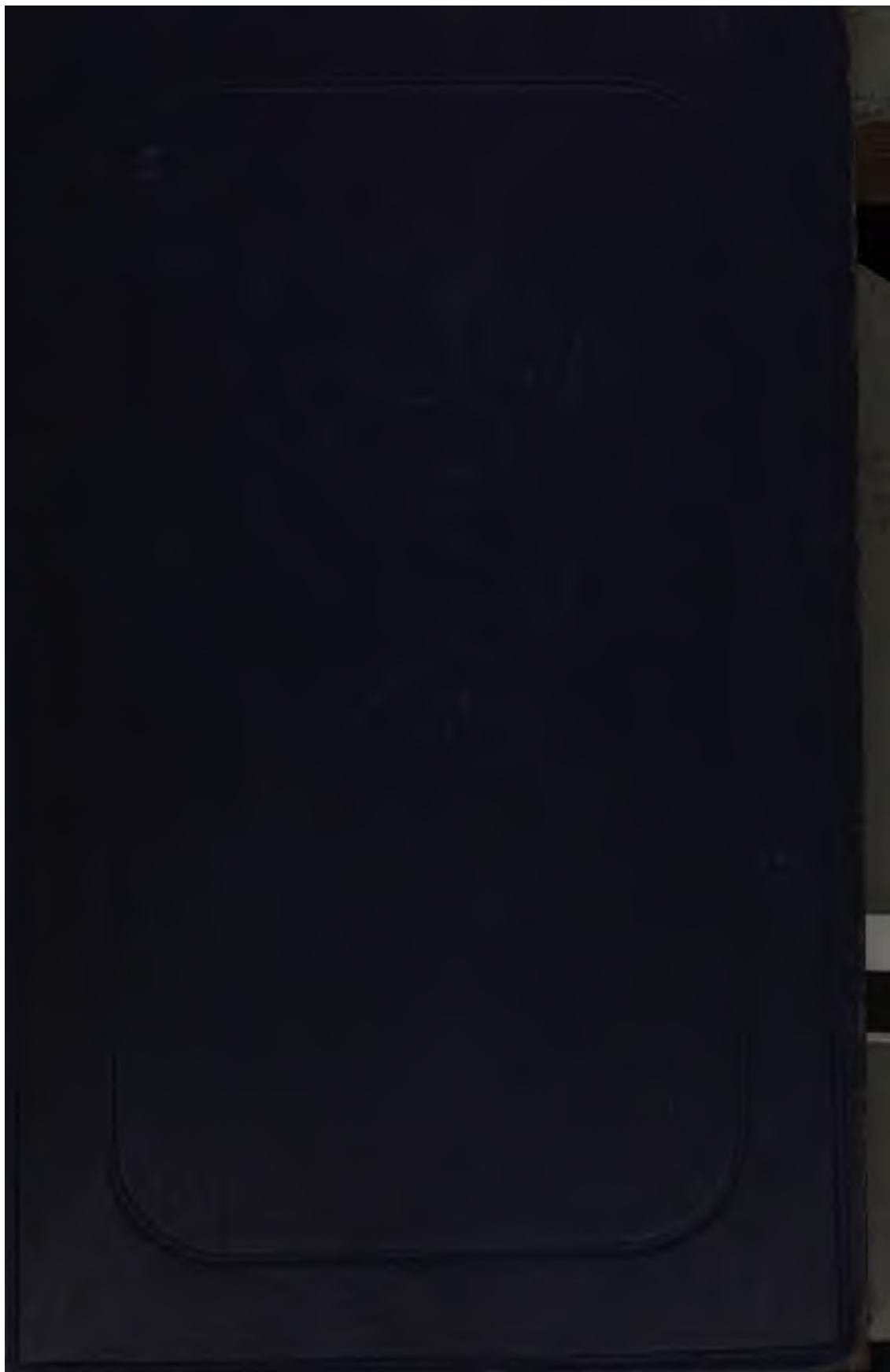
Google is proud to partner with libraries to digitize public domain materials and make them widely accessible. Public domain books belong to the public and we are merely their custodians. Nevertheless, this work is expensive, so in order to keep providing this resource, we have taken steps to prevent abuse by commercial parties, including placing technical restrictions on automated querying.

We also ask that you:

- + *Make non-commercial use of the files* We designed Google Book Search for use by individuals, and we request that you use these files for personal, non-commercial purposes.
- + *Refrain from automated querying* Do not send automated queries of any sort to Google's system: If you are conducting research on machine translation, optical character recognition or other areas where access to a large amount of text is helpful, please contact us. We encourage the use of public domain materials for these purposes and may be able to help.
- + *Maintain attribution* The Google "watermark" you see on each file is essential for informing people about this project and helping them find additional materials through Google Book Search. Please do not remove it.
- + *Keep it legal* Whatever your use, remember that you are responsible for ensuring that what you are doing is legal. Do not assume that just because we believe a book is in the public domain for users in the United States, that the work is also in the public domain for users in other countries. Whether a book is still in copyright varies from country to country, and we can't offer guidance on whether any specific use of any specific book is allowed. Please do not assume that a book's appearance in Google Book Search means it can be used in any manner anywhere in the world. Copyright infringement liability can be quite severe.

About Google Book Search

Google's mission is to organize the world's information and to make it universally accessible and useful. Google Book Search helps readers discover the world's books while helping authors and publishers reach new audiences. You can search through the full text of this book on the web at <http://books.google.com/>





A MANUAL
OF
NAVAL ARCHITECTURE.

FOR THE USE OF
OFFICERS OF THE ROYAL NAVY,
OFFICERS OF THE MERCANTILE MARINE,
SHIPBUILDERS AND SHIPOWNERS.

By W. H. WHITE,
ASSISTANT CONSTRUCTOR, ROYAL NAVY; INSTRUCTOR IN NAVAL ARCHITECTURE,
ROYAL NAVAL COLLEGE; MEMBER OF THE COUNCIL OF THE INSTITUTION
OF NAVAL ARCHITECTS; FELLOW OF THE ROYAL SCHOOL
OF NAVAL ARCHITECTURE.



LONDON:
JOHN MURRAY, ALBEMARLE STREET.
1877.

[The right of Translation is reserved.]

173. e. 94.

LONDON :
PRINTED BY WILLIAM CLOWES AND SONS, STAMFORD STREET
AND CHARING CROSS.



TO
VICE-ADMIRAL SIR HOUSTON STEWART, K.C.B.,
CONTROLLER OF THE NAVY,
This Book
IS RESPECTFULLY DEDICATED BY
HIS OBEDIENT SERVANT,
THE AUTHOR.



P R E F A C E.

THIS book has been undertaken in the hope that it may supply a want in the literature of naval architecture. Existing treatises have been written mainly for the use of those who desired to obtain the knowledge of the subject required in the practice of ship designing; in all, or nearly all, these books mathematical language is freely used, and without a considerable knowledge of mathematics no one can follow the reasoning. My work at the Royal Naval Collège has, however, shown me that outside the profession of the naval architect there are to be found very many persons, more or less intimately connected with shipping, who desire to obtain acquaintance with the principles of ship construction, but cannot obtain the information from existing text-books. Officers of the Royal Navy have repeatedly asked me to recommend a book which contained, in popular language, a comprehensive summary of the theory of naval architecture. Being unable to name such a book, and feeling confident that the desire expressed by officers of the Royal Navy will be shared by many officers of the mercantile marine, as well as shipbuilders, shipowners, and others, I decided to attempt the task now completed. I venture to hope that the work may be found acceptable also as an introduction for students to the more mathematical treatment of the subject contained in other works, and that even naval architects themselves may find some valuable information herein.

Throughout the book, so far as seemed possible, popular

language is employed; where mathematical language is used, it is of the simplest character. Explanations are given of many terms and mechanical principles, which need no explanation to readers possessing a good knowledge of mathematics; this course having been followed in order to assist the general reader, and render it unnecessary for him to turn to other books. The details of many important theoretical investigations are necessarily omitted; but the general modes of procedure are sketched, and the practical deductions are fully explained. These deductions are clearly of the greatest value to the readers for whom the book is mainly designed; and it has been my endeavour to make the survey of the theory of naval architecture, from this point of view, as complete as possible. Practical shipbuilding is not treated of; but in the Chapters on Strains, Structural Strength, and Materials for Shipbuilding, will be found an outline of the principles which govern the work of the shipbuilder, and an account of the principal features of the structures in various types of ships. The principal deductions from theory respecting the buoyancy, stability, behaviour, resistance, propulsion, and steering of ships, are set forth at length; practical rules are given for regulating the draught and stowage of ships, observing their behaviour at sea, and noting the dimensions of ocean waves. In every case numerous illustrations of these deductions are drawn from the particulars and performances of representative ships, belonging to English or foreign navies, and to the mercantile marine. Ships of war naturally receive most attention, the information respecting them being more exact and extensive than the corresponding facts for merchant ships; but the latter will also be found to receive considerable notice, the latest types of clipper sailing ships and mail steamers being described, and their performances discussed. The classes of war-ships for which particulars are given

range from the sailing ships of half a century ago up to the circular ironclads and central-citadel ships of the present day.

Apart from the illustrative use made of these facts, it is hoped that the mass of information thus brought together, some of which has never before been published, will add to the value of the book. Not only naval officers, but naval architects, may be glad to have brought together in a compact form, and made easy of reference, much information that either lies scattered or is inaccessible elsewhere. To the notice of naval architects also I would venture to recommend the Chapters on Steam Propulsion and Steering.

One great object which I have kept in view throughout has been to endeavour to awaken in the minds of seamen an intelligent interest in the observations of deep-sea waves and the behaviour of ships. Upon such observations further progress in the theory of naval architecture largely depends; and although much has been done of late years, especially by officers of the Royal Navy, still more remains to be done.

The success which has already attended my endeavours to popularise a few out of the many problems of ship design, in lectures delivered at the Royal Naval College to naval officers, leads me to hope that a similar mode of treatment applied, as in the present work, to the whole range of naval architecture may be welcomed by a wider circle of readers. One incentive to undertake the book was found in the requests made by many officers who attended the lectures that they might be published; but it seemed preferable to enlarge their scope considerably before publication, and although much of the material used for the lectures has been embodied in this book, it considerably amplifies and extends the treatment of the subjects included in the four courses of lectures.

Much of the information contained in this book has necessarily been drawn from the works of other writers; in all such cases I have endeavoured to acknowledge the sources of information. In a few cases the substance of papers of my own, previously published, has been used; these cases are also mentioned in the text, with one exception. While the book was passing through the press, some of the materials of Chapters V. and VI. were used in a lecture delivered at the Royal United Service Institution.

In conclusion I desire to acknowledge the valuable advice on many matters of difficulty given me by Mr. Crossland, Chief Constructor of the Navy; and the great assistance, in the revision for the press, kindly rendered by Mr. Philip Watts, of the Controller of the Navy's Department, Admiralty.

W. H. WHITE.

LONDON, 1877.



CONTENTS.

CHAPTER I.

THE DISPLACEMENT AND BUOYANCY OF SHIPS.

	PAGE
Definitions of displacement and buoyancy	1
Useful displacement, or carrying power	3
Approximate rules for estimating displacement	4
Curves of displacement: their construction and uses	7
Curves of tons per inch immersion: their construction and uses	9
Changes in draught of water produced by the passage of ships from the sea to rivers or docks	11
Reserve of buoyancy for various types of ships	12
Submarine vessels: fundamental principles of construction	14
Foundering of ships which are "swamped"	16
Water-logged ships	17
Foundering of ships which have bottoms penetrated	18
Principles of watertight subdivision of ships—	
By transverse bulkheads	21
By longitudinal bulkheads	25
By decks or platforms	28
Watertight subdivision in modern war-ships	30
Usefulness of double bottoms	33
Collision between <i>Iron Duke</i> and <i>Vanguard</i>	35
Freeboard: rules for	36
Load-draught: recent legislation respecting	37

CHAPTER II.

THE TONNAGE OF SHIPS.

Origin and great variety of tonnage measurements	39
Displacement tonnage: best measure for war-ships	41
Dead-weight measurement: proposed use of	42
Builders' old measurement	43
Reasons for the disuse of B.O.M.	46

	PAGE
Yacht measurement : Thames rule	48
" " Other English rules	49
" " New York rule	50
Register tonnage (law of 1854)	51
Approximate rules for estimating gross register tonnage	53
Objections to existing law, as applied to steamers	55
Danube rule	57
Suez Canal measurement	57
Freight tonnage	59

CHAPTER III.

THE STATICAL STABILITY OF SHIPS.

Condition of ships floating freely in still water	60
Condition of ships held at a steady inclination	61
Stable, unstable, and indifferent equilibrium	63
Statcal stability defined	63
Metacentre for transverse inclinations, defined	64
Stiffness, crankness, steadiness : meanings of the terms	65
Ship steadily heeled comparable to a pendulum	66
Metacentric heights for war-ships	66
Conditions governing the vertical position of the metacentre	68
Approximate rules for estimating positions of centre of buoyancy and transverse metacentre	70
Changes in stiffness produced by variations in forms, proportions, and lading of ships	72
Stability of a cigar-ship	75
Stability of a submarine vessel	76
Inclining experiment to determine vertical position of the centres of gravity of ships	77
Effect upon stability of free water in holds of ships	81
Usefulness of watertight subdivision in maintaining stability	83
Effect upon stability of additions or removals of weights	84
" " raising or lowering weights	86
Transverse and longitudinal stability contrasted	88
Estimates of change of trim—	
When weights on board a ship are shifted	88
When weights are added or removed	90
Stability of ship partially water-borne and partly aground	92
Atwood's formula for statcal stability at finite inclinations	94
Curves of stability : method of constructing	96
" " causes influencing form and range	97
" " relative importance of beam and freeboard	98
" " examples for typical war-ships	101

CHAPTER IV.

THE OSCILLATIONS OF SHIPS IN STILL WATER.

	PAGE
Oscillations of ships compared with those of pendulums	103
Hypothetical case of unresisted rolling	104
Necessity for considering the distribution of weights	105
Angular velocity, accelerating force, and moment of inertia	107
Instantaneous axis about which a ship rolls	109
Conservation of motions of translation and rotation	111
Motion of metacentre during rolling	112
Formula for period of unresisted rolling	112
Changes in period produced by changes in stiffness and moment of inertia	113
Periods and metacentric heights for typical war-ships	114
Rules for estimating alterations of period produced by changes of stowage	116
Dipping oscillations which accompany rolling	118
Resistance of water to rolling of ships	120
Subdivision of resistance into its component parts	120
Rolling experiments in still water: mode of conducting and deductions from observations	122
Bilge-keels: means of increasing resistance to rolling	125
Important influence of surface disturbance	127
Rate of extinction of still-water oscillations	129
Rolling experiments as checks upon stowage	131
Dynamical stability: defined	131
" " mode of estimating	133
" " Moseley's formula for	134
Oscillations produced by the action of gusts or squalls of wind on rigged ships	135
Comparative safety of <i>Captain</i> and <i>Monarch</i>	137
Mastless ships little affected by squalls	140

CHAPTER V.

DEEP-SEA WAVES.

Attempts to frame theories for wave motion	141
Conditions assumed in trochoidal theory	141
Distinction between motion of wave form and motion of particles of water	142
Construction of trochoidal profiles of waves	143
Definitions of lengths, heights, and periods	144
Advance of wave form produced by orbital motion of particles	145

	PAGE
Internal structure of waves	147
Variations in direction and intensity of fluid pressure incidental to wave motion	151
Maximum slopes of waves	153
Variations in "virtual weight" of ships due to heaving	154
Necessity for careful observations of ocean waves	156
Methods of conducting such observations	157
Summary of recorded maximum dimensions of waves	164
Sources of error in estimating heights of waves	165
Limiting ratios of height to length	166
Formulae connecting lengths and speeds of waves	167
Comparison of theoretical estimates with actual observations of wave lengths and periods	169
Connection between force of wind and size of waves	171
Want of a complete theory of wave genesis	173
Persistence of wave lengths over long distances	176
Phenomena of a "confused sea"	178
Utilisation of ocean wave power	180

CHAPTER VI.

THE OSCILLATIONS OF SHIPS AMONG WAVES.

Rolling and pitching only need to be considered	181
Early theories of rolling	182
Modern theory of rolling due to Mr. Froude	182
Instantaneous position of equilibrium for a ship floating among waves	184
The effective wave slope	185
Oscillations of ships primarily due to variations in direction of fluid pressure among waves	187
Case of quick-moving vessels: rafts, monitors, &c.	188
Case of very slow-moving vessels	190
Fundamental assumptions of modern theory	192
Heavy rolling results from approximate synchronism of period of still-water oscillation of ships, and half-period of waves	194
Examples of such heavy rolling from actual ships	198
Case of "permanent oscillations" of ships among waves	200
Use of pendulums to illustrate influence upon the behaviour of ships of the ratio of their periods to wave periods	203
Summary of observed performances at sea of typical war-ships	205
Changes in speed and course affect behaviour of ships	208
Phases of oscillation of ships among waves	209
Considerations affecting the safety of ships at sea	212
Special dangers of rigged ships	213
Heaving motion, may assist in capsizing ships	215

CONTENTS.

xiii

	PAGE
Fluid resistance limits range of oscillation	216
Bilge-keels assist to steady ships	219
Influence of under-water form upon rolling	222
Deck resistance in ships of low freeboard	223
Sails assist to steady ships	224
Causes of pitching and 'scending	225
Theoretical treatment of subject	227
Considerable motion of extremities may accompany small angles of longitudinal oscillations	228
Fluid resistance affects pitching motions	230
Longitudinal distribution of weight also important	231
Deck resistance to pitching in ships of low freeboard	231
Periods of pitching are modified by wave periods	233

CHAPTER VII.

METHODS OF OBSERVING THE ROLLING AND PITCHING MOTIONS OF SHIPS.

Care required to ensure accuracy	234
Necessity for such observations	235
Pendulum observations, and their errors	236
Spirit-levels, cannot be trusted	240
Gyroscopic instruments, and their drawbacks	241
M. Normand's instrument	245
Batten instruments: various arrangements of	247
Automatic instruments	251
Description of Mr. Froude's automatic instrument	252
Simultaneous observations of behaviour of ships and character of waves much needed	256

CHAPTER VIII.

THE STRAINS EXPERIENCED BY SHIPS.

Necessity for careful study of subject	258
Classification of principal strains	259
Longitudinal bending moments (hogging and sagging):—	
Due to unequal distribution of weight and buoyancy	260
Method of estimating bending moments	262
Curves of weight, buoyancy, loads and bending moments, construction and uses of; with examples	264
Still-water bending moments of her Majesty's ship <i>Minotaur</i> when fully laden, and when floating light	266

	PAGE
Longitudinal bending moments (continued):—	
Still-water bending moments for her Majesty's ship <i>Devastation</i>	268
" " " for her Majesty's ship <i>Vanguard</i>	270
Bending moments due to longitudinal fluid pressure	271
Extreme cases of support for ships among waves	272
Corresponding bending moments for her Majesty's ships <i>Minotaur</i> and <i>Devastation</i>	274
Rapid changes of strain among waves	277
Maximum bending moments for typical ships	278
Bending moments of ships ashore	280
Transverse strains experienced by ships when—	
Resting on the keel only in dock or ashore	283
Afloat in still water	285
Rolling among waves	286
Strains incidental to propulsion—	
By sails	289
By screws or paddles	293
Local strains, produced by—	
Concentrated load or support	294
Grounding, with special reference to iron ships	297
Loads on decks	300
Collision; with special reference to ramming and the construction of ram-bows	300
Propulsion; with details of stern strengthenings in screw-steamers	305

CHAPTER IX.

THE STRUCTURAL STRENGTH OF SHIPS.

Gradual development of structural arrangements	309
Features common to structures of all ships	310
Resistance to principal strains alone considered	311
Ultimate effect of longitudinal bending strains	312
Parts of structure contributing to the longitudinal strength	312
Construction of "equivalent girder" sections	313
Principles of the strength of beams and girders	316
Application of these principles to longitudinal strength of ships	320
Straining effect of hogging and sagging moments	321
Longitudinal strength contributed by—	
Upper decks of wood, iron, and composite ships	323
Bottoms below the bilges	325
Longitudinal framing of special iron ships	328
Skins and riders of ordinary wood ships	332

	PAGE
Longitudinal strength contributed by—(continued)	
Skins of composite ships	335
Skins of diagonally built wood ships	336
Skins of iron ships	337
Special arrangements of shallow-draught vessels	338
Distribution of the material, in the vertical sense, to resist longitudinal bending	341
Distribution of the material, in the longitudinal sense	343
Local requirements influence distribution of material	345
Length, breadth, and depth of ships must all be considered in determining on necessary longitudinal strength	345
Maximum longitudinal strains of merchant ships	347
" " " of ironclad war-ships	349
Provision of transverse strength	351
Strength of transverse frames or ribs in wood and iron ships	352
Partial bulkheads of iron ships	353
Transverse framing of ironclads and swift cruisers	354
Beams and pillars as transverse strengtheners	356
Beam-knees and beam-end fastenings	358
Transverse bulkheads considered as strengtheners	360

CHAPTER X.

MATERIALS FOR SHIPBUILDING: WOOD, IRON, AND STEEL.

Wood, iron, and steel now used	363
Remarkable progress of iron shipbuilding	364
Great increase in sizes and speeds of ships of late years, a result of the use of iron hulls	366
Iron ships superior to wood in the combination of lightness with strength	369
Weights of hull and carrying power of ships	370
Resistance of single pieces of wood and iron to tensile and compressive strains	371
Table of weights and tensile strengths of timber	374
Table of compressive strengths of timber	376
Moduli of elasticity of iron and timber	378
Resistance of combinations of wood or iron to tensile and compressive strains	378
Modes of scarphing timbers in wood ships	380
Shift of butts in assemblages of wood planks or ribs	382
Butt and lap joints of iron plates or bars	383
Resistance to bending of wood and iron beams	384
Varieties of sectional forms possible with iron beams	385

	PAGE
Approximate rules for strengths of wood and iron deck beams ..	387
Advantages of flanged forms of manufactured iron	388
Comparative durability of wood and iron ships	389
Average durability of well-built wood ships	391
Rapid decay of many wood ships	392
Great durability of iron ships when properly treated	393
Corrosion a special danger of iron skins	394
Examples of durability of iron ships	395
Precautions against corrosion	397
Circumstances affecting rate of corrosion	399
Admiralty regulations for preservation of iron ships	400
Iron ships more easily and cheaply built and repaired than wood ships	401
Cost of maintenance of wood and iron ships	404
Relative first cost and after earnings of wood and iron ships ..	406
Iron ships, properly subdivided, safer than wood ships	406
Fouling of bottoms of iron ships: plans for preventing	409
Antifouling properties of copper sheathing	411
Use of Muntz metal and zinc sheathing	412
Comparative wear of various metals in sea-water	414
Metal sheathing for bottoms of wood ships: modes of attaching ..	414
Copper sheathing for iron ships	415
Zinc sheathing for iron ships	418
Suitability of iron hulls for unarmoured war-ships	419
Use of steel for shipbuilding: advantages and drawbacks	421
Recent introduction of mild steel for ships of the Royal Navy ..	424
Savings in weight of hull of steel ships	425

CHAPTER XI.

THE RESISTANCE OF SHIPS.

Early theories of resistance	426
Modern or stream-line theory	427
Frictional, direct, eddy and wave-making resistance defined ..	428
Erroneous assumptions of early theories	429
General sketch of stream-line theory for bodies wholly submerged in frictionless fluid	431
Wave-making resistance very important in ships and bodies partly immersed	434
Fallacies respecting resistance, explained by means of stream-line theory	437
Frictional resistance experienced by ships	438
Mr. Froude's experiments on friction	439
Method of estimating frictional resistance of ships	440

	PAGE
Eddy-making resistance: usually small	441
Wave-making resistance	442
Effect of lengths and form of entrance and run upon wave-making resistance	444
Mr. Scott Russell's wave-line theory of resistance	447
Professor Rankine's mode of estimating wave-making resistance ..	449
Mr. Froude's recent experiments on the subject	450
Limiting speeds for economical propulsion of ships	451
Experiments with models of typical merchant ships	452
Experiments with her Majesty's ship <i>Greyhound</i>	453
Economical propulsion not the governing condition of designs for war-ships	454
Reasons for adoption of great ratios of length to breadth in merchant ships	455
Restrictions placed on lengths of war-ships by necessity for stiffness and handiness	456
Summary of deductions from recent experiments on resistance ..	458
Total resistances of certain ships at various speeds	459
Great value of Mr. Froude's model experiments	461
Method of estimating resistances of ships from experiments with models	463
Resistance in a seaway	466
Air resistance	467

CHAPTER XII.

PROPULSION BY SAILS.

Experience best guide in arrangement of sail plans	470
Speeds and normal pressures of winds	471
Oblique action of wind on sails	473
Actual and apparent direction and velocity of wind	474
Condition of ships sailing on a wind	476
Leeway and lateral resistance	478
Balance of sail	483
Plain sail of various classes of vessels	485
Comparative sail spreads in vessels of different sizes	487
Longitudinal distribution of sails, and determination of centre of effort of sails	491
Stations of masts	494
Rake of masts	495
Sail areas on various masts	497
Handiness in manœuvring, influenced by position of centre of effort in relation to centre of gravity	497

	PAGE
Vertical distribution of the sails	498
Stiffness and power to carry sail	500
Forms and proportions of sailing ships; early and recent types compared	502
Forms and proportions of yachts	504

CHAPTER XIII.

STEAM PROPULSION.

Rapid development of steam navigation	506
Problem of steam-ship design	508
Useful work of marine engines	510
Indicated horse-power of marine engines	511
Nominal horse-power of marine engines; various rules for	512
Ratios of indicated horse-power to weight, and rate of consumption of coal for various types of engines	515
Advantages of economical consumption of coal	517
Efficiency of marine engines	518
Efficiency of propellers	519
Fundamental principle of action of propellers	520
Water-jet propellers: advantages and disadvantages	521
Paddle-wheels: advantages and disadvantages	525
Screw-propellers: advantages and disadvantages	529
Multiple screws and twin-screws	536
Estimates of engine-power for new steamers	539
Admiralty coefficients of steam-ship performance	540
Use of Mr. Froude's scale of comparison	545
Economical propulsion, favoured by adoption of suitable forms and proportions, when possible	549
Steaming capabilities of long and short ironclads	550
Steaming capabilities of circular ships	552
Increase in size favours economical propulsion	555
Special features of swift steam-launches	560
Tabular statement of expenditure of engine-power in various classes of ships	565

CHAPTER XIV.

THE STEERING OF SHIPS.

Different modes of steering	567
Ordinary and balanced rudders	568
Fluid pressure on rudder: cause and measure of	570

	PAGE
Steerage of sailing, paddle, and jet-propelled ships	573
Steerage of screw-ships	574
Force required on tiller-end to hold a rudder over	578
Work to be done in putting the rudder over	580
Advantages of balanced rudders	581
Steam and hydraulic steering gear	582
Turning effect of rudders upon ships	584
Conditions governing readiness of ships to answer their helms ..	586
Initial motions of ships in turning	588
Forces operating upon ships while turning	589
Causes of heeling and change of trim during an evolution	591
Form of path, and space traversed by steam-ships when turning ..	593
Effect of changes in time of putting helm hard over	594
Effect of increase in rudder area	595
Variation in times of turning with speeds of ships	595
Effect of increase in helm angle	596
Comparative efficiency of broad and narrow rudders	597
Rules for proportioning rudder areas	598
Forms of rudders in common use	600
Rankine's rudder for screw-steamers	601
Herr Schlick's rudder	601
M. Joessel's rudder	602
Mr. Gumpel's rudder	602
Mr. Lumley's rudder	603
Bow rudders	603
Steering screws and water jets	605
Drop and auxiliary rudders under counters	606
Steering blades	607
Jury rudders	607
Steering by propellers in single-screw ships	608
" " with Fowler's paddle	608
" " in twin-screw ships, with details of turning trials	609
" " in jet-propelled ships	612
Manœuvring in a seaway	613

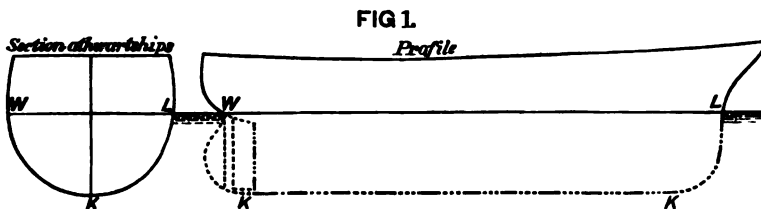
INDEX	614

NAVAL ARCHITECTURE.

CHAPTER I.

THE DISPLACEMENT AND BUOYANCY OF SHIPS.

A SHIP floating at rest in still water must displace a volume of water having a weight equal to her own weight. The truth of this fundamental condition may be easily demonstrated. Let Fig. 1 represent the ship (in profile view and athwartship section), WL being the surface of the water. If it is supposed that the water surrounding the ship



becomes solidified, and that the ship is then removed, there will remain a cavity representing in form and volume the water displaced by the ship: this is termed the "volume of displacement" (or, shortly, the "displacement") of the ship, being represented in the diagrams by WKL. If the cavity is then filled up to the level of the surface WL with water of the same density as that in which the ship floated, and afterwards the surrounding water again becomes liquid, there will obviously be no disturbance or change of level in consequence of the

substitution of the water for the ship. Therefore the total weight of water poured into the cavity—that is, the total weight of water displaced by the ship—must equal her weight.

This fundamental law of hydrostatics applies to all floating bodies, and is equally true of wholly submerged vessels as of ships (like that in Fig. 1) of ordinary form, having only a portion of their volume immersed.

Ships which are of equal weight may differ greatly in form and dimensions, and consequently the forms of their respective displacements will differ; but when they are floating in water of the same density, the volumes must be equal to one another, because the weights of the ships are equal. On the other hand, when a ship passes from water of one density to water of another density, say from the open sea to a river where the water is comparatively fresh, her volume of displacement must change, because the weight of water displaced must be the same in both cases. Under all circumstances the volume of displacement, multiplied by the weight per unit of volume of the water in which the ship floats, must equal the weight of the ship. It is usual to express the volume in cubic feet, and for sea-water to take 64 lbs. as the weight of a cubic foot: so that the weight of the ship in tons multiplied by thirty-five gives the number of cubic feet in the volume of displacement when she floats in sea water.

At every point on the bottom of a ship afloat, the water pressure acts perpendicularly to the bottom. This normal pressure at any point depends upon the depth of the point below the water surface; and it may be regarded as made up of three component pressures. First, a vertical pressure; second, a horizontal pressure acting athwartships; third, a horizontal pressure acting longitudinally. Over the whole surface of the bottom a similar decomposition of the normal fluid pressures may be made; but of the three sets of forces so obtained, only those acting vertically are important in a ship at rest. The horizontal components in each set must obviously be exactly balanced amongst themselves, otherwise

the ship would be set in motion, either athwartships or lengthwise. The sum of the vertical components must be balanced by the weight of the ship, which is the only other vertical force; this sum is usually termed the "buoyancy;" it equals the weight of water displaced, and the two terms "buoyancy" and "displacement" are often used interchangeably.

The total weight of a ship may be subdivided into the "weight of the hull," or structure, and the "weight of lading." The latter measures the "carrying power" of the ship, and is therefore frequently termed the "useful displacement." Useful displacement for a certain degree of immersion is simply the difference between the total displacement and the weight of the hull: so that any decrease in the weight of hull leads to an increase in the carrying power. If the ship is a merchantman, savings on the hull enable the owner either to carry more cargo in a vessel of a specified size or else to build a smaller vessel to carry a specified cargo. If the ship is a man-of-war, such savings on the hull render possible increase in the offensive or defensive powers, or in the coal supply, engine power, or speed; or else enable certain specified qualities to be obtained on smaller dimensions than would otherwise be practicable. Hence appears the necessity for careful selection of the best materials and most perfect structural arrangements, in order that the necessary strength may be secured in association with the minimum of weight. It is in this direction that all recent improvements in shipbuilding have tended, and the use of iron hulls instead of wood has greatly facilitated progress. For example, in wooden ships of war it is common to find the weight of hull equal to one-half of the total displacement; whereas in iron ships the hull weighs only 30 or 40 per cent. of the displacement. Iron merchant ships also, even of the largest size, frequently have hulls weighing only one-third of the displacement. Hereafter a description will be given of the principal structural improvements to which the savings in weight of hull are due.

Having given the draught of water to which it is pro-

posed to immerse a ship, the volume of her immersed part determines the corresponding displacement, and this displacement can be calculated with exactitude from the drawings of the ship. This is the method adopted by the naval architect; but any details of the method would be out of place here. At the same time an approximate rule by which an estimate of the displacement of the ship may be rapidly made may have some value. Assuming that the length of the ship at the load-line is known (say L), also the breadth extreme (B), and the mean draught (D), the product of these three dimensions will give the volume of a parallelopipedon circumscribing the immersed portion of the ship. This may be written:—

$$\text{Volume of parallelopipedon} = V \text{ (cubic feet)} = L \times B \times D.$$

The volume of displacement may then be expressed as a *percentage* of the volume (V) of the parallelopipedon; and for the undermentioned classes of ships, the following rules hold:—

Classes of Ships.	Displacement equal to Percentage of Volume (V).
1. Fast steamships, such as her Majesty's yachts or the Holyhead packets	43 to 46 per cent.
2. Swift steam-cruisers of Royal Navy (<i>Inconstant</i> and <i>Volage</i> classes); corvettes and sloops	46 to 52 per cent.
3. Gun-vessels of Royal Navy; merchant steamers (common forms)	55 to 60 per cent.
4. Old classes of unarmoured steam line-of-battle ships and frigates in Royal Navy	50 to 55 per cent.
5. Early types of ironclads in Royal Navy (<i>Warrior</i> and <i>Minotaur</i> classes)	55 per cent.
6. Modern types of rigged ironclads, with moderate proportions of length to breadth	60 to 62 per cent.
7. Mastless sea-going ironclads (<i>Devastation</i> class); cargo-carrying steamers of moderate speed.	65 to 70 per cent.

This table may be found serviceable in rapidly approximating to the displacement of a ship for which the principal dimennsios are known; although it makes no pretensions to completeness or exactness. Taken in connection with

previous statements of the proportions which the weights of hulls in different classes of ships bear to the total displacements, it will enable the useful displacements, or carrying powers, of vessels to be ascertained with fair approximation, when their class, intended speed, &c. are known.

For example, take a wood-built corvette of the *Encounter* class in the Royal Navy. Her dimensions are:—Length = $L = 220$ feet; breadth = $B = 37$ feet; mean draught = $D = 15\frac{3}{4}$ feet.

Hence for parallelepipedon, volume is given by

$$V = L \times B \times D = 220 \times 37 \times 15\frac{3}{4} = 128,205 \text{ cubic feet.}$$

By rule 2 in foregoing table, taking the upper limit, as these vessels have only moderate speed—

$$\begin{aligned} \text{Displacement (in cubic feet)} &= 52 \text{ per cent. of } V \\ &= \frac{52}{100} \times 128,205 = 66,660 \text{ cubic feet.} \end{aligned}$$

$$\text{Displacement (in tons)} = 66,660 \div 35^* = 1904 \text{ tons.}$$

The displacement of the class (see Navy List) is about 1930 tons. Being built of wood, the hull of such a vessel will weigh about one-half the displacement; the carrying power being consequently about one-half also. So that, approximately, it may be said—

Useful displacement, or total carrying power = 950 tons.

This is approximately the total weight available, therefore, in a vessel of the *Encounter* class, for engines, boilers, coals, stores, equipment, and armament; and the disposal of this available weight in the manner that will secure the greatest efficiency for the service intended is a matter requiring careful consideration.

As another example, take the case of one of her Majesty's armoured frigates, masted and rigged, such as the *Alexandra*, the most powerful ship of that class yet completed. Her

* See page 2 as to weight of sea water.

dimensions are :—Length = $L = 325$ feet; breadth = $B = 63\frac{3}{4}$ feet; mean draught = $D = 26\frac{1}{4}$ feet.

Hence

$$V = L \times B \times D = 325 \times 63\frac{3}{4} \times 26\frac{1}{4} = 543,156.$$

Also, by rule 6 in the table—

$$\left. \begin{array}{l} \text{Displacement} \\ \text{(approximate)} \end{array} \right\} = 60 \text{ to } 62 \text{ per cent. of } V = 61 \text{ (say)}$$

$$= \frac{61}{100} \times 543,156 = 331,290 \text{ cubic feet.}$$

$$\text{And displacement in tons} = 331,290 \div 35 = 9465 \text{ tons.}$$

On reference to the Navy List, the displacement will be found to be 9492 tons; so that the approximation is fair.

As to the “useful displacement” of the *Alexandra* type, it will be remembered that about 40 per cent. of the displacement is required for the hull in such vessels; so that 60 per cent.—or about 5600 tons—would be a fair approximation to the total carrying power, and this weight is what the designer has in his power to distribute as he thinks best, over armour, guns, machinery, coals, and all other parts of the equipment. These examples will probably suffice to show the reader unfamiliar with the exact processes for calculating the displacement of ships how he may approximate to that displacement.

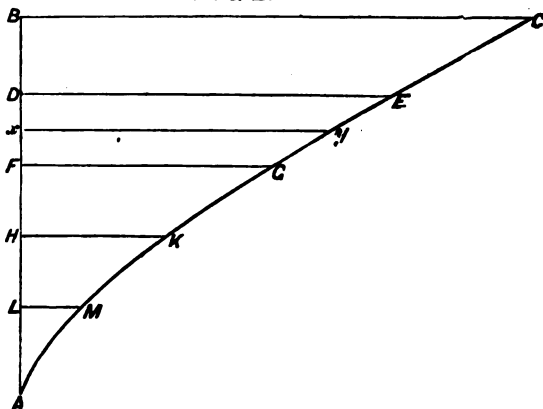
The percentages stated in the foregoing table are technically known as “coefficients of fineness,” expressing, as they do, the extent to which the immersed part of the ship is “finned” or reduced from the parallelopipedon that can be circumscribed about it. As measures of the comparative fineness of form of any two ships, it is, perhaps, more satisfactory to take the coefficients expressing the ratios of the respective volumes of displacement to the volumes of the right cylinders described upon the greatest immersed athwartship sections of the ships, and having lengths equal to the lengths of the ships along the water-lines. But the determination of these last-named coefficients involves the use of the drawings of the ships in order to determine the areas of the immersed midship sections; and they are of



greater use to the naval architect than to the naval officer. The rules given above are therefore more likely to be suited for use in cases where a fair approximation to accuracy is sufficient than if they were based upon the more exact coefficients of fineness.

Ships vary in their draught of water and displacement as the weights on board vary, and in cargo-carrying merchant vessels this variation is most considerable, their displacement without cargo, coals, or stores, often being considerably less than one-half of the load displacement. In ships of war the variation in displacement is not usually so great, but even in them the aggregate of consumable stores reaches a large amount, and when they are out of the ship, she may float 2 or 3 feet lighter than when fully laden. Naval architects have devised a plan by which, without performing a calculation for every line at which a ship may float, it is possible to ascertain the corresponding displacement by a simple measurement. Fig. 2 illustrates

FIG 2.



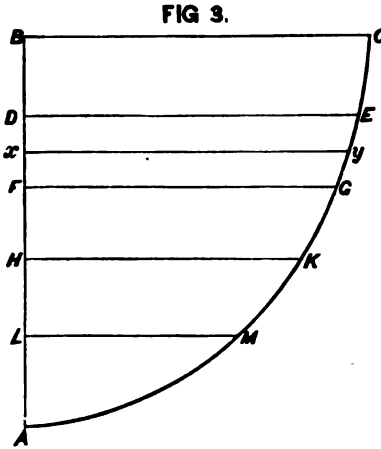
one of the "curves of displacement" drawn for this purpose; it is constructed as follows. The displacements up to several water-lines are obtained by direct calculation from the drawings of the ship, in the manner before mentioned. Then a line AB is drawn, the point A representing the under side of the keel, and the length AB representing the "mean draught" of the ship when fully laden; this

mean draught being half the sum of the draughts of water forward and aft. Through B a line BC is drawn at right angles to AB, the length BC being made to represent, to scale, the total displacement of the ship when fully laden: an inch in length along BC representing, say, 100 tons of displacement. Suppose the displacement to have been also calculated up to another water-line (represented by DE in the diagram) parallel to and at a known distance below the load-line (BC). Then on DE a length is set off representing this second displacement on the same scale as was used for BC. Similarly the lengths FG, HK, and so on, are determined, and finally the curve CEG . . . A is drawn through the ends of the various ordinates. When this curve is once drawn, it becomes available to find the approximate displacement for any draught of water at which the ship may float, supposing that she does not very greatly depart in *trim* from that at which she floats when fully laden.* For instance, suppose the mean draught for which the displacement is required to be 4 feet lighter than the load-draught. Set down Bx representing the 4 feet, on the same scale on which AB represents the mean load-draught. Through x draw xy perpendicular to AB to meet the curve, and the length xy (on the proper scale) measures the displacement at the light draught. This brief explanation will doubtless render obvious the great practical usefulness of curves of displacement, which always form part of the calculations attached to the designs of ships for the Royal Navy.

Another problem that frequently occurs is the determination of the increased immersion which will result from putting a certain weight on board a ship when floating at a known draught, or the decreased immersion consequent on removing certain weights. Here again the naval architect resorts to a graphic method in order to avoid numerous

* By "trim" the naval architect means the *difference in draught* at the bow of a ship from that at the stern.

independent calculations. The diagram, Fig. 3, represents a "curve of tons per inch immersion"; the horizontal measurement from the base-line AB representing (on a certain scale) the number of tons which would immerse the ship one inch when she is floating at the draught corresponding to the ordinate along which the measurement is made. The construction of this curve is very similar to that of the curve of displacement in Fig. 2, the successive points on the curve being found for the equidistant water-lines, BC, DE, FG, &c., by direct calculation from the drawings of the ship; and the length of the ordinate xy determining the number



of tons required to immerse the ship one inch when floating at any mean draught, Ax . In this case also it is to be understood that at the various mean draughts considered there are no considerable departures in trim from that of the fully laden ship.

It will be observed in the diagram that the upper part of the curve of tons per inch is very nearly parallel to the base-line AB; this simply indicates the well-known fact that, in the neighbourhood of the deep load-line of ships of ordinary form, the sides are nearly upright, and there is little or no change in the form of the horizontal sections. For all practical purposes, in most ships, no great error is involved in assuming that twelve times the weight which would sink the ship one inch below her load-line will sink her one foot, or that a similar rule holds for the same extent of lightening from the load draught. In fact, it is very common to find this rule holding fairly for 2 feet

on either side of the fully laden water-line. A rule which gives a fair approximation to the tons per inch immersion at the load-line, in terms of the length and breadth of the ship, has therefore considerable value. Using the same symbols as before, viz.:—

$$\begin{aligned} \text{Length of the ship at the load-line} &= L \text{ (feet),} \\ \text{Breadth} \quad \quad \quad \quad \quad \quad \quad &= B \quad \quad \quad \quad \quad \quad \quad \end{aligned}$$

we should have,

$$\left. \begin{array}{l} \text{Area of circumscribing} \\ \text{parallelogram . . .} \end{array} \right\} = L \times B = A \text{ (square feet).}$$

And then the following rules express, with a considerable amount of accuracy, the number of tons required to immerse or emerse the ship one inch when floating at her load draught:—

- | | Tons per Inch. |
|---|---|
| 1. For long fine ships of great speed | $= \frac{1}{600} \times A.$ |
| 2. For ships of ordinary form (including probably the
great majority of vessels) | $\left. \begin{array}{l} \\ \end{array} \right\} = \frac{1}{560} \times A.$ |
| 3. For ships of great beam in proportion to length (say
less than 5 beams in length) | $\left. \begin{array}{l} \\ \end{array} \right\} = \frac{1}{500} \times A.$ |

One or two examples of these rules may prove useful. The *Invincible* class of the Royal Navy are ships coming under rule 2, being ships of ordinary form. Their dimensions are:—Length = L = 280 feet; breadth = B = 54 feet.

$$\left. \begin{array}{l} \text{Area of circumscribing} \\ \text{parallelogram . . .} \end{array} \right\} = A = 280 \times 54 = 15,120 \text{ sq. ft.}$$

$$\therefore \text{ Tons per inch at load-line} = \frac{1}{560} \times 15,120 = 27 \text{ tons.}$$

This is nearly exact for these vessels.

As a second example, take her Majesty's ship *Devastation*, a short, broad vessel, coming under rule 3. Her dimensions are:—Length = L = 285 feet; breadth = B = 62½ feet.

$$\text{Area} = A = 285 \times 62\frac{1}{2} = 17,740 \text{ square feet.}$$

$$\text{Tons per inch at load-line} = \frac{1}{500} \times 17,740 = 35\frac{1}{2} \text{ tons (nearly).}$$

The actual "tons per inch" for this ship is about 36½ tons.

The second rule in the foregoing table is that which should be applied in most cases.

It is easy to see how the curves of tons per inch, and the curves of displacement constructed for the case of ships floating in sea-water, may be made use of in order to determine the change of draught produced by the passage of a ship into a river, or estuary, or dock, where the water is comparatively fresh. For example, sea-water weighs 64 lbs. per cubic foot, whereas in one of the London docks the water weighs about 63 lbs. per cubic foot—or $\frac{1}{64}$ part less than sea-water. Since the total *weight* of water displaced by the ship must remain constant, it is only necessary to make the following corrections:—

Difference between weight of sea-water and river-water for the volume immersed up to the draught at which the ship floats at sea

$$= \frac{1}{64} \times \text{weight of ship} = \frac{1}{64} W.$$

Tons per inch immersion at this draught in river-water
 = $\frac{63}{64}$ tons per inch for sea-water = $\frac{63}{64} T$.

∴ Increase in draught of water when ship floats in river-water

$$= \frac{1}{64} \times W \div \frac{63}{64} T = \frac{W}{63 T} \text{ (inches).}$$

For any other density of water than that assumed above, the correction would be made in a similar manner. As a numerical example, take a ship having the following particulars:—Weight = $W = 6000$ tons; tons per inch at load-draught in sea-water = $T = 30$.

Increased draught on entering London docks, as compared with her draught at the Nore } = $\frac{6000}{63 \times 30} = 3\frac{1}{3}$ in.

The draught being observed when the vessel is about to leave the sea, the curves of displacement and tons per inch will furnish the corresponding values of W and T in the foregoing expressions.

The converse case, where a ship, on passing from a dock

or river to the sea, floats at a less draught, need not be discussed. It is, however, of considerable importance to merchant ships, exercising an appreciable effect upon their freeboard when deeply laden.

The buoyancy of a ship has already been defined, and shown to be measured by the displacement up to any assigned water-line. "Reserve of buoyancy" is a phrase now commonly employed to express the volume, and corresponding buoyancy, of the part of a ship not immersed, but which may be made watertight, and which in most vessels would be inclosed by the upper deck, although in many cases there are watertight inclosures above that deck—such as poops, forecastles, breastworks, &c. The under-water, or immersed, part of a ship contributes the buoyancy; the out-of-water part the reserve of buoyancy, and the ratio between the two has a most important influence upon the safety of the ship against foundering at sea. The sum of the two, in short, expresses the total "floating power" of the vessel, and the ratio of the part which is utilised to that in reserve is a matter requiring the most careful attention. This fact has come into prominence recently in the discussion of questions of lading and freeboard, as affecting the safety of merchant ships.

In Figs. 4-9 are given illustrations of the very various ratios which the reserve of buoyancy bears to the volume of displacement in different classes of ships. As this is only a matter of ratio, a box-shaped form has been employed instead of a ship-shaped, and in all the cases the volume of displacement is the same, so that the out-of-water portions can be compared with one another as well as with the displacement.

Fig. 4 represents the condition of low-freeboard American monitors, such as the *Canonicus* or *Passaic*, which were employed on the Atlantic coast during the Civil War. The upper decks of these vessels are said to have been between 1 and 2 feet only above water; their reserve of buoyancy was only 10 per cent. of the displacement.

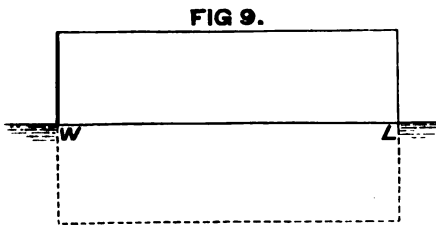
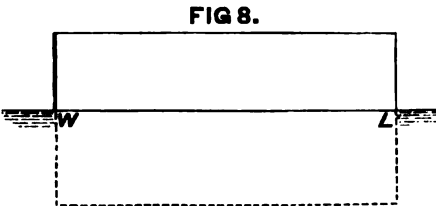
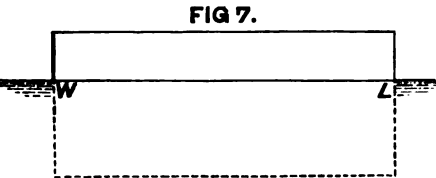
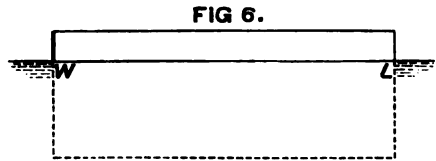
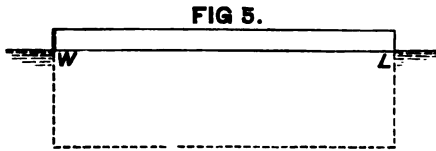
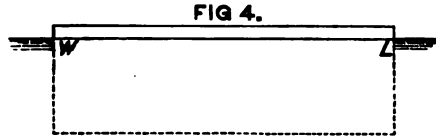
Fig. 5 represents the condition of the American monitor *Miantonomoh*, with a reserve of buoyancy of about 20 per

cent. of the displacement; this approximately shows her state when she crossed the Atlantic in 1866, but all openings on her upper deck, which was about 3 feet above water, were carefully closed or caulked.

Fig. 6 represents the *Cyclops* class of breastwork monitors in the Royal Navy. The upper decks of these vessels are only about the same height above water as that of the *Miantonomoh*, but, by means of an armoured breastwork standing upon the upper deck, the reserve of buoyancy is increased to 30 per cent. of the displacement.

Fig. 7 represents the *Devastation* class, in which the reserve of buoyancy is 50 per cent. of the displacement.

Fig. 8 represents armoured frigates of high freeboard



—such as the *Sultan* or *Hercules*—of the Royal Navy, in which the reserve of buoyancy reaches 80 or even 90 per cent. of the displacement.

Fig. 9 represents ships of high freeboard and fine underwater form—typified by her Majesty's ship *Inconstant*—in which the reserve of buoyancy is equal to, or even greater than, the displacement.

So much for vessels of war. As regards merchant ships, the diversity of practice in loading renders it difficult to lay down any rule; there seems, however, a concurrence of opinion in fixing the minimum reserve of buoyancy at from 20 to 30 per cent. of the displacement, varying it according to the season of the year, the character of the cargo, extent of the voyage, &c. But, perhaps, the greatest difficulty met with in attempting to apply any such rule to merchant ships is found in the selection of those parts of the ships which shall be regarded as contributing to the reserve of buoyancy. "Spar-decks," "deck-houses," "inclosed poops and fore-castles," &c. are very commonly built, of comparatively slight scantlings, above the upper deck proper; and the assignment of proper values to these erections in estimating the reserve of buoyancy has given rise to much discussion, out of which no practical rule for guidance has come which can command general acceptance.

Submarine vessels, such as have been built or proposed for use in war, furnish examples differing from ordinary ships. They are intended at times to be wholly submerged, and then have no "reserve of buoyancy," using that term in the same sense as above. Such vessels, of course, require to be arranged so that the operators within them may control the vertical motions, either rising to the surface when necessary or submerging the vessel to any desired depth. For all practical purposes, water may be treated as if it were incompressible; at any depth in which submarine vessels would work, a cubic foot of sea-water may be taken as weighing 64 lbs. The weight of a vessel and all its contents may also be assumed to be practically a constant

quantity during the period of one submersion, and, as already explained, the displacement of the vessel, when it floats at rest at any depth, must always equal the weight. To produce vertical motions in such a vessel, it is therefore necessary to give the operator the power of *slightly varying the displacement*. If he can virtually decrease the volume of displacement, below that corresponding to the total weight, the vessel must sink; but if, when the desired depth is reached, he can gradually restore the displacement to equality with the weight, no further sinking will take place, nor will the vessel have any tendency to rise. Before she can rise, the volume of water displaced must by some means be made to exceed that corresponding to the weight; directly that condition is fulfilled, the vessel begins to rise. A very simple arrangement suffices to give the operator the necessary control. For instance, conceive that a small cavity is formed in the bottom of the vessel, and that, when this cavity is about *half full* of water, the total displacement of the vessel, when entirely submerged, just corresponds to the total weight. The other half of the cavity may be then kept filled with compressed air, which is in communication with an air chamber in the interior of the vessel. The air in the air chamber would be compressed sufficiently to have a considerable excess of pressure over that corresponding to the maximum depth of immersion at which the vessel is to be employed. When the compressed air is withdrawn from the upper half of the cavity, by an apparatus worked within the vessel, the water rises into the vacated space, the volume of displacement becomes decreased by that space, and is therefore less than will balance the weight; as a result, the vessel sinks. The desired depth being reached, compressed air stored within the vessel may be made use of to force the water once more from the upper half of the cavity, thus restoring equality between the weight and displacement; the vessel then remains at that depth. Lastly, when it is required to rise, by means of compressed air the water is wholly expelled from the cavity; the

displacement then exceeds the weight, and consequently the vessel rises. Other agencies may be employed to effect these results; but the principle is the same for all—the operator must have the power of virtually increasing or decreasing the volume of displacement.

Ships founder when the entry of water into the interior causes a serious and fatal loss of floating power. There are two cases requiring notice. The first, and less common, where the bottom of the ship remains intact, but the sea breaks over and “swamps” the vessel. The second, that in which the bottom is damaged or fractured, and water can enter the interior, remaining in free communication with the water outside. Damage to the under-water portion of the skins of ships is by far the most fruitful source of disaster; but many ships founder in consequence of being swamped, seas breaking over them, and finding a passage down through the hatchways into the hold.

The older sailing brigs of the Royal Navy are believed by many competent authorities to have been specially exposed to this danger. Very many of them were lost at sea; and their loss was believed to have resulted from the lowness of their freeboard, the height of their bulwarks, and the insufficiency of the “freeing scuttles” in the topsides to clear rapidly the large masses of water which lodged on the decks. In consequence, water accumulated, passed into the interior, and swamped the ships. The case of the steam-ship *London* furnishes another illustration. She is said to have been lost in consequence of a very heavy sea having swept away the covering of the engine hatchway, and left open a large aperture, down through which the water poured, putting out the fires, and leaving the ship a log on the water. Other seas washing over the unfortunate vessel completed the disaster, and she gradually sank. The United States monitor *Weehawken* also appears to have been lost in this manner. While forming part of the blockading squadron, and lying at anchor off Charleston with her hatchway forward uncovered, the weather being compara-

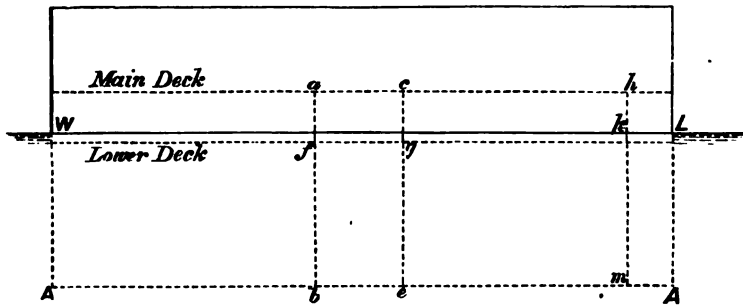
tively fine, a sea broke on the deck, poured down the open hatchway, and caused the vessel to sink rapidly—it is said in three minutes—her extreme lowness of freeboard and small reserve of buoyancy conducing to this end. Still another, and slightly different, case in point may be found amongst the vessels engaged in the timber trade. It has been customary to load these ships very deeply, and often to carry large deck cargoes; thus interfering with the efficient working of the ships. Meeting with heavy weather, and being only partially under control on account of the deck cargoes, these vessels frequently ship large quantities of water, becoming “water-logged,” and utterly unmanageable, even if they do not sink.

The condition of a water-logged ship naturally leads to the remark, that in any ship of which the outer skin remains intact, the maximum quantity of water that can enter the interior may or may not suffice to sink her, according as it is greater or less in weight than the reserve of buoyancy which the ship possesses. The maximum quantity of water that can enter the interior is determined by the *unoccupied space*: for to space which is already occupied by any substances—cargo, coals, engines, &c.—the water can obviously find no access. If the cargo be, like timber, very light, occupying a very large portion of the internal space, then it may happen that the total volume of the space unoccupied is less than that of the reserve of buoyancy, and the ship remains afloat; but this is not the common case, and if a vessel becomes swamped, and the sea finds access into all parts of the interior through the hatchways, she will most probably founder. Properly constructed and well-laden vessels are not, however, likely to founder in this fashion. Their hatchways and openings in the decks are carefully secured, and protected by high coamings and covers; while the interior is so subdivided into compartments, especially in iron ships, that, if a sea breaks on board, and finds its way down a hatch, it does not gain free access from the space thus entered to all other parts of the interior. Any amount

of free water, however, which passes thus into a ship must considerably affect her behaviour in a sea-way. Hereafter the matter will be considered more fully, and for the present it will suffice to say that, when a ship is rolling, the wash of water in her hold from side to side may so increase the amplitude of her oscillations as to jeopardise her safety, making her liable either to capsize, to labour heavily and ship more water, or to sustain other injuries.

Turning next to the case of the ship of which the skin is penetrated below water, it is needless to cite examples of the possibly serious nature of such an accident. Very many illustrations will at once occur to the mind of every

FIG 10.

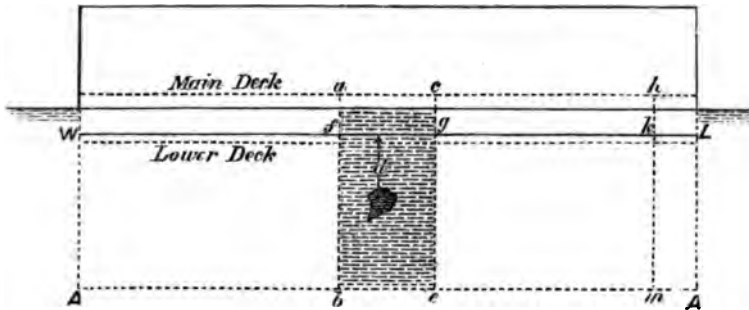


reader; this being a very common source of loss now that iron is the material generally used in building merchant ships. The causes of the under-water damage may be various—such as accidental collision, local wear and tear, grounding, ramming, torpedo explosions, &c.—but in all cases water can enter the ship, and this water remains in *free* communication with the water outside. So long as that communication is maintained, water will continue to pass into the ship until either it can find access to no further space or has entered in such quantities as to exceed the reserve of buoyancy, when the vessel sinks.

A simple illustration will render these statements clear. Take a box-shaped vessel, such as in Figs. 10 and 11, and

suppose a hole to be broken through the skin under water. The water at once passes into the interior in quantities depending upon the area of the hole and the depth it is below the water-level. A very simple rule expresses the initial rate of inflow.

FIG 11.



Let A = area of the hole (in square feet).

„ d = the depth below water in feet (taken about the centre of the hole will be near enough for practical purposes).

Then, if v = velocity of inflow of the water in feet per second,

$$v^2 = 64 d \text{ (approximately); and } v = 8 \sqrt{d};$$

so that, immediately after an accident, the volume of water passing into the vessel in each second

$$= 8 \sqrt{d} \times A \text{ (cubic feet).}$$

Suppose, for example, the hole is 2 square feet in area, and has its centre 12 feet under water :

$$v = 8 \sqrt{12} = 27\frac{3}{4} \text{ feet per second.}$$

$$\text{Water flowing in per second} = 27\frac{3}{4} \times 2 = 55\frac{1}{2} \text{ cubic feet.}$$

If the vessel floats in sea-water,

$$\text{Tons of water flowing in per second} = 55\frac{1}{2} \div 35 = 1.58.$$

Similarly, for any other depth or area of hole in the

bottom of a ship, this rule will enable the rate of inflow to be determined very nearly.

Reverting to Fig. 10, it is obvious that, if the water can find free access to every part of the interior—which would be true if there were no partitions forming watertight compartments—the ship must sink: unless the power of her pumps is sufficient to overcome the leak; or some means is devised for checking the inflow, by employing a sail, or a mat, or some other “leak-stopper”; or the total unoccupied space in the interior is less than the reserve of buoyancy, a condition not commonly fulfilled. Very little reflection will show that it is hopeless to look alone to the pumps to overcome leaks that may be caused by collision, ram attacks, or torpedo explosions; the area of the holes broken in the skin admitting quantities of water far too large to be thus dealt with. Hence attention is directed to two other means of safety: the first, minute watertight subdivision of the interior of the ship, to limit the space to which water can find access; the second, the employment of leak-stoppers, which can be hauled over the damaged part, and made to stop or greatly reduce the rate of inflow. This latter is a very old remedy, Captain Cook having used a sail as a leak-stopper during his voyages, and many ships having been saved by similar means. It has acquired renewed importance of late, and various inventors have proposed modifications of the original plan, but all these are based upon the old principle of “stopping” the leak. Such devices are not embodied in the structure or design of the ship, but form simply part of her equipment; whereas watertight subdivision is a prominent feature in the structure of a properly constructed modern iron ship. It will be well, therefore, to sketch some of its leading principles. In doing so, we shall, for the sake of simplicity, make use of box-shaped vessels for purposes of illustration; but the conclusions arrived at will, in principle, be equally applicable to less simple forms, like those of ships.

There are three main systems of watertight subdivision: (1) by vertical athwartship bulkheads; (2) by longitudinal bulkheads; (3) by horizontal decks or platforms. Besides these there is the very important feature of construction known as the "double bottom," the uses of which will be described further on. In Figs. 10 and 11 the hole in the skin, admitting water to the hold, is supposed to lie between two transverse bulkheads (marked ab and ce) which cross the ship and form watertight partitions rising to some height above the load-draught line (WL) and terminating at a deck marked "Main Deck." The great use of these bulkheads will be seen if attention is turned to Fig. 11, which represents the condition of the box-shaped vessel after her side has been broken through. The vessel has sunk deeper in the water than when her side was intact; and it is easy to determine what the increase in draught has been when one knows the volume ($fgeb$, in Fig. 10) of the damaged compartment, as well as the volume in that space which is occupied by cargo, or machinery, or other substances. To simplify matters, suppose this compartment to be empty; and assume the length ac to be one-seventh of the total length AA : then the volume $fgeb$ will be about one-seventh of the total displacement; and when this compartment is bilged and filled with water up to the height of the original water-line WL, one-seventh of the original buoyancy will be lost. In fact, the compartment between the bulkheads no longer *displaces* water; in it the water-level will stand at the height of the surface of the surrounding water; and since the weight of the ship remains constant, the lost buoyancy must be supplied by the parts of the ship lying before and abaft the damaged compartment. For this reason we must have—

$$\begin{aligned}
 & \frac{1}{7} \text{ original water-line area} \times \text{increase in draught} \\
 & = \frac{1}{7} \times \text{displacement} \\
 & = \frac{1}{7} \times \text{original water-line area} \times \text{original draught.} \\
 & \text{Increase in draught} = \frac{1}{7} \text{ original draught.}
 \end{aligned}$$

This very simple example has been worked out in detail because it illustrates the general case for ship-shape forms. The steps in any case are:—

(1) The estimate of loss of buoyancy due to water entering a compartment; this loss being equal to the part of the original displacement which the damaged compartment contributed, less the volume in the compartment occupied by cargo, &c.

(2) The estimate of the increased draught which would enable the still buoyant portions of the vessel to restore the lost buoyancy if the entry of water were confined to the damaged compartment.

And to these, in practice, must be added—

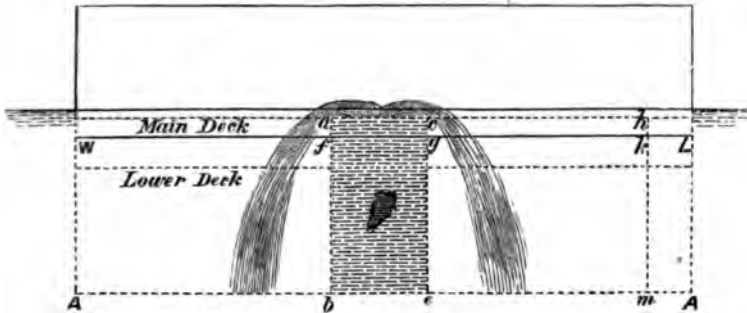
(3) The change of trim (if any) resulting from filling the damaged compartment.

Reverting to Figs. 10 and 11, it will be obvious that, if the transverse bulkheads *ab* and *ce* did not rise above the original water-line WL, more than one-sixth of the original draught, they would be useless as watertight partitions; because, when the compartment was bilged, their tops would be under water before the increase of draught had sufficed to restore the lost buoyancy. And when their tops are under water (unless the deck at which the bulkheads end forms a watertight cover to the compartment), the water is free to pass over the tops, or through hatchways and openings in the deck, into the adjacent compartments, thus depriving them also of buoyancy, and reducing the ship to a condition but little better than if she had no watertight partitions in the hold. Fig. 12 illustrates this serious defect. The main deck at which the transverse bulkheads *ab* and *ce* end is lower than in Figs. 10 and 11, all other conditions remaining unchanged; and consequently, when the compartment is bilged, the water can pour over the tops of the bulkheads into the spaces before and abaft.

Hence this practical deduction. Watertight transverse bulkheads can only be efficient safeguards against foundering when care is taken to proportion the heights of their tops

above the normal load-line to the volumes of the compartments; or else to make special provisions for preventing water from passing into adjacent compartments by means of watertight plating on the decks at which the bulkheads end, in association with watertight covers or casings to all hatchways and openings in the decks. Unfortunately, in iron merchant ships, anything approaching to efficient subdivision by transverse bulkheads is commonly, wanting; and in some cases, where the number of the compartments has been sufficiently great to secure a fair degree of safety, the heights to which the bulkheads have been carried have

FIG 12.

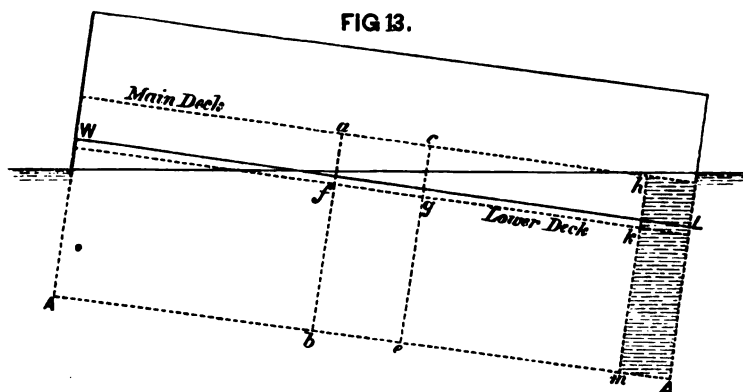


not been sufficient to ensure efficiency when the vessels were fully laden.

A vessel would ordinarily be considered well subdivided if she would keep afloat with any *two* compartments filled simultaneously. This was the recommendation of the council of the Institution of Naval Architects in 1867; but in the vessels of the Royal Navy it is not unusual to find the subdivision so minute that from three to six of the largest compartments may be simultaneously filled, without bringing the tops of the bulkheads under water, or allowing water to pass into compartments adjacent to those filled.

The midship compartments of a ship are usually the largest, and claim most attention; but those near the extremities are also important, because, although their

volume may be small, when they are filled they cause a considerable *change of trim*. Reverting once more to our box-shaped vessel in Fig. 10, instead of supposing an empty midship compartment equal to one-seventh of the length to be filled, and to cause a loss of one-seventh of the buoyancy, let it be supposed that a compartment only half as long and half as large at one end (shown by $mkLA$ in the diagram) is filled. The increase in the mean draught due to this accident would be only one-thirteenth of the original draught, but the trim would be altered very considerably (as shown in Fig. 13); and the top of the bulkhead hkm , although as high as those amidships, would be put under water by the



change of trim. Consequently, unless the main deck is made watertight as far aft as the bulkhead hm , this very small compartment forward might, from its influence on the trim, be large enough to sink the ship; for when it is filled, if the deck does not form a watertight top to it, the water will pass over (at h) into the next compartment, the bow will gradually settle deeper and deeper, and at last the vessel will go down by the head. It will be in the recollection of many readers that ships which founder very commonly settle down finally either by the head or the stern, and the foregoing simple illustration will furnish an explanation of some such occurrences.

It should be added that the assumptions made in the box-shaped vessel are fairly representative of actual ships. For example, in her Majesty's ship *Devastation*, if one of the large compartments amidships were filled, the ship would have an increased draught of about 15 or 16 inches, and her trim would be practically unaltered. If the aftermost compartments were filled, so as to give the ship an increase of 7 or 8 inches in the mean draught, the trim would be changed from $4\frac{1}{2}$ to 5 feet, and the tops of the bulkheads bounding these extreme compartments would be put under water. No evil would result, however, for these bulkheads are ended at a watertight iron deck.

Passing from transverse to longitudinal bulkheads, the same principles apply. The heights to which the bulkheads are carried should be carefully proportioned to the sizes of the compartments of which the bulkheads form boundaries; and watertight decks are no less useful as tops to such compartments when the bulkheads cannot be carried high enough to secure the restoration of the lost buoyancy. In this case, however, the longitudinal partitions, supposing only one side of the ship to be damaged, destroy the symmetry of the true "displacement," and the result is that the vessel heels over towards the damaged side. Transverse inclination takes place without change of trim if the damaged compartment is amidships; but if it be near the bow or stern, both change of trim and transverse inclination will result from the same accident. It is needless to do more than deal with the latter, as the influence of change of trim has already been described; and in this case the box-shaped vessel will once more furnish a simple illustration of what may happen in ships.

In Fig. 14, suppose the large midship compartment bounded by transverse bulkheads, *ab* and *ce* (in profile view), to be subdivided by longitudinal bulkheads, *pq*, *rs* (in section); in the positions shown, these longitudinal bulkheads fairly represent the coal-bunker bulkheads of an iron-clad, being rather less than one-fourth of the breadth of the

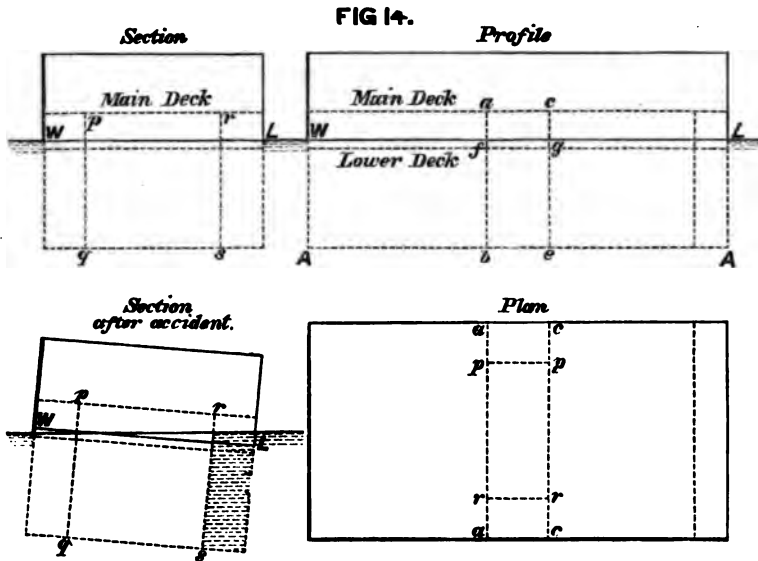
ship within the side. The "wing compartment" lying outside the bulkhead, marked *rs* in section, and *rr* in plan, Fig. 14, may be supposed to contain three-sixteenths of the total volume of the compartment between the transverse bulkheads *ab* and *ce*; reckoning up to the load-line *W L*, this will give,

$$\left. \begin{array}{l} \text{Loss of buoyancy when wing} \\ \text{compartment is filled} \\ \text{with water} \end{array} \right\} = \frac{3}{16} \times \frac{1}{2} \text{ total displacement.}$$

$$= \frac{3}{112} \text{ total displacement.}$$

$$\text{Increase in mean draught} = \frac{3}{112} \text{ original draught.}$$

But this will be accompanied by a heel towards the damaged side, as indicated in the lower section (Fig. 14),

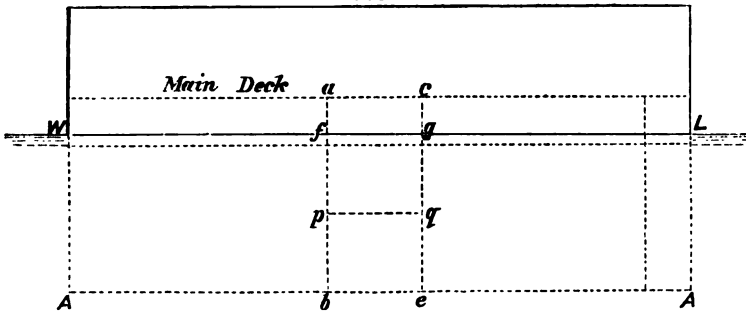


amounting, in the example chosen, to the immersion of the damaged side to about four times the extent of the increased mean draught due to loss of buoyancy. Hence it is clear that, in arranging longitudinal bulkheads, care must be taken either to carry them high enough to provide against

heeling or else to have watertight plating forming a top to the compartments.

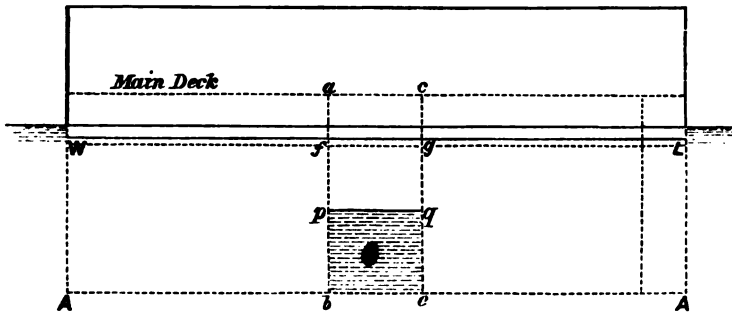
Lastly, attention must be directed to the usefulness of horizontal watertight decks or platforms in preventing loss of buoyancy. It is unnecessary to repeat what has been said

FIG. 15.



respecting decks lying above the normal load-draught line, and forming tops to spaces inclosed by longitudinal or transverse bulkheads; consequently attention will be confined to

FIG. 16.



the cases where a deck or platform lies below the load-line. In such cases either one of two accidents may be assumed to have happened: viz. the side has been broken through *below* the platform, or else *above* it. Turning to Fig. 15, let it be supposed that the large midship compartment bounded by the transverse bulkheads *ab* and *ce* has a

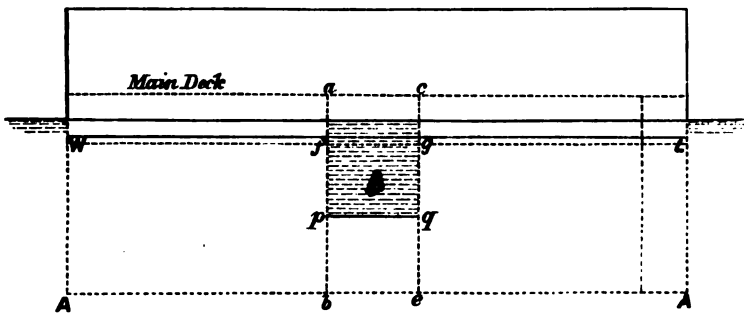
watertight platform pq worked in it, at mid-draught. The volume of this compartment up to the load-line being *one-seventh* of the displacement, the buoyancy contributed by either of the parts into which it is divided by the platform will be one-fourteenth the displacement. If the side is broken through below the platform, the whole of the water-line area WL contributes buoyancy when the vessel is immersed more deeply; therefore, if the whole space is considered accessible to water (as shown in Fig. 16)—

Increase in mean draught due to }
 bilging compartment below pq } = $\frac{1}{4}$ original draught.

But if the side is broken through above the platform, only $\frac{2}{3}$ the water-line area contributes buoyancy; therefore (as shown in Fig. 17)—

Increase in mean draught due to }
 bilging compartment above pq } = $\frac{1}{2}$ original draught.

FIG 17.



This contrast shows how important a thing it is to take all possible measures to maintain the buoyancy of the ship at the load-line; for any decrease of that buoyancy not merely affects the draught of water, but also decreases the stability of a ship, as will be shown hereafter. It may be added that, in all cases where openings have to be made in a watertight deck or platform, either watertight covers must be

fitted to the openings or watertight trunks, carried to a sufficient height above the load-line, must be built around them.

All the methods of watertight subdivision illustrated above are associated in well-built ships; and the minuteness of subdivision attained when care is taken is well exemplified in Figs. 18-25, which represent the arrangements of the watertight partitions in a modern ironclad of the Royal Navy. Such vessels have the great safeguard of a "double bottom," formed by a watertight inner skin fitted some distance within the outer skin. This inner skin extends from two-thirds to three-fourths of the total length of the ship; its terminations are marked *c, c* in the profile view (Fig. 18) and the "plan of double bottom" (Fig. 20). From the keel up to the turn of the bilge, the inner skin is worked about 3 or 4 feet within the outer; as shown in the sections (Figs. 21-25), from the points *a* downwards. At *a* there is a watertight longitudinal partition (or frame), and the keel is also made watertight. Above the turn of the bilge, the inner skin (*w, w* in the sections) is usually worked vertically up to the height of the main deck, thus inclosing "wing-spaces" in the region of the water-line, or, as it is termed, "between wind and water." The inner skin is here often 8 or 10 feet within the outer. In addition to the longitudinal partitions at the bilges (*a*, in sections) and at the keel, the double bottom is subdivided by numerous watertight transverse partitions (shown by *f, f* in Fig. 20), about 20 feet apart; compartments, of very moderate size, being thus formed between the two skins.

Within the limits of the double bottom, the hold-space is subdivided by means of transverse bulkheads (*b, b*, Fig. 18), and longitudinal bulkheads (*l, l*, Fig. 19). Before and abaft the double bottom there is only a single skin, and the subdivision is effected by means of transverse bulkheads and horizontal platforms (*p, p*, Fig. 18). Although there is no inner skin at the extremities, the subdivision

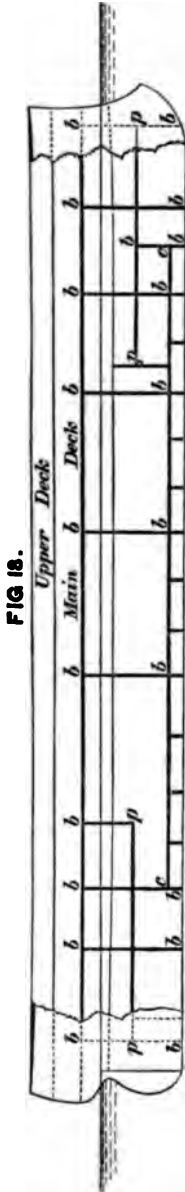


FIG 19.



FIG 20.



there is very minute, and the compartments are small, owing to the fineness of form of the bow and stern. The "plan of hold" in Fig. 19, taken in connection with the profile (Fig. 18), will give a very complete view of the subdivision of the hold-space. Besides the main partitions already alluded to, it will be observed that, in many cases, partitions required primarily for purposes of stowage or convenience are made watertight in order to make the subdivision more minute. Examples will be found in the coal-bunker bulkheads, the chain-lockers (immediately before the boiler-rooms), the magazines and shell-rooms, and the shaft-passages. Slight increase of cost and workmanship, with a very small increase in weight, are thus made to contribute to much greater safety. It need only be added that the principal bulkheads either run up to the main deck, situated some 5 or 6 feet above water, or are ended at a watertight platform.

The spaces occupied by the machinery almost necessarily form large compartments amidships; but in recent ships the stoke-holds have each been divided into two by means of a middle-line bulkhead (*U*, in Fig. 19); and in vessels propelled by twin-screws, as is the case in our example, the engine-room compartment is similarly halved. The great advantages resulting from this middle-line division are too obvious to need comment, especially in ships which are mainly or wholly dependent upon steam power for propulsion.

Very great advances have been made in the minuteness of the watertight subdivision in recent ironclads, and it is now not uncommon to find from sixty to ninety compartments in the hold-space alone, besides thirty or forty compartments in the double bottom.

The *Devastation* may be taken as a good example of a modern war-ship, although she has no middle-line bulkhead in her engine and boiler rooms.* Her double bottom and

* Drawings and full details of the watertight subdivision of this ship, and of other classes of ironclads, will be found in the report of the Committee on Designs for Ships of War in 1871. The following table gives the number of compartments in several of the most

wings are divided into thirty-six compartments; the hold-space into sixty-eight compartments. If the three largest compartments of the hold (viz. the engine and boiler rooms) are filled, the vessel will only be immersed about $3\frac{1}{4}$ feet. If she had a middle-line bulkhead, like the later ships, each of these large compartments would be halved, and it would be most improbable that both halves of any compartment

important ships of the Royal Navy; *Transactions* of the Institution of Naval Architects, it appears in vol. xvii. of the

Ironclad Ships of Royal Navy.		Watertight Compartments.		
Classes.	Names.	In Hold-space.	In Double Bottom and Wings.	Total.
Largest early types	<i>Warrior</i> . . .	35	57	92
	<i>Achilles</i> . . .	40	66	106
	<i>Minotaur</i> . . .	40	49	89
Smaller early types	<i>Hector</i> . . .	41	52	93
	<i>Resistance</i> . . .	47	45	92
Largest recent masted types	<i>Monarch</i> . . .	33	40	73
	<i>Hercules</i> . . .	21	40	61
	<i>Sultan</i> . . .	27	40	67
	<i>Alexandra</i> . . .	41	74	115
	<i>Temeraire</i> . . .	44	40	84
Smaller masted types	<i>Vanguard</i> . . .	23	40	63
	<i>Triumph</i> . . .	26	40	66
Belted ships	<i>Shannon</i> . . .	44	32	76
	<i>Nelson</i> . . .	83	16	99
Mastless or lightly rigged	<i>Devastation</i> . . .	68	36	104
	<i>Dreadnought</i> . . .	61	40	101
	<i>Inflexible</i> . . .	89	46	135
Rams	<i>Hotspur</i> . . .	26	32	58
	<i>Rupert</i> . . .	40	40	80
Monitors	<i>Gorgon</i> . . .	19	20	39
	<i>Glatton</i> . . .	37	60	97

would be filled simultaneously. The total number of compartments in the hold would then be seventy-one, and filling any six compartments amidships would immerse the vessel as before. The largest compartment in the double bottom holds only about 50 tons of water, corresponding to an increased immersion of only $1\frac{1}{2}$ inch; and the whole double-bottom space will carry 1000 tons of water ballast, the additional immersion being 28 inches.

The lower part of any ship is most liable to injury by touching the ground, the thin bottoms of iron ships being peculiarly liable to serious damage. If there be an inner skin, however, and the damage does not extend to it, fracture of the outer skin may be very extensive, but no water will enter the hold. Very many cases are on record, showing the great usefulness of the inner skin; two only will be mentioned. The first is that of the *Great Eastern*, which has a complete double bottom. Off the American coast the vessel ran ashore, and tore a hole 80 feet long in her outer skin, but the inner skin remained intact, and no water entered the hold. The second is that of her Majesty's ship *Agincourt*, which ran on the Pearl Rock at Gibraltar; this ship has a partial double bottom, and fortunately grounded at a part where the inner skin existed, so that no serious consequences followed.

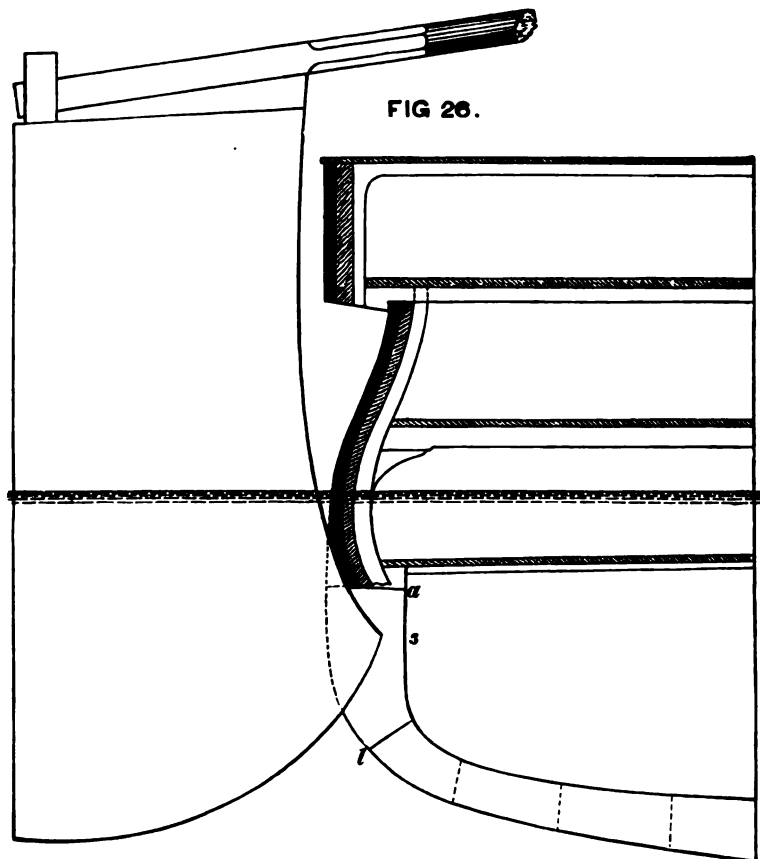
The double bottom from the bilges down is also very useful as a space for water ballast. Great advantage results from the arrangement, especially in merchant ships, the delays and expenses consequent on the use of rubble ballast being avoided; partial double bottoms, or water ballast tanks, are now frequently fitted.

The parts of the inner bottom situated above the bilges (see sections in Figs. 21-25) are often termed "wing-passage bulkheads," and are so far inside the outer skin that the chances of their being broken through are much lessened. In a war-ship it is at this part that the greatest damage is likely to be done by ramming or torpedo explosions; and the best known remedy against either is undoubtedly

internal subdivision. To attempt to keep out either a ram or a torpedo attack is hopeless; the outer skin is certain to be broken through, and possibly the inner also. But whereas a grazing blow at low speed would suffice to tear a large hole in the outer skin, only the direct blow of a ram moving at good speed would be likely to penetrate the inner skin of an armoured ship.

An illustration of the usefulness of the wing-passage bulkhead against ramming or collision was afforded in the accidental collision of the *Minotaur* and *Bellerophon*; the outer skin of the *Bellerophon* was broken, and the armour driven in, but the ship remained on service for some time before the repairs were completed. Again, when the *Hercules* and *Northumberland* came into collision, a very similar advantage resulted from the existence of the wing-passage in the latter ship. In the case of the *Vanguard*, although the vessel was lost, the existence of the inner skin was an immense advantage to the ship, keeping her afloat for seventy minutes after the collision, whereas, had there been no inner skin, the vessel must have sunk in a very few minutes. So much misapprehension has existed on this matter that it may be well to adduce a few facts in support of the foregoing statement. Fig. 26 shows a cross-section of the *Vanguard*, with the bow of the *Iron Duke* in the position which it probably occupied at the time of the collision. It will be noted that, although the armour was driven in, and the armour shelf (*a*) damaged, the inner skin (*s*) was not pierced. This the divers asserted after careful examination, and there is conclusive corroborative evidence that their report is correct. Evidence given before the court-martial proves that at first the vessel sank at the rate of only 8 inches in fifteen minutes, and at last at the rate of one inch per minute; this maximum rate of sinking corresponds to a total inflow of only 27 tons of water per minute, which would have been admitted by an aperture less than *one square foot in area*. But the divers, after measurement, reported that the hole in the outer

skin was 10 feet in depth, varying in breadth from 2 feet to 3 feet. Assuming the area to have been 20 square feet (which is probably less than the truth), the initial rate of inflow of water per minute, had there been no inner skin,



would probably have been at least 1000 tons, or nearly fortyfold what it actually was at the last. It seems certain, therefore, that the damage to the armour shelf, and other parts of the ship, admitted into the hold in the aggregate

no more water than a hole one square foot in area in the skin of an ordinary ship with no double bottom would have admitted, notwithstanding the fact that the *Iron Duke* struck the *Vanguard* a blow much exceeding in force that delivered by the projectile of a 35-ton gun at the muzzle. It is noteworthy also (see Fig. 26, and the sections in Figs. 21-25) that in the *Vanguard* the inner skin terminated about 4 feet under water, whereas in most of her Majesty's ships it is carried to the main deck, several feet above water—a preferable arrangement. Even her loss supplies, therefore, a most striking example of the utility of watertight subdivision, for she was kept afloat more than an hour by this means, instead of foundering in a very few minutes, as an ordinary iron ship similarly damaged in the outer skin must have done. It would be out of place here to further discuss the circumstances attending the disaster, but it may be observed that they illustrate the necessity for taking all possible care in maintaining the integrity of bulkheads and other partitions intended to be watertight, as well as for keeping in thorough working order the doors or covers fitted to any apertures cut in bulkheads or platforms for ventilation or for convenient access to compartments in the hold.

In the preceding pages considerable use has been made of the "reserve of buoyancy" as a measure of the comparative safety of ships; and this measure very generally commends itself to naval architects as a substitute for linear measurement in statements of the "freeboard" of ships. Freeboard, in its common use, means the height of the upper deck amidships (at the side) above water, and is stated in feet and inches; but this must necessarily be associated in some way with the size of the ship. The old rule for freeboard, commonly known as "Lloyd's rule," was based upon the "depth in hold" of ships, and may therefore be taken as having roughly proportioned the relative volumes of the in-water and out-of-water parts of a ship when floating in still water. The rule was:—

Freeboard = from 2 to 3 inches per foot depth in hold.

In 1867 the council of the Institution of Naval Architects took up this question, proposing to make the freeboard of ships mainly dependent on the beam. Their rule was as follows:—

Freeboard (in feet) = one-eighth the beam, with the addition of one-thirty-second part of the beam, for every beam in the length of the ship, above five beams.

For example, a ship 160 feet long, and 32 feet beam, is *five beams* in length; freeboard = $\frac{1}{8} \times 32 = 4$ feet. If she were 192 feet in length, or *six beams* (one beam in excess of the five): freeboard = $\frac{1}{8} \times 32 + \frac{1}{32} \times 32 = 5$ feet. If she were 224 feet long, or seven beams: freeboard = $\frac{1}{8} \times 32 + \frac{2}{32} \times 32 = 6$ feet. And so on.

This rule obviously fails by the omission of any reference to the *depth* of the ship; deep, narrow ships, which would require exceptional freeboard in consequence of their bad proportions, would by this rule gain upon better-proportioned vessels, and have a relatively low freeboard granted to them. Moreover, in the very long vessels now commonly employed, say with a length *ten* times the beam, the allowance for the additional *five* beams would be proportionately very great—in fact, the freeboard required by the rule might be excessive. On the whole, therefore, in spite of the authority on which the proposed rule rests, it is not surprising that it has never come into general use.

In connection with the recent legislation for the safety of merchant shipping, and the inquiry of the Royal Commission upon which that legislation has been based, the question of freeboard, with its closely allied topic—load-draught—has been much discussed. After taking the evidence of many professional men, the commission came to the conclusion that no general rule for freeboard and draught could, with advantage, be laid down. Consequently the law now fixes no minimum of freeboard, but requires the shipowner to mark upon the sides of the ship the maximum draught

which he proposes not to exceed in loading her for any voyage. The decision as to ships being overladen or not now rests with surveyors appointed by the Board of Trade. These surveyors have the power of detaining ships considered to be overladen; and their decision is subject to revision by local courts of survey.

In ships of war the freeboard is usually governed by considerations of the height at which guns should be carried to be fought efficiently, rather than by considerations of safety from foundering. These considerations of fighting efficiency generally involve the adoption of a height of freeboard much in excess of what would be considered necessary in merchant ships. Even in the breastwork monitors, with their upper decks some 3 or $3\frac{1}{2}$ feet above water, the reserve of buoyancy, augmented as it is by the breastwork which stands upon the upper deck, is about equal to that which good authorities fix for the average reserve in merchant vessels fairly laden.

Hereafter it will be shown that the height of freeboard also exercises an important influence in preventing ships from being easily capsized by the action of the winds and waves.

CHAPTER II.

THE TONNAGE OF SHIPS.

AT a very early period the necessity must have been felt for some mode of measuring the sizes of ships either for purposes of comparison, or for estimating the cost of construction, or for computing the various dues and duties from time immemorial levied upon shipping. In some ancient documents statements occur of the "tonnage" or "portage" of ships; but it is not possible to settle how this tonnage was calculated. There is reason to believe that it was based upon some rough approximation to the number of butts or *tuns* of wine which a vessel could carry; and that from this custom the term "tonnage" was derived.* The number of butts of wine that could be carried in a ship of course depended upon her internal capacity; and in all probability this number was at first determined by actual stowage of the hold. Eventually there must have arisen a desire to arrange some method of calculation giving a fair approximation to the carrying power of the ship in terms of her principal dimensions—length, breadth, and depth—and avoiding the necessity for stowing the hold. When such an empirical formula had been devised and well tested, it would doubtless work satisfactorily so long as the types of ships, their forms, proportions, and methods of con-

* Much of the information given in this chapter has been published in *Naval Science*, in an article on the "Measurement of Ships," contributed by the Author.

struction, remained unchanged. But any such rule, resting upon no scientific basis, might possibly be evaded by various devices, and in course of time might become an evil which could no longer be borne with.

This was undoubtedly true of the oldest law for tonnage to which reference will be made, the so-called "builders' old measurement," or "B.O.M.," of which the use can be traced back for centuries, and which remained in force until 1836 as the basis for all dues on British shipping. Although then abolished, and replaced by another tonnage law, this older rule continues in use, with some modifications, up to the present time; its imperfections being condoned probably on account of its great age. Until 1872, the B.O.M. tonnage was the only one given in the Navy List for her Majesty's ships; but since then the displacement, as well as the B.O.M. tonnage, has been given. In the United States Navy List the old tonnage measurement, modified in some cases, is still retained. Yachts are also usually measured by a rule which is a slight modification of the B.O.M. rule. And yet it is a generally acknowledged fact that such great injury to the mercantile marine was done by this rule as to justify the repeal of the law that enforced it no less than forty years ago.

From 1836 to 1854 another law was in force for British merchant ships; but no account of this is needed, as it gave place at the latter date to the present law, which introduced "register tonnage"; a mode of measuring ships which has since been adopted by the greatest maritime powers, has been made the basis of charge for passing through the Suez Canal, and will probably be universally adopted before many years have passed. This fact alone is sufficient evidence of the fairness and superiority of the latest tonnage law; it is not absolutely free from objections, as applied to steam-ships, but these are not of great importance when compared with the general scope and working of the measure.

Still another unit of measurement is in common use, viz.

the "freight-ton" or unit of "measurement cargo" for a given ship. This is a purely arbitrary measure, but it has a definite meaning, and is of considerable value in the stowage of ships.

It appears, therefore, that there are in common use the following tonnage measurements :—

- (1) Displacement.
- (2) Builders' old measurement.
- (3) Yacht measurement.
- (4) Register tonnage.
- (5) Freight tonnage.

It is not to be wondered at that some confusion exists as to the exact meaning of the term "tonnage," seeing it is used in so many senses, sometimes expressing weight, at others capacity, and at others a purely arbitrary function of the principal dimensions. In the following pages a brief description of these different tonnages will be given.

Respecting "displacement tonnage," it will suffice to say that it expresses the total weight of a ship (in tons) when immersed to her maximum draught, or "load-line." In the previous chapter allusion has been made to the process by which the naval architect from the drawings of a ship can estimate her displacement. This is a measurement especially suited for war-ships, which are designed to carry certain maximum weights, and to float at certain load-lines, that are fixed with reference to desired conditions, such as height of the guns above water, or limitations of draught imposed by the character of the service. Hence the displacement tonnage furnishes the fairest means of comparison between different types of war-ships; and it has long been in use in the navies of France, Italy, and other European countries, while it alone now appears in the Navy List for the ships of recent design, and in course of time will doubtless entirely replace builders' old measurement.

Merchant ships, as was shown in the previous chapter,

have not to carry certain fixed weights, nor have they usually a fixed maximum load-line. The very various conditions of cargo stowage to which these ships are liable entirely separate them from war-ships; the decision as to the draught to which they can be safely laden must vary with the character of the cargo, its mode of stowage, the nature of the voyage, and the season of the year. With some cargoes the ships might be safe at a deeper draught than would make them unsafe with other cargoes on board. Hence displacement tonnage would not be so fair a measure for merchant ships as it is for ships of war.

A modification of displacement tonnage has been proposed for merchant ships, and styled "dead-weight measurement." The idea is to express the tonnage of a ship by the number of tons weight of cargo which is or can be carried. Two methods of applying this scheme have been suggested. First, to fix the maximum load-line, calculate the corresponding displacement, and then to estimate the number of tons of *cargo* which she could carry, when floating at that line, in addition to her equipment—coals, stores, machinery, &c. Second, it has been proposed to allow the tonnage to vary according to the number of tons of cargo on board at any time; this being ascertained by means of an officially guaranteed "curve of displacement."* Against the first proposal may be urged the difficulty just referred to of fixing by law the maximum load-line for any merchant ship; the second would make the tonnage of any ship a *varying* quantity, which would be most objectionable. In addition, dead-weight measurement has been objected to by the highest authorities on other than professional grounds. All changes so far made in the tonnage laws have intentionally been framed so as to leave unchanged the nominal aggregate tonnage of the British mercantile marine; but the use of dead-weight measurement would entirely change this aggregate tonnage: and there is no reason for incurring this

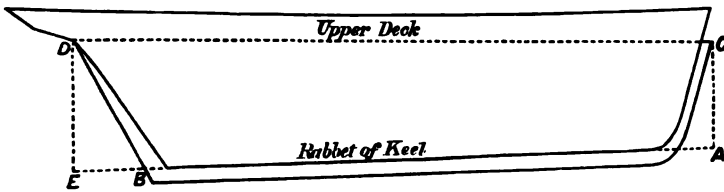
* See page 7 for a description of such curves.

serious practical disadvantage when there are other good grounds for objecting to the methods of measurement which would cause the change. Dead-weight measurement has been strongly supported, and on the first glance appears simple and practical, but it is not likely to supplant register tonnage for merchant ships.

Coming next to builders' old measurement, the rule may be briefly stated as follows:—

(a) The *length* was taken on a straight line along the rabbet of the keel of the ship from the back of the main sternpost to a perpendicular line from the fore part of the main stem, under the bowsprit. Fig. 27 shows this; CA

FIG 27.



is the perpendicular line, and AB is the length required. If the ship was afloat when the measurements for tonnage were made, the length AB could not be taken; and to allow for the rake of the sternpost (BE), and the consequent shortening of the keel, as compared with the length along the deck or water-line, a deduction was permitted of 3 inches for every foot of draught of water from the length measured along the water-line from the perpendicular line AC to the back of the sternpost. Long after raking sternposts ceased to be used in war-ships, a deduction continued to be made for the "rake" of a post which was upright, in order to secure a small diminution of the tonnage.

(b) The *breadth* was taken from the outside of the outside plank in the broadest part of the ship, exclusive of any additional thickness of planking or doubling strakes that might be wrought at that part. This reduction from the extreme breadth to obtain the "breadth for tonnage" amounted to 10

or 11 inches in large vessels, decreasing to 3 or 4 inches in small vessels; it expressed the excess in thickness of the "wales," worked in the neighbourhood of the water-line, over the ordinary bottom planking. In iron ships the breadth extreme and breadth for tonnage are usually identical, except in cases where the armour shelf "overhangs" the hull proper. The *Devastation* is a case in point. Her breadth extreme (to outside of armour) is $62\frac{1}{4}$ feet; the armour and backing (on both sides) project some $4\frac{1}{4}$ feet beyond the hull beneath, and the breadth for tonnage is consequently only 58 feet. In the American monitors, with overhanging armour, similar deductions are made from the extreme breadth in estimating the breadth for tonnage. For example, the *Dictator* had a breadth extreme of 50 feet, and a breadth for tonnage of 41 feet 8 inches.

(c) From the length (obtained as described in (a)) was deducted three-fifths of the breadth for tonnage, the remainder being termed the "length for tonnage." This was multiplied by the breadth, and their product by half the breadth, and dividing by 94, the quotient expressed the tonnage.

In algebraical language, if L = the measured length along the rabbet of keel; B = breadth for tonnage,

$$\begin{aligned} \text{Length for tonnage} &= (L - \frac{3}{5} B); \\ \text{Tonnage B.O.M.} &= \frac{(L - \frac{3}{5} B) \times B \times \frac{B}{2}}{94} \end{aligned}$$

As an example, take a ship for which L = 200 feet, B = 50 feet;

$$\begin{aligned} \text{Tonnage B.O.M.} &= \frac{(200 - \frac{3}{5} \times 50) \times 50 \times \frac{50}{2}}{94} \\ &= \frac{170 \times 50 \times 25}{94} = 2260\frac{50}{94} \text{ tons.} \end{aligned}$$

It will be noted that the continued product in the numerator expresses capacity; the divisor 94 was chosen originally with reference to the carrying power of the ships

upon which this empirical formula was based; but at present no similar meaning attaches to builders' tonnage, and it is quite useless even as a means of comparing ships except they are alike in type.

The following explanation has been given of the probable *rationale* of the B.O.M. rule, and has some interest, although it leaves untouched the foregoing statement. The ratio of length to breadth common in the days of sailing ships was about 4 to 1; the "length for tonnage" was then about seventeen-twentieths of the length of the ship at the water-line. Also the mean draught was about one-half the breadth. Hence (as explained at page 4) it was possible to obtain a good approximation to the total displacement, in terms of the extreme dimensions—length, breadth, and draught; the coefficient of fineness for these extreme dimensions being rather over one-half. That is to say, if L = length at water-line; B = breadth extreme; D = mean draught; displacement (in cubic feet) was a little greater than the product,

$$\frac{1}{2} \times L \times B \times D.$$

Writing L_1 = length for tonnage; then approximately

$$L_1 = \frac{17}{20} L; \text{ and } D = \frac{B}{2}.$$

Displacement (in cubic feet) was therefore a little greater than the product,

$$\frac{1}{2} \times \frac{20}{17} L_1 \times B \times \frac{B}{2},$$

and might be expressed very nearly by

$$\text{Displacement} = \frac{62}{100} \times L_1 \times B \times \frac{B}{2}.$$

Expressing this in weight-units, instead of volume-units,

$$\text{Displacement (in tons)} = \frac{62}{100} \times \frac{L_1 \times B \times \frac{B}{2}}{35}.$$

The hulls of these vessels are said to have absorbed about 40 per cent. of the displacement; so that

$$\begin{aligned} \text{Approximate carrying power (in tons)} \quad \left. \begin{array}{l} \text{in } \{ \\ \text{tons)} \end{array} \right\} &= \frac{3}{5} \times \frac{62}{100} \times \frac{L_1 \times B \times \frac{B}{2}}{35} \\ &= \frac{186}{17500} \times L_1 \times B \times \frac{B}{2} \\ &= \frac{1}{94} \times L_1 \times B \times \frac{B}{2}, \end{aligned}$$

which agrees with the B.O.M. rule.

This is the most reasonable explanation we have met with of the process by which the divisor (94) was obtained; but it will be observed to proceed upon certain fixed proportions of breadth to length, breadth to draught, and weight of hull to displacement; and departures from these proportions rendered the rule useless as a measure of carrying power.

A few examples drawn from the Navy List will serve to show more clearly the inconsistencies and errors involved in applying the old measurement to modern ships; and the reader will find many more examples if he refers to the same publication, where the displacement and B.O.M. tonnage are both given for most of the ships.

Ships.	Displacement.	B.O.M.
{ <i>Warrior</i>	9,137	6,109
{ <i>Devastation</i>	9,190	4,407
{ <i>Minotaur</i>	10,627	6,621
{ <i>Dreadnought</i>	10,886	5,030
{ <i>Howe</i>	6,557	4,245
{ <i>Bellerophon</i>	7,551	4,270
{ <i>Glatton</i>	4,912	2,709
{ <i>Boadicea</i>	4,027	2,679

Taking these vessels in pairs, the first two illustrations show how widely different may be the tonnages B.O.M. when the displacements are very close to one another; while the last two illustrations show how, with nearly identical tonnages

B.O.M., the displacements may differ considerably. For war-ships, displacement is undoubtedly the fairest measure, and for all ships B.O.M. tonnage only affords a means of fairly comparing ships of the same class ; it cannot be trusted where ships of different types are being compared.

Such a rule could be evaded with ease when the object aimed at was the production of vessels of small nominal tonnage, but of great cargo-carrying capacity. Raking sternposts and other small devices helped to this end, but it was above all favoured by the construction of deep narrow ships. Such vessels were, of course, far inferior to vessels of proper proportions as regarded safety and good behaviour at sea ; and the numerous disasters which resulted from the construction of these vessels, being obviously traceable to the bad effects of the tonnage law, led to its abolition for the mercantile marine.

In war-ships there was not the same temptation to sacrifice good qualities in order to make the tonnage B.O.M. appear small ; and the fact explains the continued use of the rule for her Majesty's ships long after it had ceased to have any legal force. On the other hand, the study of our naval history leads to the conclusion that every marked change or improvement made during the present century in the construction of ships for the Royal Navy has been accompanied by a protest against or disregard of the existing limitations of tonnage (B.O.M.) for the different classes of ships. And now the final step has been taken which will probably lead to the abandonment of this mode of measurement for the Royal Navy, and the substitution of displacement.

In the measurement of ships belonging to the navy of the United States the common practice appears to have been to employ builders' old measurement, but in the monitors, which are extremely broad shallow vessels, where the depth is much less than half the breadth, the depth appears to have been substituted for the half-breadth. One objection to the B.O.M. rule is thus removed, but even in this modified form it affords no fair means of comparison.

Yacht measurement next claims attention. The Thames rule is that generally adopted, and it is as follows:—

(a) The length is measured on the deck from the fore part of the stem to the after part of the sternpost (CD in Fig. 27, page 43); let this be called L.

(b) The breadth is measured to the outside of the outside plank at the broadest part wherever found; let this be called B.

(c) From the length the breadth extreme is deducted, the remainder being the "length for tonnage." This length for tonnage is multiplied by the breadth, and their product by half the breadth; the result divided by 94 gives the tonnage. In algebraical language,

$$\text{Tonnage (Thames measurement)} = \frac{(L - B) \times B \times \frac{B}{2}}{94}.$$

As an example, take the case of a yacht for which the length (L) is 102 feet; breadth extreme (B) 21 feet:

$$\begin{aligned} \text{Tonnage (Thames measurement)} &= \frac{(102 - 21) \times 21 \times \frac{21}{2}}{94} \\ &= \frac{81 \times 21 \times 21}{94 \times 2} = 190 \text{ tons.} \end{aligned}$$

The modifications of the B.O.M. rule are not of any great importance, except that the measurement of the length along the deck, instead of along the keel, does away with any motive to rake the sternpost excessively in order to decrease the nominal tonnage. In other respects the objections urged above to the B.O.M. rule apply almost with equal force here; but there is one important exception. Yachts are measured mainly for time allowance in racing, and the owner has not the same inducements to malform the vessel in order to give her increased carrying power which the owner of the cargo-carrying vessel had. The yachtsman seeks to secure speed, and for that purpose favours good proportions. Numerous and weighty objections have,

however, been raised to the Thames measurement, and various proposals have been made for alternative methods, but none of these has found much favour, or been extensively adopted.

Displacement tonnage has been advocated for yachts, but objected to on the grounds that it would lead to the construction of mere racing machines, having very small internal accommodation, as compared with the extreme dimensions; also that variations in the amount of ballast carried at different times would necessitate variations in the displacement for the same yacht; while many owners would object to having their yachts measured accurately, fearing that their forms might be reproduced or improved upon. None of these objections, except perhaps the first, appears to have any great weight; but there seems no present probability of displacement tonnage being accepted for yachts.

The great fault of the Thames measurement is undoubtedly the retention of the assumption made in the rule for B.O.M. tonnage, that the depth may be taken as half the breadth. Hence have arisen proposals to substitute either the maximum draught of water or the actual depth (from deck to keel) for the half-breadth in the formula given above. The Corinthian and New Thames Yacht Clubs have adopted a rule differing from ordinary Thames measurement, in taking the total depth up to the top of the covering board, but having the length and breadth for tonnage measured on the old plan. By this rule,

$$\text{Tonnage of yachts} = \frac{L \times B \times \text{depth}}{200}.$$

The divisor (200) makes the tonnage approach to the older measurement. One obvious objection to the Corinthian Club measurement is that owners desiring to decrease the nominal tonnage would be tempted to decrease the free-board, or height out of water, in order to diminish the depth; and such a change might be very objectionable. On the other hand, the introduction of the *total depth* of the yacht into the formula prevents slight differences of

draught, due to alterations in the weights carried, from causing changes in the nominal tonnage, as they would do if the actual displacement tonnages were employed. There seems no weighty objection, however, to taking the maximum displacement for a yacht as her tonnage, and neglecting the effects of comparatively small changes of draught.

The New York Yacht Club settle time allowances quite apart from "tonnage." Their tables are based upon the area obtained by multiplying the extreme length of the yacht on or under the water-line from the fore side of the stem to the aft side of the sternpost by the extreme breadth wherever found. It would appear to be assumed in this rule that the power to carry sail varied with the area obtained by multiplying these two dimensions; but this is only an approximate rule, the true law for sail-carrying power depending upon more complex conditions, not now to be discussed. This rule is said to have given satisfaction in New York, but it has not been adopted here.

Summing up these different rules for yacht measurement, it must be admitted that no plan yet proposed is free from objection; the two most trustworthy methods appear to be "displacement tonnage" and "register tonnage." All yachts are measured for their register tonnage, under the law of 1854, just as other ships are measured; but no use is made of the measurement in racing. With certain limitations as to the thickness of the sides in yachts, the register tonnage might be made to give a very fair approximation to a constant fraction of the total bulk, measured to the outside of the skin and the top of the planking of the upper deck. Here, however, as in the Corinthian Club rule, there would be an inducement to decrease freeboard in order to diminish the tonnage; whereas with displacement tonnage there would be no such inducement.

Turning to *register tonnage*, the legal measurement for British merchant ships since 1854, one finds a method

resting upon a scientific basis, not easily evaded by persons desirous of making the nominal tonnage of their ships small, and generally commending itself after more than twenty years' experience. Many other nations have adopted the same or very similar laws; Germany, Austria, France, Italy, Denmark, and the United States among the number; and the Suez Canal tariff is based upon the same method of measurement. Register tonnage was thus defined by Mr. Moorsom, who had most to do with its introduction:—

“It is simply the internal capacity of the hold of the ship
“ in cubic feet, with any additional spaces built on deck,
“ divided by one hundred. . . . The nominal ton of the
“ present law consists simply of one hundred cubic feet.”

The tonnage of a *merchant* ship is usually stated both as “gross” and “nett.” “Gross” tonnage expresses (in tons of 100 cubic feet) the total internal capacity of the ship, together with that of any closed-in spaces, such as deck-houses, &c., erected upon the deck, for purposes of accommodation or stowage. “Nett” tonnage is intended to express in the same units the cubical content of the space actually available for remunerative service, the conveyance of passengers, or stowage of cargo; it is sometimes styled the “register” tonnage. In calculating the tonnage, the surveyors of the Board of Trade take certain measurements in the interior of the ship, if that is accessible, the number and position of these measurements being settled by the tonnage law, in proportion to the size of the ship, and being sufficiently close to one another, to prevent unfair decrease of the tonnage by local thickening of the inside lining, or any such devices. These measurements are made the basis of a calculation very similar in character to that by which the displacement of a ship is estimated by the naval architect; and so an exceedingly close approximation is made to the internal capacity below the tonnage deck. To this is added the space between decks, and the closed-in spaces (if any), the final result being the gross tonnage.

In some cases the holds of ships cannot be cleared for purposes of measurement, and then the gross tonnage under the deck is estimated as follows. The length is taken at the upper deck from the fore point of the rabbet of the stem to the after point of the rabbet of the post. The extreme breadth of the ship is also taken, and a chain is passed under her at this place, in order to determine the girth of the ship, as high up as the upper deck. The formulæ now employed by the surveyors in calculating the approximate tonnage by rule 2 are :—*

$$(1) \text{ For wood and } \left. \begin{array}{l} \text{composite ships .} \end{array} \right\} = \frac{17}{10000} \left(\frac{\text{Girth} + \text{Breadth}}{2} \right)^2 \times \text{Length}.$$

$$(2) \text{ For iron ships .} = \frac{18}{10000} \left(\frac{\text{Girth} + \text{Breadth}}{2} \right)^2 \times \text{Length}.$$

But these rules are only used when internal measurement is either very inconvenient or impracticable.

In the Merchant Shipping Act of 1854, rule 2 was stated as follows. The length was taken on the upper deck between the outside of the outer plank at the stem and the after side of the sternpost, deducting from this the distance from the after side of the sternpost and the rabbet of the sternpost at the point where the counter plank crossed it. The girth and breadth extreme were taken as described above; and the formulæ for the gross tonnage were :—

$$\text{For wood ships . . .} = \frac{18}{10000} \left(\frac{\text{Girth} + \text{Breadth}}{2} \right)^2 \times \text{Length}.$$

$$\text{For iron ships} = \frac{21}{10000} \left(\frac{\text{Girth} + \text{Breadth}}{2} \right)^2 \times \text{Length}$$

These coefficients were, however, exchanged many years ago for the smaller coefficients given above.

Mr. Moorsom also gave the following approximate rules for the gross register tonnage of merchant ships in terms

* See an able article on "Register Tonnage in Practice," in *Naval Science* for 1873.

of their principal dimensions in a paper contributed to vol. i. of the *Transactions* of the Institution of Naval Architects.

Let L = inside length on upper deck from plank at bow to plank at stern ;

B = inside main breadth from ceiling to ceiling ;

D = inside midship depth from upper deck to ceiling at limber strake.

Then the register tonnage for a ship in the under-mentioned classes will approximately equal $\frac{L \times B \times D}{100} \times$ the decimal factor opposite the class.

	Decimal factor.
Sailing-ships of usual form7
Steam-vessels and clippers { Two-decked65
{ Three-decked68
Yachts { Above sixty tons5
{ Small vessels45

As an example take the case (from the Mercantile Navy List) of a steamer for which $L = 137$ feet ; $B = 20$ feet ; $D = 11$ feet.

$$\text{Approximate tonnage} = \frac{137 \times 20 \times 11}{100} \times .65 = 195 \text{ tons.}$$

Measured tonnage = 199 tons.

All her Majesty's ships are now measured by surveyors of the Board of Trade, and their register tonnage is recorded in their papers; the above rules may, however, prove of some service, enabling a fair approximation to the tonnage to be rapidly made in terms of dimensions that are readily ascertainable.

The "nett" register tonnage of sailing ships differs very

little from the "gross" tonnage; the only deductions being spaces occupied solely by the crew, provided they do not fall below 72 cubic feet per man; cargo must not be carried in any such spaces, or the deductions cease to be made. In steam-ships further deductions are permitted on account of the spaces occupied by the machinery and coals, such spaces being regarded as lost to the cargo-carrying capacity of the vessel, and therefore not remunerative. The fundamental principle, that nett register tonnage (upon which the dues are estimated for any ship) shall only include spaces used for cargo-carrying or passenger accommodation is thus maintained; but the fairness of making any such allowances to steamers, or, if any, how great allowances, has been the subject of much discussion. The Act of 1854 is still in force, however, although confessedly imperfect, and under it the deductions are made in one of two ways. The space "solely occupied by and necessary for the "proper working of the boilers and machinery" is measured (shaft passages, funnel casings, ventilation trunks, &c., being included herein). If this space has a tonnage, in screw-steamers, above 13 per cent. of the gross tonnage and under 20 per cent., the total deduction permitted, for machinery and coal-space, is 32 per cent. of the gross tonnage. In paddle-steamers, if the measured space has a tonnage above 20 per cent. and under 30 per cent. of the gross tonnage, the total deduction permitted is 37 per cent. This is the first, or "percentage," method supposed to be applicable to all ordinary steamers. The second method is applied where the space occupied for the machinery is either unusually large or small; the space may then be measured (as before), and the total deduction from the gross tonnage is to be 50 per cent. more than the measured space in paddle-steamers, and 75 per cent. in screw-steamers. These additions to the measured space are considered to allow fairly for the coal-stowage required for the propulsion of the ship. Slight variations, such as may be made in the erections on deck, might

suffice to throw a vessel out of the percentage allowances, and into the second rule, increasing her nett register tonnage considerably. For example, a screw-vessel of 2000 tons gross tonnage may be supposed to have machinery space equivalent to 265 tons (26,500 cubic feet), or $13\frac{1}{4}$ per cent. of the gross tonnage. A closed-in poop and forecastle are added, increasing the gross tonnage to 2080 tons, 13 per cent. of which would be 270 tons. The machinery space would then be 5 tons below the lower limit for the percentage method, and the rule might be had recourse to which allows a total deduction of 75 per cent. more than the measured space. So the ship in her two conditions would stand as follows:—

	Tons.
I. Without poop and forecastle—	
Gross tonnage	2000
Deduction for machinery and coals, $\frac{3\frac{1}{2}}{100} \times 2000$ tons . .	640
Nett tonnage	1360
II. With poop and forecastle—	
Gross tonnage	2080
Deduction for machinery and coals, $1\frac{1}{4} \times 265$ tons . .	464
Nett tonnage	1616

The addition of the poop and forecastle only adds 80 tons to the real cargo-carrying space of the ship; but by the operation of the tonnage law the change might increase the nett register tonnage by no less than 256 tons. A system which may give rise to such anomalous results must obviously be open to objection; the real cause of the difficulty being found in the hard and fast limits within which the percentage rule is applied. For although the Act of 1854 gave power to extend the application of the percentage method, with the consent of the government officers and the owner, we are assured on good authority that the Board of Trade seldom agrees to give the percentage allowance where the machinery space is less than 13 per cent. of the gross tonnage.

Ordinary ocean-going steamers will usually be found to

have a nett register tonnage about 33 to 35 per cent. less than their gross tonnage. Take for example the following large steamers:—

Ships.	Gross Tonnage.	Nett Tonnage.
	Tons.	Tons.
<i>City of Berlin</i>	5491	2957
<i>Britannic</i>	5004	3152
<i>City of Montreal</i>	4451	3027
<i>Haytian</i>	2336	1490
<i>Holland</i>	3847	2462
<i>Abyssinia</i>	3376	2159
<i>Palmyra</i>	2044	1390

The Mercantile Navy List furnishes extensive information of a similar character for all classes of steamers. In vessels with very great engine-power, such as tugs or fast packet-boats, the deductions from the gross tonnage according to the law of 1854 reach a very high percentage. Instances are on record, for example, where tugs of considerable gross tonnage have by these deductions been made to have practically *no* nett tonnage. The well-known Clyde steamer *Iona*, which has a great reputation for speed, has a gross tonnage of 393 tons, and a nett tonnage of 113 tons—only about 29 per cent. of the gross tonnage. A similar case is found in the Holyhead packets; the *Connaught*, for instance, having a gross tonnage of 1412 tons, and a nett tonnage of 450 tons, or only 32 per cent. of the gross tonnage.

Such excessive reductions have been much objected to, and in vessels like the *Connaught*, for example, built for short passages, and consequently requiring but a small coal supply, an obvious absurdity is involved in allowing 75 per cent. on the measured machinery space as the coal space. The Merchant Shipping Code introduced into Parliament in 1871, but not proceeded with, proposed an amendment of the law, which has been much commended, and which may be considered to fairly represent official experience up to that time. The deduction for engine and coal space by this code would never be permitted to exceed

50 per cent. of the gross tonnage, except in tugs. Accurate measurements were to be made of the *coal-bunkers*, as well as of the engine and boiler rooms, funnel casings, shaft passages, &c.; and the total tonnage corresponding to the spaces measured was to be deducted from the gross tonnage. This plan would probably answer admirably in the case of ships with permanent coal-bunkers; but many cargo-carrying steamers are constructed with shifting coal-bunker bulkheads; the space assigned to the coal varying with the quantity required to be carried for the particular voyages, and the space sometimes included in, and at others excluded from, the bunkers being unavailable or available for cargo stowage. Since the nett register tonnage cannot be allowed to vary with the coal space, some modification of the rule would be necessary for such cases.

The so-called "Danube rule" for tonnage is based upon the English tonnage law of 1854, the allowance for coal and machinery being 50 per cent. above the measured space assigned to machinery in paddle-steamers, and 75 per cent. in screw-steamers.

The tariff of the Suez Canal is also based upon the English tonnage law of 1854, together with the modifications proposed in the Code of 1871 as to coal space. Ships of the Royal Navy now make such great use of the canal that it may be well to summarise the method of measurement for the "nett tonnage" upon which the dues are charged. The spaces measured for the gross tonnage in *all* ships are:—Space under the tonnage deck; space or spaces between tonnage deck and uppermost deck; all covered or closed-in spaces, such as poop, forecastle, officers' cabins, galleys, cook-houses, deck-houses, wheel-houses, and other enclosed or covered-in spaces employed for working the ship. The deductions permitted in all ships are:—Berthing accommodation for the crew in forecastle and elsewhere—not including spaces for stewards and passengers' servants; berthing accommodation for the officers, except the captain; galleys, cook-houses, &c., used exclusively for the crew;

covered and closed-in spaces above the uppermost deck employed for working the ship. In none of these spaces must cargo be carried or passengers berthed, and the total deduction under all these heads must not exceed 5 per cent. of the gross tonnage. In steamers with *fixed* coal-bunkers the rule of the English code may be followed, or the owners may choose to have their vessels measured by the Danube rule. Vessels with *shifting* bunkers would be measured by the Danube rule. In no case, except in tugs, must the deduction for the propelling power exceed 50 per cent. of the gross tonnage; so that the minimum tonnage upon which a vessel can pay dues in passing through the canal is 45 per cent. of her gross tonnage. The smaller classes of war-ships, up to corvettes, would approach this lower limit most closely; frigates, troop-ships, and high-sided vessels may have nett tonnages from 50 to 65 per cent. of the gross tonnages.

Since the gross register tonnage of a ship represents her internal capacity, while the sum of her displacement and reserve of buoyancy represent her total outside bulk, there will necessarily exist a certain ratio between the gross tonnage and the displacement in ships having the same proportionate reserve of buoyancy and the same proportionate thickness of sides and decks. In different classes considerable differences must exist in the ratio of gross tonnage to displacement, since there are very wide divergencies in the reserves of buoyancy and the methods of construction. It may, however, be worth notice that in ocean-going steamers, both mercantile and fighting, the displacement (in tons), when fully laden, may be expected to lie between once and a half and twice the gross tonnage; and the mean of these ratios ($1\frac{3}{4}$ time) will give a fair approximation to the load displacement in most cases.

It only remains to add the following practical rule, given by Mr. Moorsom:—"To ascertain approximately the dead-weight cargo which a ship can safely carry on an average length of voyage, deduct the tonnage of the spaces appro-

“priated to passenger accommodation from the nett register tonnage, and multiply the remainder by the factor $1\frac{1}{2}$.” This rule is based on experience, about 67 cubic feet being the average space required for each ton-weight of cargo carried, when allowance is made for the provisions and stores needed on a voyage of average length.

A few words will suffice as to *freight tonnage*. Merchants and shipowners make considerable use of this measurement, although it has no legal authority; it is also used in the Admiralty service in connection with store-ships and yard-craft. A freight-ton, or “unit of measurement cargo,” simply means 40 cubic feet of space available for cargo, and is therefore two-fifths of a register ton. Mr. Moorsom says that for an average length of voyage the nett register tonnage less the tonnage of the passenger space, when multiplied by the factor $1\frac{2}{3}$, will give a fair approximation to the freight-tons for cargo stowage. This rule has the same basis as that for dead-weight cargo given above. The freight-ton is, of course, a purely arbitrary measure, but has a definite meaning, and is of service in the stowage of ships.

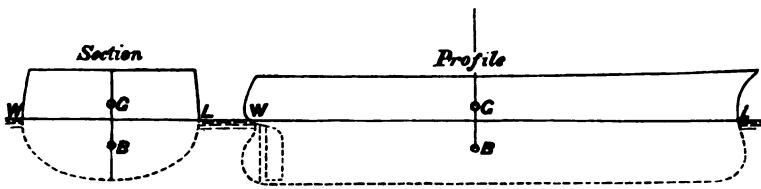
CHAPTER III.

THE STATICAL STABILITY OF SHIPS.

A SHIP floating freely and at rest in still water must fulfil two conditions: first, she must displace a weight of water equal to her own weight; second, her centre of gravity must lie in the same vertical line with the centre of gravity of the volume of displacement, or "centre of buoyancy." In the opening chapter the truth of the first condition was established, and it was shown that the circumstances of the surrounding water were unchanged, whether the cavity of the displacement was filled by the ship or by a volume of water having the same weight as the ship. When the ship occupies the cavity, the whole of her weight may be supposed to be concentrated at her centre of gravity, and to act vertically downwards. When the cavity is filled with water, its weight may be supposed to be concentrated at the centre of gravity of the volume occupied (i. e. at the centre of buoyancy), and to act vertically downwards; the downward pressure must necessarily be balanced by the equal upward pressures, or "buoyancy," of the surrounding water; therefore these upward pressures must have a resultant also passing through the centre of buoyancy. In Fig. 28, a ship is represented (in profile and transverse section) floating freely and at rest in still water. Her total weight may be supposed to act vertically downward through the centre of gravity G ; the buoyancy acting vertically upwards through the centre of buoyancy B . If (as in the diagram) the line joining the centres G and B is vertical, it obviously repre-

sents the common line of action of the weight and buoyancy, which are equal and opposite vertical forces; in that case the ship is subject to no disturbing forces, and remains at rest, the horizontal fluid pressures which act upon her being balanced amongst themselves. But if (as represented in Fig. 29) the centres G and B are not in the same vertical line, the equal and opposite forces of the weight and buoy-

FIG 28



ancy do not balance each other, but form a "mechanical couple," tending to disturb the ship, either by heeling her or by producing change of trim. If D = total weight of the ship (in tons), and GZ = perpendicular distance between the parallel lines of action of the weight and buoyancy (in feet),

$$\text{Moment of couple} = D \times GZ \text{ (foot-tons).}$$

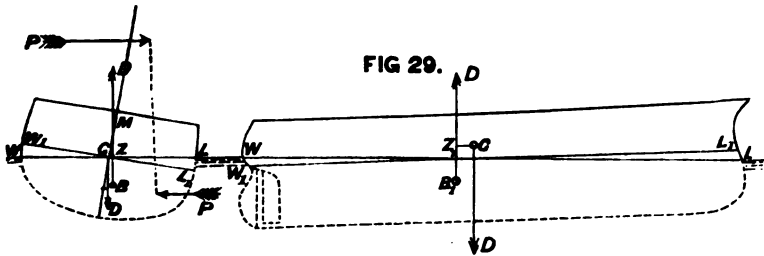


FIG 29.

If the vessel is left free to move from this position, not being subjected to the action of external forces other than the fluid pressures, she will either heel or change trim, until the consequent alteration in the form of the displacement brings the centre of buoyancy into the same vertical with the centre of gravity G. It is important to note that, for any specified distribution of weights in a ship, supposing no change of place in those weights to accompany her transverse or

longitudinal inclinations, the centre of gravity is a *fixed point in the ship*, the position of which may be correctly ascertained by calculation. On the contrary, the centre of buoyancy varies in position as the ship is inclined, because the form of the displacement changes. Hence, in treating of the stability of ships, it is usual to assume that the position of the centre of gravity is known, and to determine the place of the centre of buoyancy for the volume of displacement corresponding to any assigned position of the ship. The value of the "arm" (GZ) of the mechanical couple formed by the weight and buoyancy can then be determined. If it is zero, the vessel floats freely and at rest, in other words, occupies a "position of equilibrium;" if the arm (GZ) has a certain value, the moment of the couple ($D \times GZ$) measures the effort of the ship to change her position in order to reach a position of equilibrium. In this latter case the vessel can only be retained in the supposed position (see Fig. 29) by means of the action of external forces; and if her volume of displacement is to remain the same as when she floats freely, these external forces may be supposed to act along horizontal lines. For example, a ship may be sailing at a steady angle of heel, and the resultant pressure of the wind on the sails may be represented by the pressure P in Fig. 29 (section) acting along a horizontal line. When the vessel has attained a uniform rate of drift to leeward, the resistance of the water will contribute a horizontal pressure, P, equal and opposite to the wind-pressure; and if d be the vertical distance between the lines of action of these pressures, we have

$$\left. \begin{array}{l} \text{Moment of couple formed by} \\ \text{horizontal forces} \end{array} \right\} = P \times d \text{ (foot-tons);}$$

which moment will be balanced by that of the couple formed by the weight and buoyancy. Hence

$$D \times GZ = P \times d,$$

is an equation enabling one to ascertain the angle of steady

heel for a particular ship, with a given spread of sail, and a certain force of wind.

Supposing a ship, when floating upright and at rest, to be in a position of equilibrium, which is the common case: let her be inclined through a very small angle from the initial position by the action of horizontal forces. If, when the inclining forces are removed, she returns toward the initial position, she is said to have been in *stable equilibrium* when upright; if, on the contrary, she moves further away from the initial position, she is said to have been in *unstable equilibrium* when upright; if, as may happen, she simply rests in the slightly inclined position, neither tending to return to the upright nor to move from it, she is said to be in *neutral* or *indifferent equilibrium*. This last-named condition has, however, little practical interest in connection with ships, for which stability and instability are alone important. A well-designed ship floats in stable equilibrium when upright; but many ships, when floating light, without cargo or ballast, are in unstable equilibrium when upright, and consequently "loll over" to one side or the other when acted upon by very small disturbing forces.

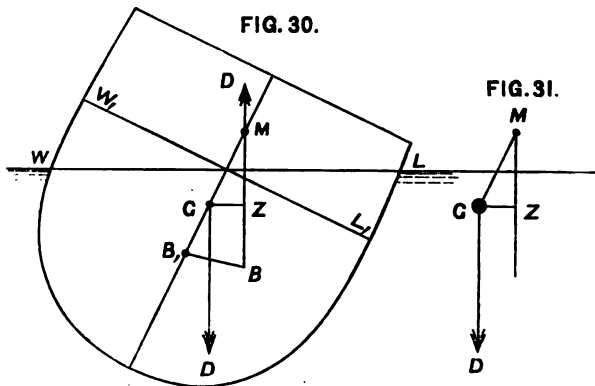
The *statical stability* of a ship may be defined as the effort which she makes when inclined by external forces acting horizontally, and held *steadily* at that inclination, to return towards her natural position of equilibrium—the upright—in which she rests when floating freely. This effort, as explained above, is measured by the moment of the couple formed by the weight and buoyancy. Hence we may write, for any angle of inclination,

$$\text{Moment of statical stability} = D \times GZ.$$

But in doing so, it must be noted that in all ships, when large angles of inclination are attained, the line of action of the buoyancy, instead of falling to the right of G (as in section, Fig. 29), and so tending to restore the ship to the upright, will fall to the left and tend to *upset* her or make

her move away from the upright position. This matter will be more fully explained hereafter.

Starting from the upright, a ship may be inclined transversely, or longitudinally, or in any "skew" direction lying between the two. It is only necessary, however, to consider transverse and longitudinal inclinations in connection with statical stability; the innumerable possible skew inclinations being easily dealt with when the conditions of stability for the two principal inclinations have been ascertained. The *minimum* stability of a ship corresponds to transverse inclinations; the *maximum* stability, to longitudinal inclinations. It is, therefore, of the greatest importance to thoroughly investigate the changes in the statical stability of ships as they are heeled to greater and greater transverse inclinations, especially for ships which have masts and sails. Longitudinal stability is less important, but claims some notice, especially as regards its influence on changes of trim and pitching motions.



Taking first transverse inclinations, let them be supposed to be small; it is then easy to estimate the statical stability when the position of the *metacentre* is known. For our present purpose the metacentre may be defined, with sufficient exactitude, as the intersection (M in the cross-section, Fig. 30) of the line of action (BM) of the buoyancy when the ship is inclined through a very small angle, with the line of action

(B_1GM) of the buoyancy when the ship is upright and at rest. In vessels of ordinary form, no great error is introduced by supposing that, for angles of inclination between the upright and 10 or 15 degrees, all the lines of action of the buoyancy (such as BM) pass through the same point (M)—the metacentre. For any angle of inclination a within these limits the perpendicular distance (GZ) of the line of action of the buoyancy from the centre of gravity is determined by—

$$GZ = GM \sin a.$$

$$\text{Moment of statical stability} = D \times GM \sin a.$$

As an example, take a ship weighing 6000 tons, for which the distance $GM = 3$ feet, and suppose her to be steadily heeled under canvas at an angle of 9 degrees. Then

$$\begin{aligned} \text{Moment of statical stability} &= 6000 \text{ tons} \times 3 \text{ feet} \times \sin 9^\circ \\ &= 18,000 \times .1564 = 2815 \text{ foot-tons.} \end{aligned}$$

For most ships the angles of steady heel under canvas lie within the limits for which the metacentric method holds; and consequently this method may be used in estimating the “stiffness” of a ship, i.e. her power to resist inclination from the upright by the steady pressure of the wind on her sails. It must be noticed that this term “stiffness” is used by the naval architect in a sense distinct from “steadiness.” A *stiff* ship is one which opposes great resistance to inclination from the upright, when under sail or acted upon by some external forces; a *crank* ship is one very easily inclined; the sea being supposed to be *smooth and still*. A *steady* ship, on the contrary, is one which, when exposed to the action of waves in a seaway, keeps nearly upright, her decks not departing far from the horizontal. Hereafter it will be shown that frequently the *stiffest* ships are the *least steady*, while crank ships are the steadiest in a seaway. At present we are dealing only with still water, and must limit our remarks to stiffness.

From the foregoing remarks it will be evident that, so far as statical stability is concerned, and within the limits to which the metacentric method applies, a ship may be compared to a pendulum, having its point of suspension at the

metacentre (M, Fig. 30), and its weight concentrated in a "bob" at the centre of gravity G. Fig. 31 shows such a pendulum, inclined to an angle a . The weight (D) acting downwards produces a tendency to return to the upright, measured by the moment $D \times GM \sin a$, which is identical with the expression for the righting moment of the ship at the same angle. But this comparison holds only while the ship and the pendulum are at rest; as soon as motion begins, the comparison ceases to be correct, and the failure to distinguish between the two cases has led some writers into serious error.

Changes in the height (GM) of the metacentre above the centre of gravity produce corresponding changes in the stiffness of a ship; in fact, the stiffness may be considered to vary with this height—usually termed the "metacentric height." If it is doubled, the stiffness is doubled; if halved, the stiffness is reduced by one-half, and so on. Care has, therefore, to be taken by the naval architect, in designing ships, to secure a metacentric height which shall give sufficient stiffness, without sacrificing steadiness in a sea-way. In adjusting these conflicting claims, experience is the best guide. The following tables contain particulars of the metacentric heights of different classes of war-vessels belonging to the Royal Navy or to foreign navies; the vessels being fully laden.

Ironclads.	Metacentric Height (GM).
1. Converted frigates (formerly two-deckers); <i>Prince Consort</i> class in Royal Navy, and earliest French frigates (<i>Gloire</i> class)	Feet. 6 to 7
2. <i>Warrior</i> and <i>Minotaur</i> classes in Royal Navy; <i>Flandre</i> class in French navy	4 " 4½
3. Recent types of frigates, such as <i>Bellerophon</i> , <i>Hercules</i> , or <i>Alexandra</i> in Royal Navy	2½ " 3½
4. <i>Marengo</i> class (last completed) in French navy	1½ " 2½
5. <i>Alma</i> class of corvettes in French navy	3
6. <i>Devastation</i> class of Royal Navy	3½ " 4
7. <i>Glatton</i> (low freeboard monitor)	About 7
8. <i>Garde-côtes</i> (<i>Bélier</i> class), French navy	" 7½
9. American type of monitor (<i>Miantonomoh</i>)	" 14

It is to be noted that the first five groups in this table include *sailing* ironclads. Experience has led to the selection of metacentric heights of from 3 to 4 feet as the best suited for such vessels, taking into account their ordinary spread of canvas. The remaining groups comprehend mastless ships, in which the greater metacentric heights are often unavoidable with the forms and proportions rendered necessary by the special conditions of the designs—such as moderate draught in association with thick armour and heavy guns.

Unarmoured Ships.	Metacentric Height (GM).
	Feet.
1. Screw line-of-battle ships (two-deckers), of which a few remain in the French and Royal navies . . .	} From 4½ to 6½
2. Screw frigates and corvettes of the old types . . .	
3. Screw frigates of new type and very high speed, such as <i>Inconstant</i> class of Royal Navy, or <i>Tourville</i> of French navy	
4. Screw corvettes and sloops of recent design.	} „ 2½ „ 3
5. Smaller classes of sea-going vessels	} „ 2½ „ 3
6. Tugs and small vessels, not sea-going	} „ 1½ „ 2

When the consumable stores of these vessels, armoured and unarmoured, are removed, the metacentric heights are commonly about one foot less than in the fully laden condition to which the tables refer. For merchant ships, corresponding particulars are not on record, few experiments having been made to determine them; moreover, in these vessels variations in stowage of cargo must produce considerable variations in the metacentric heights. There is reason to believe that recent merchant steamers, having extreme proportions of length to breadth, have metacentric heights much less than those stated above for war-ships.

The naval architect usually has far greater control over the vertical position of the metacentre in a newly designed ship than he has over that of the centre of gravity. In a war-ship the distribution of the armour, armament, and equipment are settled mainly with reference to fighting efficiency; and

this distribution chiefly controls the vertical position of the centre of gravity. Merchant ships have to fulfil specified conditions as to draught, freeboard, and carrying power, besides being subject to variations in the character and stowage of the cargoes; and these variations may produce considerable changes in the vertical position of the centre of gravity, even when the total loads carried are identical on different voyages. On the other hand, the position of the metacentre in a ship depends only on her form, and the extent to which she is immersed; it is quite independent of the structural arrangements or the lading. Two ships of identical form, immersed to the same extent, and therefore having equal displacements, may have the equal weights carried so differently disposed that the centre of gravity in one will be considerably higher than that in the other; but the metacentres will occupy the same position in both vessels. By means of changes in the form of the water-line section and displacement, in the proportions of length to breadth, or in draught of water, the designer can, however, associate with a constant total weight, or displacement, very various vertical positions of the metacentre.

It has been explained that the metacentre affords a ready means of determining the line of action of the buoyancy for any inclined position, and avoiding the necessity for determining the place of the corresponding centre of buoyancy. But in practice the position of the metacentre is fixed with reference to the centre of buoyancy, corresponding to the upright position of the ship. The distance (B_1M , Fig. 30) is given by the formula,*

$$B_1M = \frac{\text{Moment of inertia of water-line area}}{\text{Volume of displacement}}$$

* The "moment of inertia" of an area may be defined as the sum of products of each element of that area, by the square of its distance from the axis about which the moment of

inertia is to be calculated. The proof of the formula given above involves mathematical treatment which would be out of place here.

For transverse inclinations, such as we are now considering, the moment of inertia would be calculated about the middle line of the water-line section; and this may be expressed in terms of the length (L) and breadth extreme (B) of that section. It may in fact be written,

$$\text{Moment of inertia} = K \times L \times B^3,$$

where K is a quantity ascertained by calculation for the particular ship. Since the *cube* of the breadth appears in the expression for the moment of inertia, and only the first power of the length, any increase in the breadth must be most influential in adding to the value of the height (B_1M) of the metacentre above the centre of buoyancy.

Referring once more to the box-shaped vessel, Fig. 10, page 18, the water-line section is a rectangle, and $K = \frac{1}{12}$. Let two cases be taken; and suppose the draught of water to be constant, say 20 feet. In the first case suppose $L = 200$ feet; $B = 40$ feet. Then displacement $D = 200 \times 40 \times 20 = 160,000$ cubic feet.

$$B_1M = \frac{\frac{1}{12} \times 200 \times (40)^3}{160,000} = 6\frac{3}{4} \text{ feet.}$$

In the second case, suppose the breadth to be made 50 feet, and the length 160 feet; then the displacement will be the same as before. But

$$B_1M = \frac{\frac{1}{12} \times 160 \times (50)^3}{160,000} = 10\frac{5}{12} \text{ feet.}$$

In both these cases, the centre of buoyancy is obviously at mid-draught, so that the effect of changing the proportions of length to breadth in the manner supposed is to make a difference of $3\frac{3}{4}$ feet in the height of the metacentre above the bottom of the vessels.

The case of ship-shaped forms is more difficult; the form of athwartship sections varies throughout the length, and the estimate of the displacement and positions of the centre of buoyancy and metacentre involves lengthy calculations. The data for these calculations are furnished by the draw-

ings of a ship. The process cannot now be described, being too technical. It may, however, be interesting to state two simple rules, making no pretension to accuracy, but enabling the positions of the centre of buoyancy and the metacentre to be fixed approximately.

I. For the approximate depth of the centre of buoyancy below the surface of the water, take from *two-fifths* to *nine-twentieths* of the mean draught. The larger coefficient should be used for ships of full form.

II. For the coefficient K in the formula for the moment of inertia of the water-line area—or plane of flotation—the following approximate values may be taken in ordinary types of war-ships:—

$$\text{Length} = \text{four beams} : K = \frac{3}{50};$$

$$\text{Length} = \text{five beams} : K = \frac{11}{200};$$

$$\text{Length} = \text{six beams} : K = \frac{1}{20}.$$

The length and beam are measured at the load-line.

It will be understood that these values of K may vary in different vessels, having the same ratio of length to extreme breadth. Fineness of form in the water-line section may be adopted to decrease the resistance, or for other reasons; but its effect will be to decrease the value of K, and in some ships having a length of four beams only, K is in this manner made as small as for vessels six beams in length with the ordinary fulness of water-line. When fineness of form is associated with great proportionate length, K sometimes falls as low as $\frac{1}{25}$; but this is an uncommon case. Fulness of form at the water-line has of course the contrary effect, making K greater than it is ordinarily in vessels of the same proportions of length to beam. All these circumstances require consideration in selecting the value for K in any case.

As an example, take her Majesty's ship *Iron Duke*, for which length (L) is 280 feet, breadth extreme (B) 54 feet,

mean draught 22 feet, displacement 6000 tons. Here the length equals about five beams; and K should about equal $\frac{11}{200}$. Hence

$$\begin{aligned} \left. \begin{array}{l} \text{Moment of inertia of water-} \\ \text{line area} \end{array} \right\} &= \frac{11}{200} \times 280 \times (54)^3. \\ \text{Volume of displacement} &= 6000 \times 35. \\ \left. \begin{array}{l} \text{Height of metacentre above} \\ \text{centre of buoyancy (B,M)} \end{array} \right\} &= \frac{11 \times 280 \times (54)^3}{200 \times 6000 \times 35} = 11.5 \text{ feet} \\ \left. \begin{array}{l} \text{Also (by Rule I.) approxi-} \\ \text{mate depth of centre of} \\ \text{buoyancy below water} \\ \text{surface} \end{array} \right\} &= \frac{2}{3} \times 22 \text{ feet} = 8.8 \text{ feet.} \end{aligned}$$

Hence the metacentre should be situated about 2.7 feet above the water surface. Exact calculation showed it to be about 2.4 feet above the water surface,* the approximation being close.

Limited space prevents any other example being given; but it will be seen from the foregoing example how to proceed generally in making these approximations to the vertical position of the metacentre in ships of war. Such approximations could not, however, be trusted to take the place of exact calculations.

Reverting to the expression for the height of the metacentre above the centre of buoyancy, a few general deductions may be stated. With the same water-line section, but with changes in the under-water form, involving changes in the displacement, the height of the metacentre above the centre of buoyancy will be less in *full* ships than in *fine* ships. Ships which are broad in proportion to their length and depth have great metacentric heights (B,M), and *vice versa*. Shallow-draught vessels, of considerable beam and length, have a great moment of inertia of the load-line section in proportion to the displacement, and in them the

* See page 252 of appendix to report of Committee on Designs for Ships of War.

metacentre commonly lies high above the centre of buoyancy; but so also does the centre of gravity, because these vessels generally have abnormal freeboard in proportion to draught. As ships of ordinary form become more deeply immersed, they lose in the ratio which the moment of inertia of the load-line section—or plane of flotation—bears to the volume of displacement, and the metacentre usually falls lower in the vessel, but there are exceptions to the rule.

The foregoing tables of metacentric heights furnish illustrations of these deductions, but it must be borne in mind that the vertical position of the centre of gravity affects the results given therein, so that they do not simply represent the effects of changes in form and proportions on the position of the metacentre.

The following are examples of ships which are very broad in proportion to their length and depth, and which have great metacentric heights:—

Ships.	Length.		Breadth Extreme.		Mean Draught.		Metacentric Height (GM).
	Feet	ins.	Feet	ins.	Feet	ins.	Feet.
<i>Miantonomoh</i> (American)	250	6	52	10	14	0	14·0
<i>Cerbère</i> (French)	216	0	53	0	19	0	7·6
<i>Glutton</i> (English)	245	0	54	0	19	0	6·8

The converse case of ships which are long in proportion to their breadth, and which have low metacentric heights, is illustrated by the—

Ship.	Length.		Breadth Extreme.		Mean Draught.		Metacentric Height (GM).
	Feet	ins.	Feet	ins.	Feet	ins.	Feet.
<i>Inconstant</i>	337	0	50	3½	23	10½	2·8*

* This metacentric height was obtained by placing 180 tons of ballast on board in order to make the vessel stiffer under canvas;

without the ballast the metacentric height would probably be about 2½ feet.

Moderate proportions, such as are now common in the ironclad ships of the Navy, are usually associated with moderate metacentric heights; as examples take—

Ships.	Length.	Breadth Extreme.	Mean Draught.	Metacentric Height(GM).
	Feet ins.	Feet ins.	Feet ins.	Feet.
<i>Hercules</i> . . . } English	325 0	59 0	25 0	2·7
<i>Bellerophon</i> . . . } English	300 0	56 1	24 8½	3·3
<i>Flandre class</i> . . . } French	262 0	55 9	25 3	4·4
<i>Alma class</i> . . . } French	230 0	46 3	21 3	3·5

But such moderate proportions, associated with a high position of the centre of gravity or deep draught, may give rise to a small metacentric height, as in the—

Ships.	Length.	Breadth Extreme.	Mean Draught.	Metacentric Height(GM).
	Feet ins.	Feet ins.	Feet ins.	Feet.
<i>Monarch</i> (English) . .	330 0	57 6	24 1½	2·4
<i>Richelieu</i> (French) . .	322 0	57 2	26 3	1·5

Conversely, moderate proportions associated with a low position of the centre of gravity may cause great metacentric height as in the converted ironclads.

Ships.	Length.	Breadth Extreme.	Mean Draught.	Metacentric Height(GM).
	Feet ins.	Feet ins.	Feet ins.	Feet.
<i>Prince Consort</i> (English)	273 0	58 5	25 5	6·0
<i>Gloire</i> (French) . . .	255 0	55 9	25 6	7·0

Similarly, great length in proportion to beam may, by means of fineness of form or a low position of the centre of gravity, be associated with a good metacentric height, as in the—

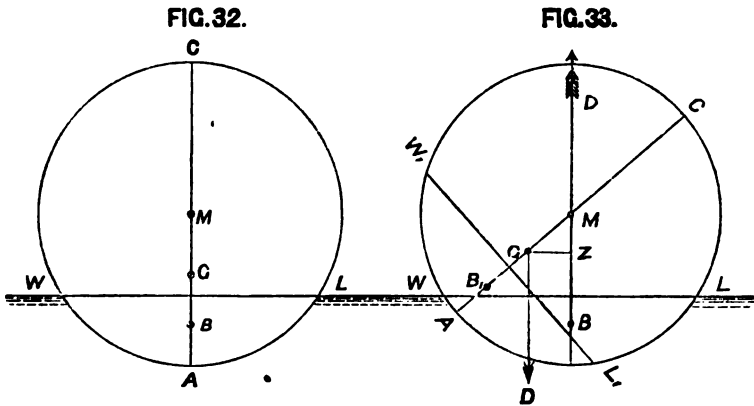
Ships.	Length.	Breadth Extreme.	Mean Draught.	Metacentric Height(GM).
	Feet ins.	Feet ins.	Feet ins.	Feet
<i>Warrior</i>	380 0	58 4	26 5½	4·7
<i>Minotaur</i>	400 0	59 5	26 8½	3·9

The practical deduction from all these cases is therefore that careful consideration is needed both of the effect of changes in form and proportions upon the position of the metacentre, and of changes in structural arrangements or distribution of weights upon the position of the centre of gravity, in order to arrive at a correct estimate of the probable metacentric height—measuring the “stiffness”—of a ship.

Summing up the foregoing remarks on the metacentric method of estimating stability, it may again be stated that the metacentre is simply a fixed point through which the buoyancy of a ship may be supposed to act for all angles of inclination up to 10 degrees or 15 degrees in vessels of ordinary form. This is tantamount to saying that the metacentre may be taken as a hypothetical point of suspension for a ship in order to estimate the righting moment when she is steadily heeled to any angle within the limits named. If the centre of gravity of the ship lies *below* the metacentre, she tends to return towards the upright when inclined a little from it; that is, her equilibrium is *stable*. If the centre of gravity of the ship lies *above* the metacentre, she tends to move away from the upright when slightly inclined; that is, her equilibrium is *unstable*. If the centre of gravity coincides with the metacentre, and the ship is inclined through a small angle, she will have no tendency to move on either side of the inclined position, and her equilibrium is *indifferent*. The metacentre, therefore, measures the height to which the centre of gravity may be raised, without rendering the vessel unstable when upright; and it was this property which led Bouguer, the great French writer to whom we owe the first investigations on this subject, to give the name, metacentre, to the point.

For vessels of unusual form—as, for example, the monitor type with extremely low freeboard—the metacentric method cannot be trusted for such considerable inclination as in ordinary types. On the other hand, there are certain forms for which the metacentric method applies to even greater inclinations, or even for all possible inclinations. The

well-known cigar-ships exemplify the last-named condition. All transverse sections of these ships are circles. Suppose Fig. 32 to represent the section containing the centre of buoyancy B for the upright position, WL being the water-line. Then obviously for any inclined position (such as is shown in Fig. 33, where the original water-line is marked W_1L_1 , and the original centre of buoyancy B_1) the new centre of buoyancy B determines the vertical line of action (BM) of the buoyancy, which intersects the original vertical (B_1M) in the centre (M) of the



cross-section. Hence, if G be the centre of gravity, we shall have for any angle of inclination α ,

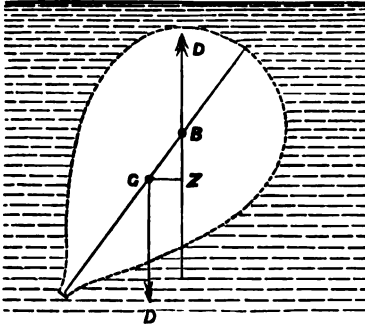
$$\text{Moment of statical stability} = D \times GM \sin \alpha.$$

In other words, the cigar-ship may be regarded as a pendulum turning about the point of suspension M throughout its transverse inclinations, instead of limiting that comparison to 15 degrees, as is done for ordinary ships.

The conditions of stability of a wholly submerged or submarine vessel are as simple as those of the cigar-ship. In Fig. 34 a cross-section of such a vessel is given; B is the centre of buoyancy, and for a position of equilibrium B and the centre of gravity G must lie in the same vertical line. When this condition is unfulfilled (as in the diagram),

the weight and the buoyancy form a mechanical couple, just as in the case of a ship having a part of her volume above water. For the submarine vessel, however, inclination produces

FIG. 34



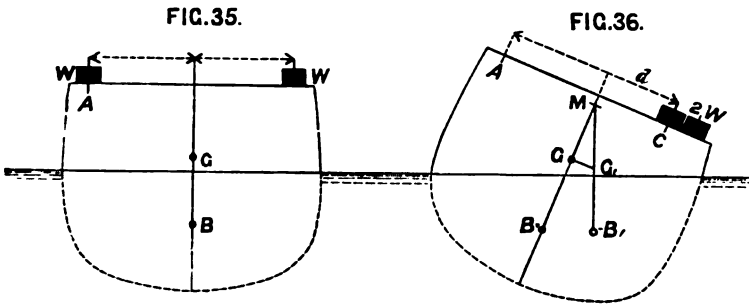
no change in either the form of the displacement or the position of the centre of buoyancy; for all positions the buoyancy acts upwards through the same point B, and the total weight downwards through the centre of gravity G. Consequently stable equilibrium is only possible when the centre of gravity lies (as in the

diagram) below the centre of buoyancy; for obviously, if G were placed vertically above B, and the vessel were inclined ever so little, no position of rest could be reached until G was placed vertically below B. For wholly submerged vessels, therefore, the centre of buoyancy takes the place of the metacentre in vessels partially immersed, and for all angles of inclination (such as α),

$$\text{Moment of statical stability} = D \times BG \sin \alpha.$$

For a given water-line, it is possible to calculate from the drawings of a ship the corresponding displacement, as well as the positions of the centre of buoyancy and metacentre. Direct calculation also enables the naval architect to predict within very narrow limits the position of the centre of gravity, and it is in this manner that any desired metacentric height is secured. But the calculation for the centre of gravity is very lengthy and laborious; and when a ship of the Royal Navy is completed, especially if she be of a new type, it is usually considered desirable to ascertain the exact position of the centre of gravity by means of an *inclining experiment*, which is conducted in the following manner.

The ship being practically complete—with spars on-end, the bilges dry, the boilers empty, no water in the interior free to shift, and all weights on board well secured so that they may not fetch away when she is inclined—is allowed to come to rest in still water. A calm day is desirable, but if there be any wind, the ship should be placed head or stern to it and allowed to swing free, the cables being so led that they may practically have no effect in resisting the inclination of the ship. For the purpose of producing inclination, piles of ballast are usually placed on the deck (see *W, W*, Fig. 35), being at first equally distributed on either side,



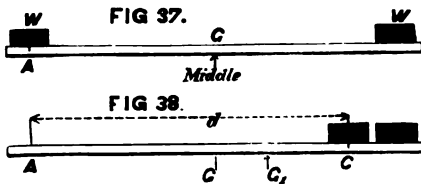
but in some cases the guns of a ship have been traversed from side to side instead of using ballast. Two or three long plumb-lines are hung in the hatchways, and by means of these lines the inclinations from the upright are noted. All being ready, and the ship at rest, the positions of the plumb-lines are marked, and the draught of water is taken. The position of the metacentre corresponding to this draught can then be ascertained by calculation from the drawings. Next a known weight of ballast (*W*, Fig. 35) is moved across the deck through a known distance. The vessel becomes inclined, and after a short time rests almost steadily in this new position, in other words, is once more in *equilibrium*, as shown in Fig. 36. Consequently, for this new position, the metacentre *M* must be vertically above the new centre of gravity (*G₁*); for obviously the shift of ballast has

moved the centre of gravity of the whole ship through a certain distance GG_1 parallel to the deck, and it is this movement of the centre of gravity that produces the inclination. Suppose α to be the angle of inclination noted on the plumb-lines when the ballast W has been moved through the transverse distance d . Then (since GG_1 is perpendicular to GM) we have,

$$GG_1 = GM \tan \alpha; \text{ or } GM = GG_1 \cot \alpha.$$

And if GG can be determined, the distance of the centre of gravity below the known position of the metacentre can be found, and the true vertical position of the centre of gravity is ascertained for the experimental condition of the ship. Any subsequent corrections consequent on the removal of the ballast, addition of water in the boilers, or other alterations in the condition of the ship when fully equipped, can be easily made.

The value of GG_1 can be readily estimated by means of a simple calculation, the character of which may be better



seen by means of an illustration. A uniform lever (Fig. 37) is loaded with two weights, W , placed at equal distances from the middle; it will

then balance upon a support placed at the middle (G) of the length. Now let one of the weights W be moved to the opposite end (as in Fig. 38) through a distance d . Obviously the point about which the lever will balance (that is, the *centre of gravity* of the lever and the weights W) will no longer be at the middle, but at some point (G_1 , Fig. 38) to the right of the middle. If D be the total weight of the lever and the weights it carries, by the simplest mechanical principle it follows that

$$D \times GG_1 = W \cdot d; \text{ whence } GG_1 = \frac{W \cdot d}{D}.$$

What is true in this simple case is true also for the ship; the line GG_1 , in Fig. 36, joining the old and new positions of the centre of gravity, must be parallel to the deck-line, across which the weight W is moved, and the above expression for GG_1 holds. Hence, since

$$GM = GG_1 \cdot \cot a, \text{ while } GG_1 = \frac{W \cdot d}{D},$$

it follows that

$$GM = \frac{W}{D} \cdot d \cot a,$$

an equation fully determining the position of the centre of gravity G in relation to the known vertical position of the metacentre M , ascertained by calculation from the drawings.

As an example, suppose a ship for which the displacement (D) is 4000 tons to have 60 tons of ballast placed upon her deck, 30 tons on each side. When the 30 tons (W) on the port side is moved to starboard through a transverse distance of 40 feet (d), the vessel is observed to rest at a steady heel of 7 degrees from her original position of rest. Then, from the above expression—

$$\begin{aligned} GM &= \frac{W}{D} \cdot d \cot a = \frac{30}{4000} \times 40 \times \cot 7^\circ \\ &= \frac{3}{10} \times 8.144 = 2.43 \text{ feet.} \end{aligned}$$

In practice it is usual to subdivide the ballast on each side into two equal piles, and to make four observations of the inclinations produced by—

- (1) Moving one pile of ballast from port to starboard;
- (2) Moving second pile of ballast from port to starboard.

These two piles having been restored to their original places, the plumb-lines should return to their first positions, unless some weights other than the ballast have shifted during the inclinations. Then two other inclinations are produced and noted by—

- (3) Moving one pile of ballast from starboard to port;
- (4) Moving second pile of ballast from starboard to port.

The results of observations (1) and (3), (2) and (4), should

agree respectively if the four piles of ballast are of equal weight, and if the distance d is the same for all; the inclinations in (2) and (4) should be about twice those in (1) and (3). The values of GM are deduced from each experiment and the *mean* of the values is taken as the true value of the metacentric height at the time of the experiment. Then it is easy to deduce the metacentric height for the vessel in her fully equipped sea-going condition, or in any other assigned condition.

The reason for great caution in preventing any motion of weights on board, other than the ballast, during the inclining experiment will appear from the expression given above for the motion (GG_1) of the centre of gravity. The moment due to the motion of the ballast Wd is comparatively small; in the above example, which is a fair one,

$$Wd = 30 \text{ tons} \times 40 \text{ feet} = 1200 \text{ foot-tons,}$$

and

$$GG_1 = \frac{1200}{4000} = \frac{3}{10} \text{ foot only.}$$

Now, if other weights, and particularly free water in the bilges, shift as the ship inclines, their aggregate moment may bear a considerable proportion to $W \cdot d$, and so the estimated value of GG_1 may be less than the true one. For example, 5 tons of water free to shift 30 feet in a transverse direction would have a moment (5×30) of 150 foot-tons, or no less than *one-eighth* that of the ballast, and if its effect were unobserved through carelessness, the motion of the ballast would be credited with producing an inclination about *one-eighth greater* than it could produce acting alone. In the foregoing example, if such an error had been made, instead of writing $Wd = 1200$ foot-tons, it should have been $1200 + 150 = 1350$ foot-tons; so that the metacentric height would have been—

$$GM = \frac{1350}{4000} \times \cot 7^\circ = \frac{27}{80} \times 8.14 = 2.75 \text{ feet.}$$

In performing inclining experiments, too great care cannot

therefore, be taken to ensure that no other weights shall shift than those made use of to produce the inclinations.

The preceding illustration also serves to indicate how the statical stability of a ship is decreased by the presence of free water in her hold. If the skin of the ship is intact, the water in the hold may be treated as a load carried in her bilges, and its motion towards the side to which the ship may be steadily heeled will be equivalent to a shift of the centre of gravity in that direction, and to a consequent decrease in the stability. When "shifting cargoes," such as grain, are carried, there is a similar tendency to produce a motion of the centre of gravity towards the leeward side, especially if the ship is steadily heeled under sail for a considerable time, as she might be in the region of the trade winds. In such cases, if the inclining forces were removed, the ship would obviously not return to the upright, but rest in an inclined position, determined by the consideration that the corresponding centre of buoyancy shall be in the same vertical line with the shifted position of the centre of gravity. At present we are concerned only with these statical conditions; but free water in the hold of a ship rolling in a seaway is much more likely to cause danger.

Damage to the bottom of a ship may be so serious as to admit large quantities of water into the hold, and to leave them in *free communication* with the water outside. This condition of things as a possible cause of foundering has already been discussed at length;* it is therefore only necessary to refer to the effect upon the statical stability of a ship having a bilged compartment. Except in the few cases where watertight decks or platforms form tops to compartments, it may be said that the bilged compartment ceases to contribute any buoyant water-line area. In fact, taking the box-shaped vessel in Fig. 11 (page 19) as an example, the effect of filling the compartment is to reduce

* See Chapter I. pages 12-14.

the original water-line area by the area (fg) of the top of the compartment. Now it has been explained above that the vertical position of the metacentre in relation to the centre of buoyancy depends upon the form and area of the buoyant water-line, or plane of flotation; any decrease therefore in area must be accompanied by a consequent decrease in the height of the metacentre above the centre of buoyancy. But, on the other hand, the deeper immersion of the ship, when the compartment is bilged, leads to a rise in the position of the centre of buoyancy in the ship. The difference between this fall of the metacentre and rise of the centre of buoyancy measures the alteration in the metacentric height; and, for angles up to 10 or 15 degrees in ships of ordinary form, will give a fair measure of the change of stiffness produced by filling the compartment. In some cases (and almost invariably where a midship compartment is damaged) the stability is decreased; in others it is increased. Without an investigation it is frequently not easy to determine the true character of the change. The difference between this case and that where water in the hold is not in free communication with the water outside lies principally in the fact that with a damaged bottom, if there be no horizontal watertight partition above the level of the hole, the water in the bilged compartment always maintains the same level as that of the water outside when the ship is held steadily in any position. Having, therefore, determined by this condition how much water will enter the damaged compartment, if we then conceive the bottom to be made good, and the compartment to contain that quantity of water, the statical stability of the ship may be estimated at any angle of inclination to which the metacentric method applies in the same manner as was explained above for a vessel having free water in the hold and the bottom intact.

When other than statical conditions come into operation, as, for instance, when a ship is rolling rapidly in a seaway, it is important to distinguish between the cases of free water contained within an undamaged skin and of water admitted

to the interior by fracture of the bottom. And, further, it is necessary to distinguish between the cases of serious and slight damage to the bottom when dealing with the ship in motion, whereas no such distinction is necessary in discussing the stability for a steady heel. When held at a steady heel, free water in the hold will adjust its surface horizontally, even if there be some obstruction to the motion of the water towards this position of rest; but if the ship is in motion and changing her position rapidly, the element of time has to be considered, and the free water contained within an undamaged skin may not move rapidly enough as compared with the motions of the ship to maintain the horizontality of its surface. Similarly, when the ship is held at a steady heel, it does not make any difference whether a hole in the bottom of a bilged compartment is large or small; the final result will be that the compartment will be filled up to the level of the water outside. But the time taken in filling the compartment, or allowing any quantity of water to pass through the hole, of course depends upon the size and situation of the hole in the bottom; and therefore, when a ship is in motion, and the volume of any compartment up to the level of the water outside may be constantly changing, there is a marked difference between the stability in the cases of slight and serious damage. In the latter it may be assumed that the level of the water in the compartment remains coincident with that of the water outside throughout the motion; but with a small hole in the bottom this will not be true.

It will be only necessary to refer once more to Figs. 15-17 (pages 27, 28) in order to illustrate the beneficial effect upon the statical stability of horizontal watertight platforms. When the compartment above the flat pq in Fig. 17 is filled, the stiffness of the box-shaped vessel is *less* than before the damage occurred; owing to the loss in buoyant water-line area bringing down the metacentre more than is compensated for by the rise in the centre of buoyancy. When the compartment below the flat pq in Fig. 16 is filled, there is no loss of buoyant water-line area, and consequently no fall in the

metacentre relatively to the centre of buoyancy, while the latter point rises, owing to the deeper immersion, the final result being an *increase* in stiffness as compared with the undamaged vessel.

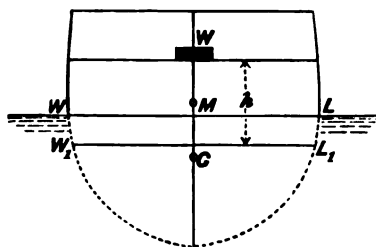
Longitudinal bulkheads, such as are shown in Fig. 14, page 26, are very valuable aids to the maintenance of transverse stability when there is free water in the hold, by limiting the transverse shift of that water as the vessel becomes inclined, as well as by limiting the quantity of water admitted by damage to the bottom. When ships are rolling, the advantage of such bulkheads is still greater than when they are steadily heeled, as the bulkheads prevent the wash of water from side to side, which is a necessary accompaniment of rolling in a ship with no similar obstructions to the motion of the water.

Double-bottom compartments (such as those described in Figs. 20–25, page 30) are commonly used for water ballast. The spaces below the watertight longitudinals (*a*, Figs. 21–25) at the bilges are generally employed for this purpose, arrangements being made for readily filling or emptying these spaces. It is most important that the compartments used for water ballast should be *quite full*; otherwise, some motion, and consequently a decreased stability, will result as the ship becomes inclined. When so filled, the weight of water ballast in the compartments may be treated as if

it were solid ballast, not capable of any shift, in estimating the change in the stability produced by its addition.

A ready rule for estimating the change in the metacentric stability or stiffness of a ship produced by adding or removing weights, of which the vertical positions are known, will be useful. Suppose Fig. 39

FIG 39.



vertical positions are known, will be useful. Suppose Fig. 39

to represent a case where weights amounting in the aggregate to W tons have been put on board a ship, with their centre of gravity h feet above the water-line (W_1L_1) at which the ship floated before the weights were added. Let G be the original position of the centre of gravity of the vessel, and M the metacentre corresponding to the water-line W_1L_1 ; then, if D be her displacement to that line, her stability for some angle a within the limits to which the metacentric method applies will have been

$$\text{Moment of statical stability} = D \times GM \sin a.$$

The addition of the weights W will increase the immersion of the ship by a certain amount, which can be estimated by the method of "tons per inch" explained in Chapter I. It may be assumed, however, that commonly the weights added are comparatively so small that their addition will only immerse the vessel a few inches; and consequently the centre of gravity of those weights may be fixed relatively to the original water-line W_1L_1 .* Their moment about W_1L_1 will be $= W \times h$ foot-tons; and then the expression for the statical stability at the angle a will become altered by the addition of the weights to

$$\text{I. Moment of statical stability} = (D \times GM - W \times h) \sin a.$$

Had the weights W been placed with their centre of gravity at a distance h below W_1L_1 , the stability would have been *increased* by the amount $Wh \sin a$, and

$$\text{II. Moment of statical stability} = (D \times GM + W \times h) \sin a.$$

Conversely, if weights are removed from *above* the water-line W_1L_1 (say, W tons at a height h feet), the stability of a ship is *increased* by the change, and for an angle a

$$\text{III. Moment of statical stability} = (D \times GM + W \times h) \sin a.$$

* Strictly speaking, the distance h should be measured in most cases, not from the water-line W_1L_1 , but from the centre of gravity of the

zone of displacement lying between that water-line and WL. In some cases, h should be measured from the metacentre.

Whereas, if the same weights are removed from an equal distance *below* WL, the stability is *decreased*; and

IV. Moment of statical stability = $(D \times GM - W \times h) \sin a$.

As an example, suppose a ship of 6000 tons displacement, with a metacentric height (GM) of $3\frac{1}{2}$ feet, to have additional guns, weighing 50 tons, placed on her upper deck, their common centre of gravity being 18 feet above water. Rule I. applies, and we have, for an angle a ,

$$\begin{aligned} \left. \begin{array}{l} \text{Original moment of statical} \\ \text{stability} \end{array} \right\} &= 6000 \text{ tons} \times 3\frac{1}{2} \text{ feet} \times \sin a \\ &= 19,500 \text{ (foot-tons)} \times \sin a. \\ \left. \begin{array}{l} \text{Moment of statical stability} \\ \text{after the addition of the} \\ \text{weights} \end{array} \right\} &= (19,500 - 50 \times 18) \sin a \\ &= 18,600 \text{ (foot-tons)} \times \sin a. \end{aligned}$$

Suppose the same ship to have 100 tons of water ballast added, instead of the guns, the centre of gravity of the ballast being 16 feet below the water-line. Then Rule II. applies, and the stability is increased, becoming for angle a

$$\left. \begin{array}{l} \text{Altered moment of statical} \\ \text{stability} \end{array} \right\} = (19,500 + 100 \times 16) \sin a \\ = 21,100 \text{ (foot-tons)} \times \sin a.$$

It is unnecessary to give illustrations of the remaining rules for the removal of weights.

When the vertical positions of weights already on board a ship are changed, the result is simply a change in the position in the centre of gravity of the ship; for obviously the displacement and position of the metacentre remain unaltered, since there is no addition or removal of weights. The shift of the centre of gravity can be readily estimated by the rule already given (on page 78). Suppose the total weight moved to be w , and the distance through which it has been raised or lowered to be h , then, if GG_1 be the rise or fall in the centre of gravity,

$$GG_1 = \frac{w \cdot h}{D},$$

where D is the total displacement of the ship. If GM was the original height of the metacentre above the centre of gravity, for an angle a within the limits to which the metacentric method applies,

Original moment of statical stability = $D \times GM \times \sin a$.

Altered moment of statical stability = $D (GM \pm GG_1) \sin a$.

The alteration is an increase when the weights are lowered ; a decrease when the weights are raised. As an example, take the ship previously used ; and suppose spars, &c., weighing together 10 tons, to be lowered 70 feet. Then

$$GG_1 \text{ (fall of centre of gravity)} = \frac{10 \times 70}{6000} = \frac{7}{60} \text{ foot.}$$

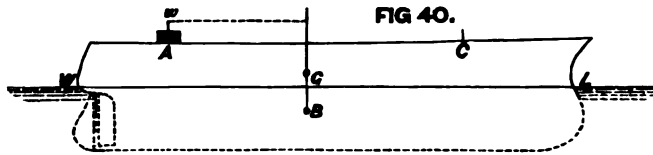
$$\left. \begin{array}{l} \text{Original moment of statical} \\ \text{stability (as before) . . .} \end{array} \right\} = 19,500 \text{ foot-tons} \times \sin a.$$

$$\left. \begin{array}{l} \text{Altered moment of statical} \\ \text{stability} \end{array} \right\} = 6000 \left(3\frac{1}{4} + \frac{7}{60} \right) \sin a \\ = 20,200 \text{ foot-tons} \times \sin a.$$

These constitute the most important practical applications of the metacentric method to the stability of ships inclined transversely. Attention must next be turned to longitudinal inclinations, or changes of trim.

The process by which the naval architect estimates *changes of trim* produced by moving weights already on board a ship is identical in principle with the inclining experiment described above ; only in this case he makes use of a metacentre for longitudinal inclinations (or, as it is usually termed, the "longitudinal metacentre"), instead of the transverse metacentre with which we have hitherto been concerned. The definition of the metacentre already given for transverse inclinations is, in fact, quite as applicable to inclinations in any other direction, longitudinal or skew ; but it has already been explained that, as the transverse stability of a ship is her minimum, while the longitudinal stability is her maximum, only these two need be considered.

The contrast between transverse and longitudinal stability cannot be better shown than by the statement that, whereas the "metacentric height" for transverse inclinations varies from 2 to 14 feet, the corresponding height for longitudinal inclinations usually approximates to equality with the *length of the ship*, in some classes exceeding it by 20 or 25 per cent., and in others falling below the length by 10 or 15 per cent. The *Warrior*, for example, has a longitudinal metacentric height of about 475 feet against a transverse metacentric height of 4.7 feet. To incline her 10 degrees longitudinally would require a moment one hundred times as great as would produce an equal inclination transversely. Or, to state the contrast differently, the moment which would hold the ship to a steady heel of 10 degrees would only incline her longitudinally about $\frac{1}{10}$ degree, equivalent to a change of trim of 6 or 8 inches on a length of 380 feet.

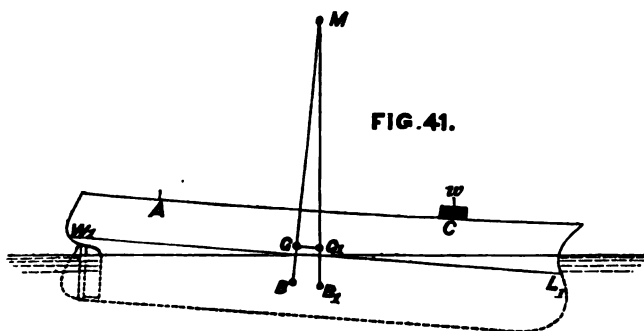


In Figs. 40, 41, are given illustrations of the change of trim produced by moving weights already on board a ship; but, before proceeding further, it may be well to repeat the explanation given in an earlier chapter of the term "change of trim." The *difference of the draughts* of water forward and aft (which commonly takes the form of excess in the draught aft) is termed the trim of the ship. For instance, a ship drawing 23 feet forward and 26 feet aft is said to trim 3 feet by the stern. Suppose her trim to be altered, so that she draws 24 feet forward and 25 feet aft, the "change of trim" would be 2 feet, because she would then trim only one foot by the stern. In short, "change of trim" expresses the sum of the increase in draught at one end and decrease in draught at the other; so that,

if the vessel be inclined longitudinally through an angle a , and L be her length,

$$\text{Change of trim} = L \times \tan a.$$

Suppose the height of the longitudinal metacentre above the centre of gravity to be GM , as in Fig. 41, then, when the weight w is shifted longitudinally along the deck from A to C through a distance d , we shall have, by similar rea-



soning to that given in the case of the inclining experiment, the centre of gravity moving parallel to the deck, and

$$\text{Shift of centre of gravity } (GG_1) = \frac{w \cdot d}{D};$$

also

$$GG_1 = GM \tan a = \frac{w \cdot d}{D}; \text{ whence } \tan a = \frac{w \cdot d}{D \times GM};$$

and from the above expression, .

$$\text{Change of trim} = L \times \tan a = \frac{w \cdot d}{D} \times \frac{L}{GM}.$$

Take the case of the *Warrior*, for which, at a draught of $25\frac{1}{2}$ feet, length = $L = 380$ feet; metacentric height = $GM = 475$ feet; displacement = 8625 tons. Suppose a weight (w) of 20 tons to be shifted longitudinally 100 feet,

$$\text{Change of trim} = \frac{20 \times 100}{8625} \times \frac{380}{475} = \cdot 186 \text{ foot} = 2\frac{1}{4} \text{ inches.}$$

It is usual to obtain for a ship the value of the "moment

to change the trim one inch," when floating at the loss draught; and then for changes of trim up to 2 or 3 feet no great error is involved in assuming that for a change of trim of any number of inches the moment required will be equal that number of times the moment which will change the trim one inch. Substituting in the equation,

$$\text{Change of trim} = \frac{w \cdot d}{D} \times \frac{L}{GM},$$

one inch as change of trim (i.e. $\frac{1}{12}$ foot), we have,

$$\frac{1}{12} = \frac{w \cdot d}{D} \times \frac{L}{GM} : \text{whence } w \cdot d = \frac{D}{12} \times \frac{GM}{L}.$$

Here $w \cdot d$ = moment to change trim one inch; and since the height, GM, approaches to equality with the length, in vessels of moderate proportions and fineness, the following rule holds with a fair degree of approximation: "The moment to change the trim of a ship one inch—this is, the product of the weight moved by the longitudinal distance it is shifted—will very nearly equal (in foot-tons) one-twelfth of the ship's displacement (in tons)." In long fine vessels like the *Warrior*, this rule will give results rather below the truth, because GM is greater than L, whereas in short full ships its results will be rather in excess, because GM is less than L. In the *Warrior*, for example, where the metacentric height is proportionately great, $\frac{1}{12} \times D = 718$; whereas the moment to change trim one inch is 898 foot-tons. In the *Hotspur*, on the contrary, $\frac{1}{12} \times D = 334$; whereas the moment to change trim is 400 foot-tons, the metacentric height in this case being 211 feet and the length 235 feet.

The conditions are rather more complicated when weights are to be added to a ship, being placed with their centre of gravity in a certain known position, and it is required to determine the resultant draughts of water at the bow and stern. A good approximation may, however, be made by the following, supposing that the weights added are small with

compared with the total weight of the ship—a supposition which will be fair in most cases. First, suppose the weights to be placed on board directly over the centre of gravity of the load-line section of the ship; then the vessel will sink bodily without change of trim, until she reaches a draught giving an addition to the displacement equal to the weights added. This can be estimated by the method of tons per inch immersion previously explained. The centre of gravity of the load-line section, or plane of flotation, usually lies a few feet abaft the middle of the length of the ship at the water-line, say, from one-thirtieth to one fiftieth of the length abaft the middle. Having supposed the weights concentrated over this point, the next step is to distribute them, moving each to its desired position; each weight is multiplied by the distance it would have to be moved either forward or aft, and the respective sums of the products forward and aft being obtained, their difference is ascertained, this difference constituting the “moment to change trim.” The final step is to estimate the resultant change of trim due to this moment by the metacentric method previously explained. For example, take the *Warrior*, and suppose the following weights to be placed on board :—

Weight.	Distance from Centre of Gravity of Plane of Flotation.	Products.	
		Before.	Abaft.
Tons.	Feet.		
10	140	1400	..
30	120	3600	..
20	40	800	..
40	5	200	..
60	8	..	480
50	60	..	3000
25	100	..	2500
15	120	..	1800
250	..	6000	7780 6000
Moment to change trim (by the stern)			1780

Moment to change trim one inch (say) = 890 foot-tons ;

$$\therefore \text{Change of trim} = \frac{1780}{890} = 2 \text{ inches ;}$$

$$\left. \begin{array}{l} \text{Increase in mean} \\ \text{draught . . .} \end{array} \right\} = \frac{\text{Weights added}}{\text{Tons per inch}} = \frac{250}{41} = 6 \text{ inches.}$$

If the original draught of water was 25 feet forward, and 26 feet aft, mean $25\frac{1}{2}$ feet, the altered mean draught will be 26 feet, and the corresponding draught forward will be about 25 feet 5 inches and aft 26 feet 7 inches.*

A vessel partially water-borne and partly aground loses stability as compared with her condition when afloat. One of the commonest illustrations of this fact is found in the case of boats run bow-on to a shelving beach ; and instances are on record where vessels in dock have been upset, in consequence of a similar loss of stability,† when just taking the blocks, and not supported by side-shores, while the water was being admitted to or pumped out of the docks. For our present purpose it will suffice to indicate in general terms the conditions influencing the loss of stability. When afloat, the ship is wholly supported by the buoyancy due to the water she displaces ; when her keel touches the blocks or ground, she is partly supported by the upward pressure at that point, the remainder of her weight being supported by the water then displaced, which is by supposition less than the total displacement due to her weight. Having given the height to

* To be exact, the alterations in draught forward and aft should be proportioned to the distances of the centre of gravity of the water-line plane from bow and stern.

† A well known case is that of her Majesty's troopship *Perseverance*, which fell over on her side when being undocked at Woolwich some years ago. The matter was fully investigated at the time by

Mr. Barnes (now Surveyor of Dockyards at the Admiralty), and he has since contributed an article on the same subject to the *Annual of the Royal School of Naval Architecture* (see page 85 of No. 4). To this article, readers desirous of fully understanding the mathematical treatment of the case may turn with advantage.

which the water rises on the ship at any instant, it is easy to estimate the corresponding buoyancy; then the difference between it and the weight of the ship measures the pressure at the point of contact, and corresponds to the buoyancy contributed by the volume of the ship lying between her load-line when afloat and the actual water-line at the time she is partly water-borne. What has really been done, therefore, is to transfer the buoyancy of this zone (acting through the centre of gravity of the zone) down to the point of contact of the keel with the ground. And when the vessel is inclined through a small angle from the upright, this pressure actually tends to upset her, whereas the buoyancy it has replaced would usually tend to right her. Hence the decreased stability.

It is possible to obtain a ready rule for estimating the loss. Suppose—

- P = pressure of end of keel on ground;
- h = height of centre of gravity of the aforesaid zone above the point of contact of the keel and ground;
- W = total weight of ship.

Then mathematical investigation shows that—

$$\left. \begin{array}{l} \text{Loss of metacentric height (GM) due to partial} \\ \text{grounding} \end{array} \right\} = \frac{Ph}{W}.$$

Take as an example the case of the *Perseverance*. Mr. Barnes estimates that the degradation of the metacentre in that case was about 6 inches. The data were:—P = 51 tons; W = 1303 tons; h = 13 feet.

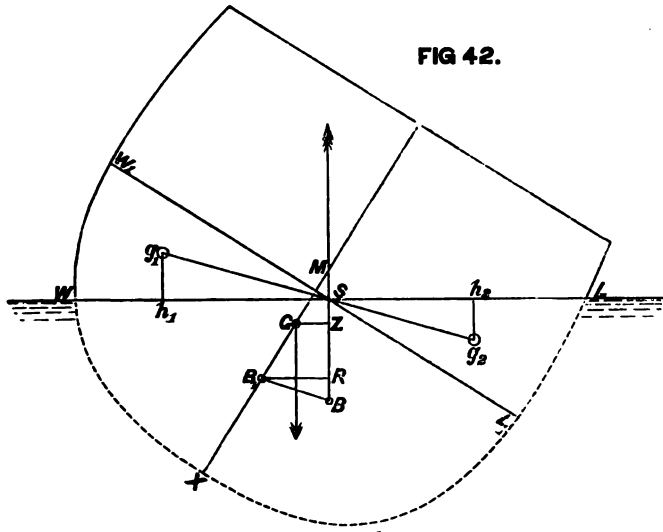
$$\therefore \text{Loss of metacentric height} = \frac{51 \times 13}{1303} = 6 \text{ inches (about).}$$

Vessels having a very considerable normal trim by the stern are most liable to this kind of accident, and the upsetting tendency due to the pressure reaches its maximum when the vessel is about to take the ground along the whole length of the keel. The practical method of guarding against such accidents of course consists in carefully shoring

or otherwise supporting the vessel externally, in order to prevent her from upsetting.

Up to this point attention has been directed exclusively to the stability of ships inclined to angles lying within the limits to which the metacentric method applies. For longitudinal inclinations, except in very special cases, nothing further is required; but for transverse inclinations it is necessary to ascertain the statical stability at greater angles, and to determine the inclination at which the ship becomes unstable. The general principles previously laid down for determining the moment of the couple formed by the weight and buoyancy apply to all angles of inclination; and it is consequently only necessary to fix for any angle the vertical line, passing through the centre of buoyancy, along which the resultant upward pressure of the water acts. This is done by calculation from the drawings of a ship, and involves considerable labour; but the principle upon which it is based may be simply explained. Fig. 42 shows the cross-section of a ship which, when upright, floated at the water-line W_1L_1 , having the volume of displacement indicated by W_1XL_1 , and the centre of buoyancy B_1 . When inclined as in the diagram, WL is the water-line, WXL the volume of displacement, and B the corresponding centre of buoyancy. Since the displacement remains constant, the volumes WXL and W_1XL_1 are equal, and they have the common part WSL_1XW . Deducting this common part, the remainder (W_1SW) of the volume W_1XL_1 must equal the remainder (LSL_1) of the volume WXL ; or, as it is usually stated, the *wedge of immersion* LSL_1 must equal the *wedge of emersion* W_1SW . In other words, the inclination of the vessel has produced a change in the form of the displacement equivalent to a transfer of the wedge WSW_1 to the equal, but differently shaped, wedge LSL_1 . This is obviously a parallel case to that of the lever explained on page 78. In Fig. 42, let g_1 be the centre of gravity of the wedge of emersion, g_2 that of the wedge of

immersion, and v the volume of either wedge; then what has been done is equivalent to a transfer of this volume v to the immersed side, into the position having g_2 for its centre of gravity. The moment due to this shift $= v \times g_1g_2$; and its consequence is a motion of the centre of gravity of the total volume of displacement V from the original position, B_1 , to the new one, B , the line B_1B being parallel to g_1g_2 , and the length $BB_1 = \frac{v}{V} \times g_1g_2$.



It thus becomes obvious that, when the positions of the centres of gravity of the wedges (g_1 and g_2) for any inclination are known, the new position of the centre of buoyancy (B) can be determined with reference to its known position (B_1) when the ship is upright. And this is virtually the process adopted in the calculation. If B_1R be drawn perpendicular to BM , Fig. 42, and g_1h_1 , g_2h_2 perpendicular to WL , then, by the same principle as is used above, the length $B_1R = \frac{v}{V} \times h_1h_2$.

Also, if the angle of inclination WSW_1 be called α ,

$$GZ = B_1R - B_1G \sin \alpha,$$

and, consequently,

$$\begin{aligned} \text{Moment of statical stability} &= V \times GZ = V(B_1R - B_1G \sin \alpha) \\ &= v \times h_1 h_2 - V \times B_1G \sin \alpha. \end{aligned}$$

This expression for the righting moment (in terms of the volume of displacement) is known as "Atwood's formula," and is commonly employed in constructing "curves of stability."

FIG. 43.

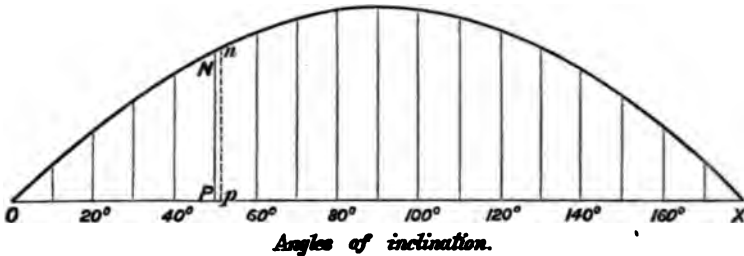


Fig. 43 shows the method of construction for such a curve. On the base line OPX degrees of inclination are set off on a certain scale, O corresponding to the upright; the ordinate of the curve drawn perpendicular to the base-line at any point measures, on a certain scale, the "arm of the righting couple" (GZ) for the corresponding angle of inclination. Thus, OP represents an inclination of 50 degrees; and the corresponding ordinate PN represents the length of the arm of the couple formed by the weight and buoyancy at that inclination. By calculation successive values of GZ are found for inclinations differing by an interval of 8 or 10 degrees; and the curve is drawn through the tops of the ordinates thus found. Measurement of the ordinates renders any calculation unnecessary for inclinations other than those made use of in drawing the curve. It will be observed that, starting from the upright position,

the stability gradually increases, reaches a maximum value, and then decreases, finally reaching a zero value (where the curve crosses the base-line) at the inclination where the ship becomes unstable. The preceding explanation of the causes governing the position of the centre of buoyancy will furnish the reason for this gradual increase and after decrease in the stability. The length (OX) measuring the inclination at which the ship becomes unstable determines what is known as the *range* of stability for the ship, and this is an important element of safety.

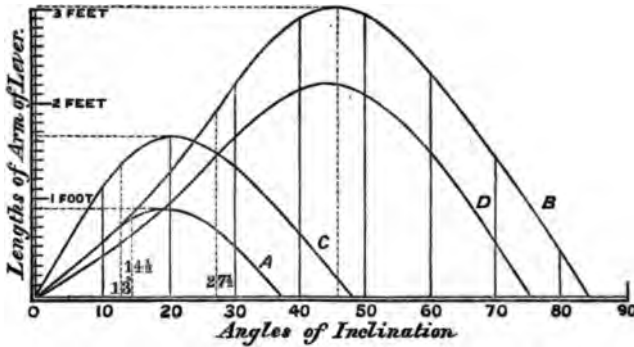
One of the simplest illustrations of a curve of stability is that for the cigar-ship shown in section by Figs. 32, 33, page 75. In such vessels, as previously explained, for any angle α , $GZ = GM \sin \alpha$, and the curve of stability is constructed by simply setting up, at any point on the base-line, a length representing the sine of the angle of inclination corresponding to that point. Fig. 43 shows this curve. The range is 180 degrees; the maximum stability is reached at 90 degrees, and the curve is symmetrical about its middle ordinate. Variations in the values of the metacentric height (GM) affect all the ordinates of the curve in the same proportion.

Ship-shaped forms are less easy to deal with; but a brief explanation of the causes chiefly influencing the form and range of curves of stability in ships will be of value. These causes may be grouped under the following heads:—(1) Freeboard; (2) beam; (3) the vertical position of the centre of gravity. Both freeboard and beam are of course relative measures, and should be compared with the draught of water. Before giving any illustrations of curves of stability for actual ships, a few simple examples may be taken from box-shaped vessels in order to show the relative influence of the above-mentioned features. The following cross-sections will serve the purpose:—

Dimensions.	No. 1.	No. 2.	No. 3.
Beam	50½	50½	57½
Draught	21	21	21
Freeboard	6½	13½	6½
Metacentric height (GM)	2·6	2·6	5

Taking No. 1 as a standard for comparison, its curve of stability is shown by A in Fig. 44. The effect of adding 7 feet to the freeboard—supposing the centre of gravity to be unchanged in position—is seen by comparing the curve of stability B for No. 2 with the curve A.

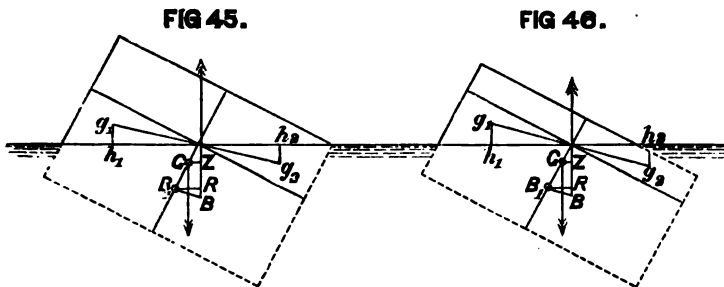
FIG. 44.



Similarly, the effect of adding 7 feet to the beam is seen by comparing the curve of stability C for No. 3 with the other two curves. Only a few further words of explanation will be necessary.

At an inclination of $14\frac{1}{2}$ degrees, the “deck-edge,” or angle, of No. 1 will be immersed; for No. 2 the corresponding inclination is nearly doubly as great, viz. $27\frac{1}{2}$ degrees. Fig. 45 shows No. 2 with its deck-edge “awash.” Fig. 46 shows No. 1 at the same inclination, with a considerable portion of its deck immersed. Up to the inclination when the deck-edge of either vessel is just immersed, the centre of buoyancy B moves steadily outward in relation to the

centre of gravity as the inclination increases, in consequence of the gradual increase in the volume of the wedges of immersion and emersion, and in the distance g_1g_2 between their centres of gravity. But after the deck goes under water, this outward motion of the centre of buoyancy relatively to the centre of gravity becomes slower, or is replaced by a motion of return, in consequence of the decrease in the distance g_1g_2 between the centres of gravity and the less rapid growth



of the volumes of the wedges. The increase in value of the term $B_1G \sin \alpha$ in the formula,

$$V \times GZ = v \times h_1h_2 - V \cdot BG \sin \alpha,$$

also tends to diminish GZ as the inclination increases. The greater the angle of inclination corresponding to the immersion of the deck-edge—in other words, the higher the ratio of freeboard to breadth—the greater will be the inclination at which the statical stability reaches its maximum value. Up to $14\frac{1}{2}$ degrees, the curves A and B in Fig. 44 are identical; but then B continues to rise rapidly, not reaching its maximum until 45 degrees, whereas A reaches its maximum at 20 degrees. The low-freeboard box, moreover, has a range of less than 40 degrees, whereas the high-freeboard box (No. 2) has a range of 84 degrees.

Turning to No. 3 section, and the curve of stability C, it will be noticed that the increase of 7 feet in beam causes a considerable increase in the metacentric height (GM). For moderate inclinations, $GZ = GM \sin \alpha$, and therefore this increase in GM is accompanied by a corresponding

increase in the steepness of the earlier part of the curve of stability C, as compared with the curves A and B in Fig. 44. The deck-edge becomes immersed, however, at 13 degrees, the maximum stability is reached at 20 degrees, and the range of stability is less than 50 degrees as against 84 degrees in curve B for the higher freeboard vessel.* The comparison of these curves will show how much more influential increase of freeboard is than increase of beam in adding to the amount and range of the statical stability of ships.

Lastly, to illustrate the effect of the vertical position of the centre of gravity upon the forms of curves of stability, let it be assumed that the high freeboard vessel (No. 2 section) has its centre of gravity raised one foot, leaving the value of the metacentric height (GM) 1.6 foot. This will be no unfair assumption, seeing that the increase in freeboard, and consequently in total depth, would in practice be associated with a rise in the centre of gravity. The curve of stability D, Fig. 44, corresponds to this last case. For each inclination the decrease in the arm of the righting couple, as compared with curve B, is given by the expression,

$$\text{Decrease in } GZ = GG_1 \times \sin \alpha,$$

where GG_1 (rise in position of centre of gravity) is one foot. Initially the curve D falls within A and B, the vessel being more crank. It has, however, its maximum ordinate at 45 degrees, and a range of 75 degrees, comparing very favourably indeed with the curve C for the low-freeboard vessel with broad beam (No. 3). The reader will have no difficulty in making a more detailed comparison of the curves for these representative vessels, should that be considered desirable.

In concluding this chapter, a few examples will be given of curves of stability for different classes of ships, from which

* A full discussion of this subject will be found in a paper contributed to vol. xii. of the *Transactions* of the Institution of Naval Architects

by Mr. Barnaby, C.B., Director of Naval Construction. Some of the preceding illustrations are borrowed from this paper.

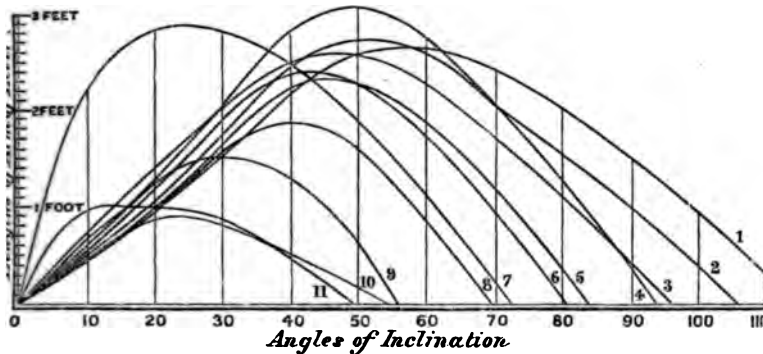
it will be seen that the foregoing deductions from prismatic bodies apply also to ships. The following table gives the principal dimensions, &c. of these representative vessels :—

Name.	Class of Ship.	Length.	Breadth Extreme.	Mean Draught.	Height of Upper Deck Amidships above Water.	Displacement.
<i>Unarmoured.</i>						
<i>Endymion</i> . . .	Old type steam frigate . . .	Feet. 240	Feet ins. 47 10	Feet ins. 20 6	Feet ins. 14 8	Tons. 3300
<i>Juno</i> . . .	Covered-deck corvette . . .	200	40 0	17 4	14 6	2215
<i>Inconstant</i> . . .	Swift cruising frigate . . .	337	50 3½	23 10½	15 3½	5782
<i>Serapis</i> . . .	Indian troopship . . .	360	49 0	19 5	15 0	5976
<i>Armoured.</i>						
<i>Glutton</i> . . .	Breastwork monitor . . .	245	54 0	18 9	3 0	4912
<i>Miantonomoh</i> . . .	American monitor . . .	250	52 10	14 0	3 0	3842
<i>Captain</i> (late) . . .	Low-freeboard } turret-ships {	320	53 3	25 0½	6 6	7790
<i>Monarch</i> . . .	High-freeboard } turret-ships {	330	57 6	24 1½	14 0	8215
<i>Devastation</i> . . .	Mastless } turret-ships {	285	62 3	26 1½	11 3*	9061
<i>Achilles</i> . . .	Early type } broadside-ships {	380	58 3½	26 5	15 0	9484
<i>Invincible</i> . . .	Later type } broadside-ships {	280	54 0	22 6	16 0	6060

* Only 4½ feet aft.

In Fig. 47 the respective curves of stability for these

FIG. 47.



- | | |
|-----------------------|------------------------|
| 1. <i>Juno.</i> | 7. <i>Miantonomoh.</i> |
| 2. <i>Inconstant.</i> | 8. <i>Monarch.</i> |
| 3. <i>Endymion.</i> | 9. <i>Devastation.</i> |
| 4. <i>Serapis.</i> | 10. <i>Captain.</i> |
| 5. <i>Invincible.</i> | 11. <i>Glutton</i> |
| 6. <i>Achilles.</i> | |

vessels appear with reference numbers, enabling them to be distinguished ; and they will repay a careful study, as illustrations of the comparative stabilities of high- and low-sided vessels, armoured and unarmoured. It is only necessary to add that in all cases the weights are supposed to be secured in such a manner that no shift takes place even at the most extreme inclinations. When (as is not uncommon in high-sided ships) stability is maintained beyond the inclination of 90 degrees from the upright—that is to say, when a vessel laid down on her beam-ends would, if left free, return to the upright—this supposition of no shift in the positions of weights may be considered improper ; but it is to be observed that such extreme inclinations are not likely to be reached, whereas for less inclinations the supposition affects all classes similarly. In estimating the relative safety of ships, moreover, it is necessary to consider, not merely the range and area of the curve of stability, but also whether the ship is propelled by sails, or is of the mastless type. This matter will be further discussed hereafter, but is now mentioned to prevent erroneous conclusions being drawn from the simple comparison of curves of stability.

CHAPTER IV.

THE OSCILLATIONS OF SHIPS IN STILL WATER.

IF a ship, floating in still water, has been inclined from a position of stable equilibrium by the action of external forces, and is afterwards allowed to move freely, she will perform a series of oscillations, the range of which gradually decreases, on either side of the position of equilibrium; and will finally come to rest. For all practical purposes attention may be limited to the case of the transverse inclinations and oscillations of ships, reckoning from the upright position where they are in stable equilibrium; and unless specially mentioned, it may be assumed that the following remarks deal only with rolling motions in still water, the other principal oscillations—viz. pitching—not taking place to any sensible extent except in a seaway.

There is an obvious parallelism between the motion of a ship set rolling in still water and that of a simple pendulum moving in a resisting medium. Apart from the influence of resistance, both ship and pendulum would continue to swing from the initial angle of inclination on one side of the vertical to an equal inclination on the other side; and the rate of extinction of the oscillations in both depends upon the resistance, the magnitude of which depends upon several causes to be mentioned hereafter. In what follows, the term "oscillation" will be used to signify a single swing of the ship from port to starboard, or *vice versa*.* The "arc

* In the usual mathematical double swing, say from port to starboard and back again to port; sense an oscillation would mean a

of oscillation" will simply mean the sum of the angles on either side of the vertical swept through in a single swing; for instance, a vessel rolling from 12 degrees inclination to port, and reaching 10 degrees inclination to starboard, would have $(10^\circ + 12^\circ)$ 22 degrees as the arc of oscillation. The *period* of oscillation means the time occupied (in seconds, say) in performing a single swing.

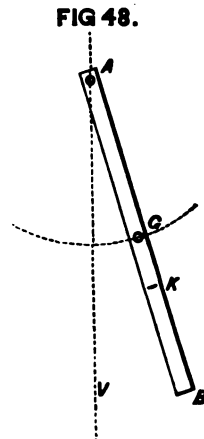
No vessel can roll in still water without experiencing resistance to her motion; but considerable advantage results from first considering the hypothetical case of *unresisted* rolling, and afterwards adding the conditions of resistance. Rigorous mathematical reasoning may be applied to the hypothetical case, but this is not true of an investigation which takes account of resistance; and the highest authorities are content to adopt a mixed method when dealing with resisted rolling, superposing, as it were, data obtained from experiments made to determine the effects of resistance, upon the mathematical investigations of the hypothetical case. No endeavour will here be made to follow out either part of the inquiry, as such a course involves mathematical treatment lying outside the province of this work; but it is possible in popular language to explain some of the chief results obtained, and this we propose to do.

Supposing the rolling of a ship in still water to be unresisted, it may be asked, What is the length of the simple pendulum with which her oscillations keep time, or synchronise? It has been sometimes assumed that the comparison made in the previous chapter between a ship held in an inclined position, and a pendulum of which the length is equal to the distance between the centre of gravity and the metacentre held at an equal inclination, will remain good when the ship and the pendulum are oscillating. In fact, it is supposed that the whole of the weight may be concentrated at the centre of gravity (G, Figs. 30 and 31, page 64), while

but the definition in the text agrees with the practice of the Royal Navy in recording rolling motions, and is therefore followed.

the metacentre is the point of suspension for the ship in motion as well as for the ship at rest. But this is an error, and one that conducts to very false conclusions. If it were true, the stiffest ships, having the greatest heights of metacentre above the centre of gravity, should be the slowest-moving ships, while the crankest ships, with smallest metacentric heights, should move most quickly. All experience shows the direct opposite to be true. For example, a converted ironclad of the *Prince Consort* class, with a metacentric height exceeding 6 feet, will make twelve or thirteen single rolls per minute, and an American monitor, with a metacentric height of 14 feet, will make more than twenty single rolls per minute, while vessels like the *Hercules* or *Sultan*, with metacentric heights under 3 feet, will only make seven or eight rolls per minute. What is thus shown to be true by experience had been previously proved to be true by theory; nearly a century and a half ago, the great French writer Bouguer, in his *Traité du Navire*, had clearly stated the principle, and obtained the formula which is still in use for the period of unresisted rolling.

The necessity for carefully distinguishing between the cases of rest and motion in a ship may be simply illustrated by means of a bar pendulum (such as AB, Fig. 48) of uniform section, having its centre of gravity at the middle point, G. To hold the pendulum at any steady inclination to the vertical must require a force exactly equal to that required to hold at the same inclination a simple pendulum of length AG, and of equal weight to the bar pendulum. But if this simple pendulum were constructed, and set moving, it would be found to move much faster than the bar pendulum. The simple pendulum keeping time with the bar instead



of having a length AG equal to one-half of AB, will have a length AK equal to two-thirds of AB; and it is important to notice the causes producing this result.*

Suppose the pendulum to have reached one extremity of its swing, and to be on the point of returning: at that instant it will be at rest. As it moves back towards the upright, its velocity continually increases, reaching a maximum as the pendulum passes through the upright position, and afterwards decreasing until at the other extremity of the swing it will once more be instantaneously at rest. These changes of velocity, accelerations or retardations, from instant to instant can only be produced by the action of certain forces; and according to the first principles of dynamics, these changes of velocity really measure the intensity of the forces. For instance, a body falling freely from a position of rest acquires a velocity of rather more than 32 feet in a second; at the end of two seconds it has a velocity of rather more than 64 feet (twice that acquired in one second), and so on. Consequently the velocity acquired per second—some 32 feet—is regarded as a measure of the force of gravity; and all other accelerating forces can be compared with it, the ratios of the velocities added by them per second to the 32 feet added by gravity expressing the ratios of these forces to that of gravity. In the case of the simple pendulum, the bob moves in a circular arc, having a radius equal to the length of the pendulum; hence the *linear* velocity of the bob in feet per second may be expressed in terms of the product of this radius into the *angular* velocity.†

* A *simple* pendulum, as previously explained, is one having all its weight concentrated at one point (the "bob"), and supposed to be hung from the centre of suspension (A, Fig. 48) by a weightless rod. The point K in Fig. 48 is termed the "centre of oscillation," and the bar pendulum will oscillate in the same time, whether it is

hung at A or at K.

† The angular velocity may be defined as the angle swept through per second if the motion is uniform, or that which would be swept through per second if the rate of motion existing at any instant were continued for a second. These angles are stated in circular measure

Similarly, the changes in velocity, measuring the accelerating forces, may be expressed in terms of the product of the radius into the changes of angular velocity. These accelerating forces at any instant act at right angles to the corresponding position of the pendulum rod; and so finally we obtain for the simple pendulum:—

$$\left. \begin{array}{l} \text{Moment of accelerating} \\ \text{forces about centre of} \\ \text{suspension} \end{array} \right\} = C \times \text{weight of the bob} \times (\text{radius})^2 \times \text{change of angular velocity};$$

where C is a constant quantity (viz. $\frac{1}{g}$, nearly—the reciprocal of the velocity per second due to gravity). Hence follows this important principle: for any heavy particle oscillating about a fixed axis the moment of the accelerating forces at every instant involves the product of the weight of the particle by the *square* of its distance from the axis of rotation.

Turning from the simple pendulum to the bar pendulum (Fig. 48), we may consider the latter as made up of a number of heavy particles, and take each separately. For example, take a particle of weight w at a distance x from the axis of rotation (A); the moment of the accelerating force upon it, about the point A , is given by the expression,

$$\text{Moment} = C \times w \times x^2 \times \text{change of angular velocity.}$$

At any instant the change of angular velocity is the same for all particles in the bar-pendulum, whatever may be their distance from A ; whence it follows that for the whole of the particles in the bar-pendulum—

$$\left. \begin{array}{l} \text{Moment of accelerating forces} \\ \text{at any instant} \end{array} \right\} = C \times \text{weight of bar} \times k^2 \times \text{change of angular velocity.}$$

To determine k^2 , we have only to sum up all such products as $w \times x^2$ for every particle in the bar, and divide the sum by the total weight of the bar. Or, using Σ as the sign of summation,

$$k^2 = \frac{\Sigma (wx^2)}{\text{Weight of bar}}.$$

Turning to the case of a rigid body like a ship, oscillating about a longitudinal axis which may be assumed to pass through the centre of gravity, it is only necessary to proceed similarly. Take the weight of each elementary part, multiply it by the square of its distance from the axis of rotation, obtain the sum of the products (which sum is termed the "moment of inertia"), and divide it by the total weight of the ship; the quotient (k^2) will be the square of the "radius of gyration" for the ship when turning about the assumed axis. If the whole weight were concentrated at the distance k from the axis of rotation, the moment of the accelerating forces and the moment of inertia would then be the same as the aggregate moment of the accelerating forces acting upon each particle of lading and structure in its proper place.

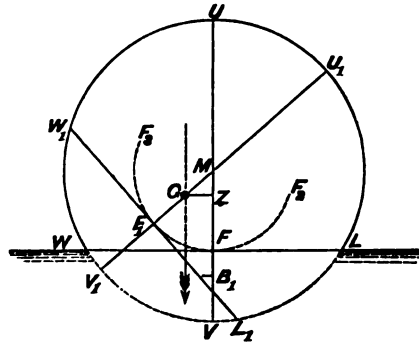
It will be obvious from this attempt at a popular explanation of well-known dynamical principles why we cannot assume that a ship in *motion* resembles a simple pendulum suspended by the metacentre, and having all the accelerating forces acting through the centre of gravity. These accelerating forces developed by motion constitute, in fact, a new feature in the problem, not requiring consideration when there is no motion. For a position of rest, it is only necessary to determine the sum of the statical moments of the weight of each element about the centre of suspension, and this sum equals the moment of the total weight concentrated at the centre of gravity. But for motion, there is the further necessity of considering the moment of inertia, as well as the statical moment, and this fact has sometimes been overlooked.

A ship rolling in still water does not oscillate about a *fixed axis*, corresponding to the centre of suspension (A) of the pendulum in Fig. 48; but still her motions are similar to those of the pendulum. At the extremity of a roll, when her inclination to the upright is a maximum, the moment of statical stability is also usually a maximum, and this is an unbalanced force, tending to restore the vessel

to the upright. She therefore begins to move back, and at each instant during her progress towards the upright is subject to the action of a moment of statical stability tending to make her move in the same direction, and consequently quickening her speed. But the moment of stability gradually decreases in amount, and at the upright is zero; the velocity reaching its maximum at that position. On the other side of the upright the statical stability opposes further inclination, and at every instant grows in magnitude; the result is a retardation of speed, and finally a termination of the motion of the ship at the other end of the roll at an inclination to the vertical equal to that from which she started. All this, be it observed, is on the hypothesis of *unresisted* rolling. As a matter of fact, with resistance in operation, it always acts as a retarding force, tending to extinguish the oscillations.

The position of the instantaneous axis about which a ship is turning at any moment, supposing her motion to be unresisted, may be determined by means of a geometrical construction due to the late Canon Moseley. It may be most simply explained by reference

FIG. 49.



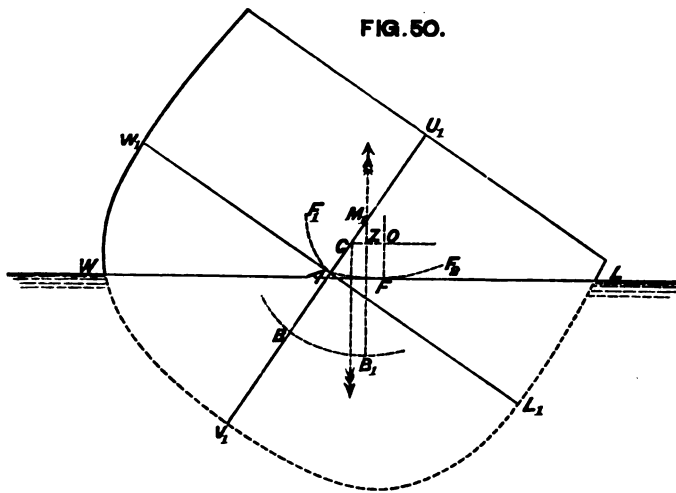
to a cylindrical vessel with circular cross-section such as is shown in Fig. 49. If a circle F_2FF_3 be described concentric with the circular section, and touching the water surface at F , this circle will touch the water-line corresponding to any other inclined position; for all the tangents to this circle cut off from the circular section a segment equal in area to WVL . The circle $F_3F_1F_2$ is

termed the "curve of flotation," and a right cylinder described upon it as base would have this property: if the water surface is supposed to become rigid and perfectly smooth, and the cylinder, of which F_3F_1F is a section, is supposed also to have a perfectly smooth surface, and to project before and abaft the ship, carrying her with it while the projecting ends roll upon the water surface, the conditions for unresisted rolling will be fulfilled. To determine the instantaneous centre, it is then only necessary to consider the simultaneous motions of the point of support, or "centre of flotation," F , and the centre of gravity G . The point F has its instantaneous motion in a horizontal line; consequently it must be turning about some point in the vertical line FM . As to the motion of the centre of gravity, it must be noticed that, resistance being supposed non-existent, the only forces impressed upon the floating body are the weight and buoyancy, both of which act vertically; therefore the motion of translation of the centre of gravity must be vertical, and instantaneously G must be turning about some point in the horizontal line GZ . The point Z , where the two lines GZ and FM intersect, will, therefore, be the instantaneous centre about which the vessel turns.

This simple form of vessel always has the centre of buoyancy B , the centre of flotation F , and the metacentre M in the same vertical line, for any position it can occupy. An ordinary ship presents different conditions, as shown in Fig. 50; where the centre of flotation F does not lie on the vertical line B_1ZM . Here, however, the same principles apply: G moves about some centre in the line GZO ; F about some centre in the vertical line FO ; the point of intersection O of these two lines fixes the instantaneous axis for the whole ship.

Ordinarily the centre of gravity G lies near to the water-line (W_1L_1 , Fig. 50) for the upright position; while in high-sided ships, for oscillations of 12 or 15 degrees on either side of the vertical, the centre of flotation F does not move far away from the middle-line A of the load-line section W_1L_1 .

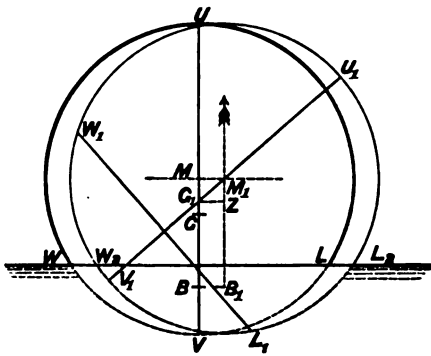
In other words, the common case for vessels of ordinary form is that where the instantaneous axis passes through or very near to the centre of gravity. This has been verified by actual experiment on ships rolling in still water, and may be accepted as practically accurate, within the limits of rolling named, for all except vessels of very exceptional form. Although the position of the instantaneous axis changes from instant to instant (as its name implies), it is not



productive of any serious error in most cases to regard the ship as rolling about a fixed axis passing through the centre of gravity. In theoretical investigations no such assumption is necessary, because the principle known in dynamics as the "conservation of the motions of translation and rotation" then becomes applicable. The motion of *translation* of the centre of gravity is considered separately from any motion of *rotation*; this latter motion being then supposed to take place about an axis passing through the centre of gravity. By this means the "period" of an oscillation in still water can be very closely approximated to, although there is no fixed axis of rotation.

It may be interesting to show how the metacentre moves during rolling, instead of being fixed in space, as is often supposed. Taking once more the cylindrical vessel of circular cross-section, we have a case where the metacentre is fixed *in the vessel*, but moves *in space* as the vessel rolls. In Fig. 51 the darker circle represents the vessel in her

FIG. 51.



upright position; the lighter one shows her position at the extremity of the roll. The centre of gravity G moves *vertically*, as explained above, and during the roll rises from G to G_1 , the corresponding position of the metacentre being M_1 . As the ship rolls, therefore, the meta-

centre sways to and fro horizontally; but in less simple forms it would neither be fixed in the vessel nor have so simple a motion.

Summing up the preceding remarks on unresisted rolling, it appears that the active agent in producing the motion, after the vessel has once been inclined and then set free, is the moment of statical stability; and that the moment of inertia about a longitudinal axis passing through the centre of gravity is also of great importance. Mathematical investigation leads to the following expression for the period of oscillation of a ship:—

Let k = her radius of gyration (in feet),
 m = metacentric height (GM) (in feet),
 T = period in seconds for a single roll.

$$\text{Then } T = \Pi \sqrt{\frac{k^2}{gm}} = 3.1416 \sqrt{\frac{k^2}{gm}}$$

where g (measuring force of gravity) = $32\frac{1}{2}$ feet (nearly) per second. This may be written,

$$T = .554 \sqrt{\frac{k^2}{m}}$$

The fractional expression $\left(\frac{k^2}{m}\right)$ in this equation enables one to ascertain the effect upon the period of changes in either the radius of gyration or the metacentric height. They may be summarised as follows:—

Period is increased by—

- (1) Increase in the radius of gyration ;
- (2) Decrease in the metacentric height.

Period is decreased by—

- (1) Decrease in the radius of gyration ;
- (2) Increase in the metacentric height.

It has already been explained (see page 67) that the designer of a ship has comparatively little power over the vertical distribution of the weights and the position of the centre of gravity, which are practically controlled by the requirements for accommodation, stowage, protection, &c. Nor has he great power over the moment of inertia of the ship, whereas he can exercise a considerable influence over the value of the metacentric height. Changes in the metacentric height are, therefore, the most important means, in ship design, of influencing the period of still-water oscillations, and the steadiness at sea. Within the last fifteen years, since the modern theory of rolling in a seaway introduced by Mr. Froude has been generally accepted, great attention has been paid to the proportions of ships, in order to secure metacentric heights which combine sufficient stiffness with the longest obtainable periods of still-water oscillations, or, as they are frequently termed, "natural periods." The tendency has, therefore, been to reduce the metacentric heights where that was possible; deep bilge-keels being used to decrease rolling when great metacentric heights were unavoidable. The following table exhibits for different

classes of war-ships the still-water periods and the metacentric heights; as well as the approximate lengths of simple pendulums keeping time with the ship; and by comparing these with the metacentric heights, the fallacy of the view previously exposed will be made still more obvious.

Name.	Class of Ships.	Period.	Metacentric Height.	
			Feet.	Approximate Length of Synchronous Simple Pendulum.
		Seconds.		Feet.
<i>Onondaga</i> . . .	{ American monitor type of French navy . . . }	2.7	14	25
<i>Cerbère</i> . . .	{ Coast defence vessel of French navy . . . }	3.9	7½	50
—	{ Unarmoured screw fri- gate of old type . . . }	5 to 5½	4 to 5	90
<i>Prince Consort</i> .	{ Converted ironclad . . . }	5 to 5½	6½	90
<i>Flandre</i> . . .	{ French ironclad frigate (early type) . . . }	6	4	120
<i>Devastation</i> . .	{ Mastless type of iron- clad in Royal Navy . . }	6.76	3½ to 4	150
<i>Magenta</i> . . .	{ French ironclad two- decker }	7½	3½	175
<i>Inconstant</i> . . .	{ Swift unarmoured frigate, Royal Navy }	8	2.8	210
<i>Sultan</i>	{ Ironclad frigate, Royal Navy (modern type) . }	8.9	2½	260

This table, of course, presents no information concerning the moments of inertia of the ships, and is, therefore, not a complete representation of the conditions affecting the period; but it illustrates broadly the important principle that a decrease in the metacentric height leads to a lengthening of the natural period, and *vice versa*.

To determine the moment of inertia of a ship involves a very laborious calculation, the weight of each part of the structure and lading having to be multiplied by the square of its distance from the axis of rotation. But this calculation has been made for some few ships, and by means of the

formula on page 113 the still-water periods have been obtained within very narrow limits of the truth. As examples of close estimates of natural periods we may refer to the *Devastation* and a monitor of the American type, which were under the consideration of the Admiralty committee on designs for war-ships. It was estimated that the *Devastation* would have a period of about 7 seconds; the actual period obtained by experiment was $6\frac{3}{4}$ seconds. The estimated period for the American monitor was $2\frac{1}{2}$ seconds; the actual period, $2\frac{7}{10}$ seconds. The formula given for the period supposes the rolling to be unresisted; but the influence of resistance is much more marked in the extinction of oscillations than it is in affecting the period of oscillation, and this accounts for the close agreement of estimates made from the formula with the results of experiments. In the formula for the period it is further assumed that there is no sensible difference between the time occupied by the ship in swinging through large or small arcs, within a range of, say, 12 or 15 degrees on either side of the vertical; for which range the metacentric method of estimating the stability gives fairly accurate results. This condition has been proved by direct experiment to be fulfilled very nearly in vessels of ordinary form and high freeboard; vessels of very low freeboard present exceptional cases. For example, the *Sultan* was rolled in still water by Mr. Froude, until an extreme inclination of nearly 15 degrees on either side of the upright was reached, and then allowed to come to rest, the observations being continued until the extreme inclination attained was only 2 degrees; but the period of rolling through the arc of 30 degrees was practically identical with that for the very small arc of 4 degrees. This noteworthy fact is usually expressed by the statement that the rolling of ordinary ships is *isochronous* within the limits named above.

Changes in the distribution of the weights on board a ship must affect her period, because they will usually affect both the metacentric height and the moment of inertia. It is unnecessary to say more respecting the influence of the

metacentric height; but a few remarks are called for as to the effect of changes in the moment of inertia. "Winging" weights—that is, moving them out from the middle line towards the sides—increases the moment of inertia, and tends to lengthen the period. The converse is true when weights—such as guns—are run back from the sides towards the middle line. Raising weights also tends to decrease the moment of inertia, if the weights moved are kept below the centre of gravity; whereas, if they are above that point, the corresponding change tends to increase the moment of inertia. But all such vertical motions of weights have an effect upon the position of the centre of gravity, altering the metacentric height, and affecting the moment of inertia by the change in the position of the axis about which it is estimated. It is therefore necessary to consider both these changes before deciding what may be their ultimate effect upon the period of rolling. The principles stated above will enable the reader to follow out for himself the effect of any supposed changes in the distribution of the weights, and it is not necessary to give more than one or two examples. A ship of 6000 tons weight has a metacentric height of 3 feet and a period of 7 seconds; a weight of 100 tons is raised from 15 feet below the centre of gravity to 15 feet above. In consequence of the transfer of the weight, the centre of gravity will be raised, and we have,

$$\text{Rise of centre of gravity} = \frac{100 \text{ tons} \times 30 \text{ feet}}{6000} = \frac{1}{2} \text{ foot.}$$

$$\text{New value of GM} = 3 - \frac{1}{2} = 2\frac{1}{2} \text{ feet.}$$

Originally, according to the formula for the period,

$$7 = .554 \sqrt{\frac{k^2}{3}},$$

$$k = \frac{7}{.554} \sqrt{3} = 22 \text{ (nearly).}$$

The rise in the centre of gravity slightly alters the position of the axis about which the ship is considered to revolve, and this produces a change in the moment of inertia; but the change is so small that it may be neglected.

Then, after the weights are moved, the period T will be given by the equation,

$$T = .554 \sqrt{\frac{k^2}{2\frac{1}{2}}}$$

$$\therefore \frac{T}{7} = \sqrt{\frac{3}{2 \cdot 5}} = 1.1$$

$$\therefore T = 7 \times 1.1 = 7.7 \text{ seconds (nearly).}$$

The decrease of 6 inches in the metacentric height thus lengthens the period about 10 per cent.

As a second case, suppose weights amounting in the aggregate to 100 tons, placed at the height of the centre of gravity, to be "winged" 15 feet from the middle line; their motion being horizontal does not affect the position of the centre of gravity.* Then we have,

Original moment of inertia = $6000 \times k^2$,
 Additional moment of inertia = $100 \times 15^2 = 22500$.
 \therefore New moment of inertia = $6000 \times k^2 + 22500$.
 (New radius of gyration)² = $\frac{6000 \times k^2 + 22500}{6000}$
 $= k^2 + \frac{15}{4}$.

Originally, 7 seconds = $.554 \sqrt{\frac{k^2}{3}} \dots \dots \dots (1)$

Now $T = .554 \sqrt{\frac{k^2 + \frac{15}{4}}{3}} \dots \dots \dots (2)$

Therefore $T = 7 \sqrt{1 + \frac{15}{4k^2}}$; also $k^2 = 475$

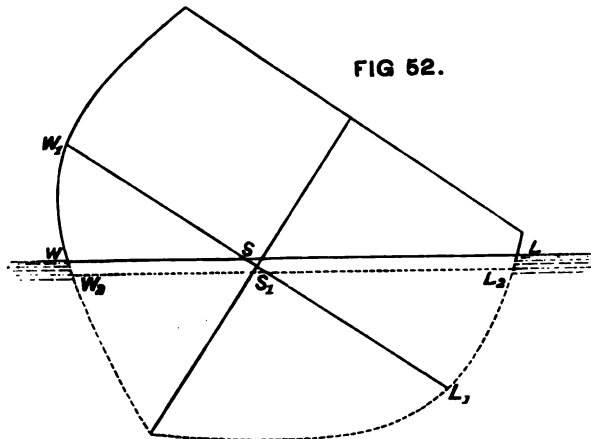
$$\therefore T = 7 \sqrt{1 + \frac{15}{1900}} = 7 \times 1.004$$

$$= 7.028 \text{ seconds.}$$

* The expressions for changes in the moment of inertia produced by winging weights not originally at the middle line, nor placed at the height of the centre of gravity, can be easily formed; it is only necessary to determine for each position the actual distances of the weights from the axis passing through the centre of gravity.

This alteration in period is very slight, as compared with that produced by the supposed transfer of weight in a vertical sense, and furnishes an illustration of the much greater changes rendered possible by alterations of metacentric heights than by changes in the moments of inertia.

Besides the motion of rotation about an axis passing through the centre of gravity of a ship rolling in still water, there is a motion of translation of the centre of gravity up and down a vertical line; and in the case of the cylindrical vessel (Fig. 51) we have seen how the metacentre moves in order to fulfil the condition of keeping the volume of



displacement unchanged. But in few, if any, actual ships can this condition of constancy of displacement be accurately fulfilled at each instant; and with certain forms of cross-section, such as the Symondite type in Fig. 52, the departure from this condition is very considerable, giving rise to what are called "dipping oscillations" and "uneasy" rolling. Let it be assumed, for example, that the ship in Fig. 52 has rolled until W_1L_1 , which was her upright water-line, has come to the position shown, the motion probably occupying only 2 or 3 seconds. Then it may, and does, happen that the wedge immersed (LSL_1) will be instantaneously greater than the wedge emerged (WSW_1);

for, as already explained, during such a motion, if the roll does not exceed 15 degrees, the instantaneous centre will be nearly coincident with the centre of gravity, and this in war-ships of the Symondite type was near the load water-line. Suppose W_2L_2 to be the water-line at which the vessel would float if steadily held at the assumed inclination; for the instant, the buoyancy of the layer WW_2L_2L constitutes an unbalanced lifting force, which tends to set up a vertical motion in the ship. The ratio which the buoyancy of this layer bears to the total displacement of the ship determines whether this vertical motion will be considerable or not; and it is obvious that with the "peg-top" form of section in Fig. 52 the buoyancy of the layer may be great in proportion to the total buoyancy. Moreover, after motion begins, as the water-line W_2L_2 is moved upwards towards WL , there will still remain an unbalanced upward buoyancy, although one decreasing in amount, up to the instant that W_2L_2 reaches the water surface; and consequently, instead of stopping, the ship will be carried on beyond its position of rest, just as a pendulum inclined on one side of the vertical swings over to the other, past its position of rest in the vertical. Hence it follows that, if the vessel were conceived to be kept at the inclination shown, by forces that left her free to move vertically, she would "dip" upwards and downwards about her statical position of rest until the resistance of the water extinguished her oscillations.

Although ships rolling in still water are not thus held at a definite inclination, they are at each inclination subjected to conditions of a similar character, and they have a period for their dipping oscillations which may be determined approximately, and the ratio of which to that of their rolling oscillations exercises an important influence upon the extent to which dipping proceeds. A single roll, even of a Symondite ship, may not produce much vertical motion, but a succession of rolls may; and the explanation of this fact is thus given by Professor Rankine:—"Each roll sets going a fresh series of dipping oscillations, and should the periodic

“time of rolling happen to be double, quadruple, or any even multiple of the periodic time of dipping, so that each roll coincides with the rising part of the previously existing dipping motion, the extent of the dipping motion may go on continually increasing to an amount limited only by the resistance of the water.” In short, when these ratios of the periods of dipping and rolling obtain, the ship is in a condition similar to that of a pendulum which receives periodically a fresh impulse at the end of its swing; and it is a matter of common observation how such an impulse, although in itself not of great magnitude, may by its repeated applications in the manner described lead to considerable oscillations. Dipping motions have not, however, the practical importance of rolling motions, and therefore they will not be further discussed. In vessels of ordinary form these motions are not nearly so extensive as in vessels of the Symondite type, and the reasons for the difference will be obvious.

Turning attention to the effect of fluid resistance upon the rolling of a ship in still water, that resistance may be subdivided into three parts:—(1) Frictional resistance due to the rubbing of the water against the immersed portions of the ship, and particularly experienced by the amidship parts where the form is more or less cylindrical. (2) Direct or head resistance, similar to that experienced by a flat board pushed through the water, and chiefly developed against the keel, bilge-keels, deadwood, and flat or nearly flat surfaces lying near the extremities of the ship. (3) Surface disturbance, which involves the creation of waves that move away from the ship, and have continually to be replaced by new-made waves, each creation involving, of course, a certain expenditure of energy, which must react upon the vessel, and be equivalent to a check upon her motion. The aggregate effect of these three parts of the fluid resistance displays itself in the gradual extinction of the oscillations when the ship rolls freely under the action of no external forces other than gravity and buoyancy; and if

observations have been made of the rate at which extinction proceeds in any ship, it is possible to infer from thence the total resistance for that ship, or for one identical with or very similar to her. But to estimate by direct calculation the value of the resistance for a ship of novel form, or for any ship independently of reference to rolling trials for similar ships, is not, in the present state of our knowledge, a trustworthy procedure. This difficulty in theoretical investigation arises chiefly from the doubtfulness surrounding any estimate of the "wave-making function" for an untried type. Having experimental data such as Mr. Froude has made available, it is possible to approximate to the first two parts of the resistance, but the third, as yet, seems outside calculation. For example, when the character of the bottom of a ship is known—whether she is iron-bottomed, or copper-sheathed, or zinc-sheathed, and whether clean or dirty—it is possible to obtain the "coefficient of friction" for the known conditions; then knowing the area of the surface upon which friction operates, and the approximate speed with which the ship rolls, the total frictional resistance may be found within narrow limits of accuracy. Similarly, when the "coefficient of direct resistance" for the known speed has been determined by experiments on a board or plane surface, it may be applied to the total area of keel, bilge-keels, deadwood, &c., and so a good approximation made to the total "keel" or "direct" resistance. But the wave-making function cannot be similarly treated, and so it becomes most important to make rolling experiments in still water, in order that the true value of the resistance may be deduced from the observations. The importance of the deductions arises from the fact that fluid resistance has very much to do with controlling the maximum range of oscillation of a ship rolling in a seaway. This will be explained in a future chapter; for the present it is sufficient to remark that, if the rate of extinction of still-water oscillations is rapid, it may be assumed that the range of rolling at sea will be greatly limited by the action of the resistance; whereas,

if the rate of extinction is slow, resistance will exercise comparatively little control over the behaviour of the ship at sea.

Rolling experiments in still water were recommended strongly by Bouguer in the *Traité du Navire* published in 1746, but their performance has only become common within the last few years. Mr. W. Froude, F.R.S., has conducted the greater number of those made on ships of the Royal Navy, and to him we owe our most valuable information on the subject; a few experiments have been made by officers in command. In the French navy such experiments have been made systematically for some years, and many of the results obtained have been collected and published. The objects of these experiments are twofold: (1) to ascertain the period of oscillation of the ship; (2) to obtain the rate of extinction of the oscillations, when the vessel is left free to move and gradually come to rest. Various means may be employed to produce the desired inclination, from which the vessel is to have her rolling motion observed. If she is small, she may be "hove-down," and, after reaching the required inclination, suddenly set free. But this is a process inapplicable to large ships, and the following is the plan usually adopted.

A number of men are made to run across the deck, from side to side, their motions being regulated by some concerted signal, so that they may run out from the middle line to the side and back again, while the ship performs a half-oscillation. By this simple means even the largest ships may be made to accumulate motion very quickly, and to roll through considerable angles, the running of the men being so timed as never to retard, but always to accelerate, the rolling. For example, her Majesty's ship *Sultan* was made to roll to an angle of $14\frac{1}{2}$ degrees from the upright by the motion of her own crew of about six hundred men, under Mr. Froude's direction; while the *Devastation*, weighing over 9000 tons, was made to reach a heel exceeding 7 degrees by four hundred men running eighteen times across her deck. If the motions of the men are not well timed, similar results

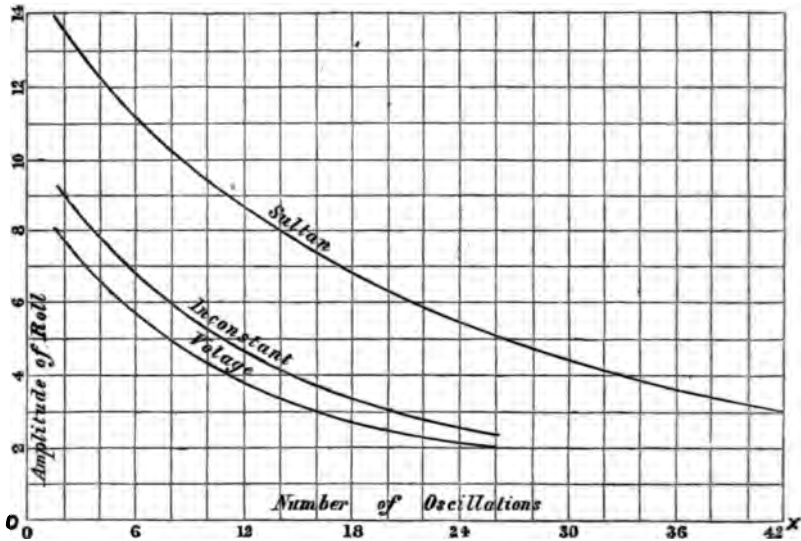
will not be obtained, and in some trials large angles of oscillation have not been secured, on account of non-compliance with this condition. When a sufficiently large range of oscillation has been obtained, the men are made to stand still, and the observations are commenced.

In order to determine the period for a single roll, careful note is taken of the times occupied by the ship in performing each of several successive single rolls; and in this way the fact has been established that vessels of ordinary form are practically isochronous in their rolling motions. Hence, in fixing the period for a ship, it is usual to observe how many oscillations (n , suppose) are made in a certain interval of time (T seconds, suppose); then the period = $\frac{T}{n}$.

Careful observations are also made of the extreme angles of heel reached at the end of each oscillation; the difference between the successive values marking the rate of extinction. A vessel starting from an inclination of (say) 10 degrees to port only reaches an extreme heel of 9 degrees to starboard, and then rolls back to $8\frac{1}{2}$ degrees to port; gradually coming to rest. These observations are commonly continued until the arc of oscillation has diminished to 2 or 3 degrees. Mr. Froude has devised beautiful automatic apparatus for recording the rolling motion of the ship in such a manner that the angle of inclination, at each instant of her motion, as well as her extreme angles of heel, can be traced, and the period also determined. But with the aid of the simplest apparatus it is possible to make all the observations needed, and in a future chapter the common plan will be described. The gradual degradation in the range of oscillation is represented by means of, what are termed, "curves of extinction"; examples of these curves, obtained from Mr. Froude's experiments, are given in Fig. 53, for her Majesty's ships *Sultan*, *Inconstant*, and *Volage*. A very brief explanation of the construction of these curves will suffice. On the base-line OX are set off equal spaces, each representing an oscillation;

and since each oscillation is performed in the same period, each of these spaces also represents a certain number of seconds. Any ordinate, drawn at right angles to OX, through the points marking these equal spaces, shows the extreme angle of heel reached at that particular oscillation; and the difference between any two ordinates so drawn shows the loss of range, or extinction of the rolling, in the corresponding number of oscillations. For example, after making

FIG. 53.



twelve oscillations from the extreme angle ($13\frac{1}{2}$ degrees) where the record of observations begins, the *Sultan* only reached an extreme angle of 8 degrees, the loss of range in that number of rolls being $5\frac{1}{2}$ degrees. Here the rate of extinction was slow, the vessel having a large moment of inertia, no keel, and only shallow bilge-keels, to assist the extremities in developing resistance to the motion. If there were deeper bilge-keels, the rate of extinction would be much more rapid.

Experiments have been made by Mr. Froude to show how

rapidly the rate of extinction may be increased by deepening bilge-keels. A model of the *Devastation* was used for this purpose, and fitted with bilge-keels which, on the full-sized ships, would represent the various depths given in the following table. The model was one-thirty-sixth of the full size of the ship, and was weighted so as to float at the proper water-line, to have its centre of gravity in the same relative position as that of the ship, and to oscillate in a period proportional to the period of the ship. In smooth water it was heeled to an angle of $8\frac{1}{2}$ degrees, and was then set free and allowed to oscillate until it came practically to rest, the number of oscillations and their period being observed. The following results were obtained :—

Model fitted with—	Number of Double Rolls before Model was practically at rest.	Period of Double Roll.
		Seconds.
1. No bilge-pieces	31½	1.77
2. A single 21-inch bilge-keel on each side	12½	1.9
3. " 36-inch " " "	8	1.9
4. Two 36-inch bilge-keels " " "	5½	1.92
5. A single 72-inch bilge-keel " "	4	1.99

The great advantages resulting from the use of bilge-keels are obvious from this table. It will be noted that the period of oscillation is changed but very little as the resistance becomes increased; this being a result which theory had predicted, and one which justifies the use of the hypothesis of unresisted rolling in approximating to the period of a ship. Increased resistance, however caused, is equivalent to an increase in the moment of inertia, and therefore tends to lengthen the period somewhat from that for unresisted rolling, but the difference is not so great as to require attention in the broad practical deductions with which we are chiefly concerned. The rate of extinction of the oscillations depends upon the proportionate effect of the resistance and the moment of inertia of the ship; and

other things being equal, the ship which has the great moment of inertia will be the more difficult to set in motion but afterwards her motion is likely to be longer sustained.

The investigations by which the value of the resistance is deduced from curves of extinction are of such character that they cannot here be reproduced, but they proceed on the principle that the loss of range per oscillation represents an amount of "work" done by the resistance and this amount can be ascertained by calculating the dynamical stability corresponding to the loss of range. Mr. Froude has been the chief investigator in this field, and his published analyses of numerous experiments are full of interest and instruction. Not content with obtaining the aggregate value of the resistances for ships, he has separated them into their component parts, assigning values to frictional and keel resistances, as well as to surface disturbance. In doing so, Mr. Froude has been led to the conclusion that surface disturbance is by far the most important part of resistance, as the following figures given by him for a few ships will show.

Ships.	Frictional.	Keel, Bilge-keel, and Deadwood.	Total Resistance.	Surface Disturbance.
<i>Sultan</i> . . .	354	5036	20,000	14,510
<i>Inconstant</i> . .	140	4060	21,500	17,300
<i>Volage</i> . . .	96	2944	14,100	11,060
<i>Greyhound</i> . .	120	700	4,700	3,880

Frictional and bilge-keel resistances in this table have been obtained by calculation from the drawings of the ship, Mr. Froude making use of data as to coefficients for friction and for head resistance which he had previously obtained by independent experiments, and which may therefore be regarded as leading to thoroughly trustworthy results. The total resistance in each case was deduced from the curves of extinction obtained from still-water rolling experiments.

* The formulæ for dynamical stability will be given and explained farther on in this chapter.

periments; and this also must be regarded as accurate. But it will be noticed that in no case does the sum of the frictional and keel resistances much exceed one-fourth of the total resistance, while it is much less than one-fourth in other cases. The consequence is that surface disturbance must be credited with the contribution of *three-fourths* or thereabouts of the total resistance, a result which could scarcely have been predicted. Waves are constantly being created as the vessel rolls, and as constantly moving away, and the mechanical work done in this way reacts in a reduction of the amplitude of successive oscillations. Very low waves, so low as to be almost imperceptible, owing to their great length in proportion to their height, would suffice to account even for this large proportionate effect. For example, Mr. Froude estimates that a wave 320 feet long and only $1\frac{1}{4}$ inch in height would fully account for all the work credited to surface disturbance in the fourth case of the preceding table.

Another important deduction from the figures in the table is the large proportionate effect of "keel" resistance, as compared with frictional resistance, thus confirming what was said above as to the advantages of deep bilge-keels. Ships of the Royal Navy recently constructed have been furnished with much deeper bilge-keels than were formerly in use, but a limit to the depths that can be fitted is often reached, because of the necessity for compliance with certain conditions and extreme dimensions in order that the vessels may be able to enter existing docks. The evidence in favour of the use of bilge-keels is now considered unquestionable, and hereafter examples will be given of their usefulness as regards limitation of the rolling of ships in a seaway; but only a few years have elapsed since eminent naval architects, like M. Dupuy de Lome, of the French navy, regarded bilge-keels with suspicion. The change of opinion that has taken place is mainly the consequence of direct experiment and careful observation; and it furnishes another instance of the use of theoretical investigations in giving a

direction to practice; for these investigations had led to the conclusions now generally accepted before experimental knowledge had reached its present stage.

Exception has been taken by some eminent French writers to the views propounded by Mr. Froude as to the relative influence of the several component parts of the fluid resistance; but their objections are in no way directed against the experimental data obtained by Mr. Froude, these data being matters of actual observation, and not of theoretical calculation. We are bound to say, however, that, after carefully considering these objections and the accounts of French rolling experiments which have been published, we are strongly of opinion that Mr. Froude has the best of the argument; and his view of the importance of surface disturbance derives considerable support from experiments made on very special forms of ships. For example, in experimenting upon the model of the *Devastation*, Mr. Froude found that, when the deck-edge amidships was considerably immersed before the model was set free to roll, the deck appeared to act like a very powerful bilge piece, rapidly extinguishing oscillations. MM. Risbec and de Benazé, of the French navy, also found by experiment that, when bilge-keels were moved high up the sides of a vessel, so that, as she rolled, the bilge-keels emerged from the water and entered it again abruptly, their effect became much greater than when they were more deeply immersed; as one would anticipate from the increased surface disturbance that must exist when the bilge-keels are so high on the sides. Experience with the low-freeboard American monitors furnishes further support to this view; immersion of the deck and the existence of projecting armour developing greatly increased resistance—a circumstance which undoubtedly tells much in favour of these vessels, and assists in preventing the accumulation of great rolling motions.

Fluid resistance to the motion of a floating body, or of a body immersed in it, depends upon the rate of motion. When a flat surface is pushed forwards, the direct or head

resistance, corresponding to the velocity, varies with the area of the surface, and with some power of the velocity, and so would also the frictional resistance experienced by a thin board drawn end-on through the water. The usual assumptions have been that for moderate speeds the resistance varied as the *square* of the velocity, that for very low speeds it varied nearly as the first power of the velocity, and for high speeds at a greater power than the square. For such speeds as are common in the rolling of ships, it is probable that the keel and frictional resistances vary nearly as the square of the angular velocity; and this is the law which French investigators agree in applying to the *total effect* of the resistance. Mr. Froude, however, whose experience and labours in this subject, as well as his numerous experiments, give to his conclusions exceptional authority, is of opinion that the total resistance consists of two parts, one varying as the square of the angular velocity, the other as the first power. The former comprehends keel and frictional resistances; the latter is mainly represented by surface disturbance. It is only proper to add that by the analysis of curves of extinction given by French writers, as well as of curves obtained from his own experiments, Mr. Froude has given good reason for accepting his law of resistance.

Ships of ordinary form being isochronous for moderate angles of inclination on either side of the vertical, all their oscillations within limits, say, of 15 degrees on each side being performed in practically the same time, it follows that, as the range of oscillation increases, so will the mean angular velocity increase. Or, as we may say, the mean angular velocity varies with the arc of oscillation. Hence, if θ be the extreme inclination to the vertical reached by a vessel rolling freely, it is possible to express the effect of the resistance (measured by the loss of range) per roll in terms of θ . For example, we may write,

$$\text{Loss of range} = a\theta + b\theta^2,$$

where a and b are constants determined from the still-water

rolling experiments. Expressing θ in degrees, Mr. Froude gives the following values for the *Inconstant*,

$$a = \cdot 035; b = \cdot 0051.$$

Suppose, for instance, the *Inconstant* starts from an inclination to the vertical of 8 degrees; then

Loss of range in a roll = $\cdot 035 \times 8 + \cdot 0051 \times 8^2 = \cdot 61$ degree.

The values of the constants, of course, vary with the character and form of the vessel, the depth of her bilge-keels, and the coefficient of friction. For example, Mr. Froude determined the values to be—

For *Sultan* . . . $a = \cdot 0267; b = \cdot 0016.$

„ *Volage* . . . $a = \cdot 028; b = \cdot 0073.$

If the *Sultan* started from an inclination of 8 degrees, she would suffer

Loss of range in a roll = $\cdot 0267 \times 8 + \cdot 0016 \times 8^2 = \cdot 32$ degree,

or only about one-half as much as the *Inconstant*. The greater inertia of the *Sultan* and the finer form of the extremities in the *Inconstant* would help to account for the different rates of extinction.

The rate of extinction of the still-water oscillations of any ship decreases as she approaches a state of rest. This is a matter of common observation, and is fully borne out by the curves of extinction in Fig. 53, for the *Inconstant*, *Sultan*, and *Volage*. From the foregoing remarks the explanation of this fact is readily obtained; the greater the range of oscillation, the quicker the motion, and the greater the resistance. Motion and the existence of the retarding force due to resistance cease simultaneously; resistance has, therefore, sometimes been termed a “passive” force, but it nevertheless exerts a very important and beneficial effect upon the behaviour of ships at sea.

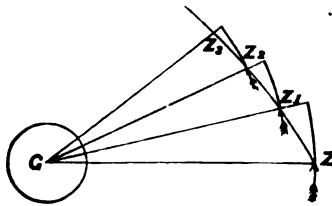
It has repeatedly been proposed to make use of still-water rolling experiments for the purpose of readily checking the good or bad stowage of cargo-carrying merchant ships

before they leave port. Bouguier made this proposal in 1746, and the council of the Institution of Naval Architects endorsed it in 1867. The miscellaneous character of the cargoes carried at various times by any ship necessarily entails very various stowage of the hold; the common practice being to rely upon the experience of stevedores—a class of men skilful in their vocation, but usually possessing little or no knowledge of the theoretical principles underlying good stowage. It has, therefore, been proposed to take careful note of the voyages on which a ship proves herself to be well stowed by her good behaviour; to make a small series of rolling experiments in order to determine the mean period corresponding to these conditions; and then in future voyages to endeavour to stow the vessel in such a manner as to secure approximately the same period as the mean for the successful voyages. It would be a very simple and inexpensive way of obtaining a check upon the character of the stowage before a ship leaves port, whereas it now commonly happens that the information is only obtained under the trying circumstances of bad weather at sea, when changes in stowage cannot be made even if they appear to be desirable. Here, it will be noted, the still-water experiments would terminate with the determination of the period; no attempt would be made to evaluate the resistance.

Before concluding this chapter, a brief exposition of the principles of *dynamical stability* must be attempted. Here we must revert to the conditions of unresisted rolling, with which the reader is already familiar, and assume that no account shall be taken of the effect of fluid resistance. On this assumption, dynamical stability may be defined as the “work” done in heeling the ship from her upright position to any angle of inclination; the amount of work done, of course, varying with the inclination. Work, it need hardly be said, is here used in its mechanical sense of a pressure overcome through a distance; for example, a ton raised one foot may be taken as our unit of work, and then to move 100 tons

through a foot, or a ton through 100 feet, will require 100 units of work, or "foot-tons." It has been shown how to estimate the moment of the couple for statical stability at a given angle; and if the vessel is gradually inclined beyond that angle, the forces inclining her must do work depending upon the righting couples corresponding to the successive instantaneous inclinations, as well as to the ultimate angle attained. In short, it is easy to determine the dynamical stability, when the variations in statical stability are known, and the curve of stability has been constructed.

FIG. 54



A simple illustration may make this clearly understood. A man is pushing at the end of a capstan bar (Z, in Fig. 54) with a force P; the centre of the capstan (G) is distant l feet from Z. Then the statical moment of the pressure P about G will equal $P \times l$, and this exactly corresponds to the expression for the moment of statical stability ($D \times GZ$) obtained in the previous chapter. Now suppose the man to push the bar on through an angle A (circular measure); then—

$$\text{Distance the man walks} = l \times A;$$

$$\begin{aligned} \text{Work he does} &= \text{pressure} \times \text{distance through which it acts} \\ &= P \times l \times A = \text{statical moment} \times A. \end{aligned}$$

Next suppose that, as the man pushes the bar round, he moves inwards along it, decreasing the value of l from instant to instant; then we shall have a parallel case to that of the ship where the arm of the righting couple varies from angle to angle of inclination. The man walks for a *very small* distance from the first position (GZ , Fig. 54), pushing as before; then for that very small angle a , GZ will have practically the constant value l , and (as above)

$$\text{Work} = \text{statical moment (for position } GZ) \times a.$$

By the time he has completed the angle A , he has moved

in on the bar to the position Z_1 ; let $GZ_1 = l_1$. Then, as he pushes with a constant force P , we must have for a very small angle a from the position GZ_1 —

$$\text{Work} = \text{statical moment (for position } GZ_1) \times a.$$

Similarly, for any other position, the work for a very small angle beyond may be expressed in terms of the corresponding statical moment. And what is thus true of the capstan is equally true of a ship; the work for any small inclination a from a given position is given by—

$$\text{Work} = \text{statical moment of stability for that position} \times a = \text{displacement} \times GZ \text{ (for that position)} \times a.$$

Turning next to any curve of stability (say, to Fig. 43, page 96), we have a graphic delineation of the values of GZ for every inclination until the vessel becomes unstable. Supposing OP is taken to represent any assigned angle of inclination, and pn drawn very close to PN (the distance Pp corresponding to the very small angle a), the area of this little strip ($PNnp$) will graphically represent the product $GZ \times a$. Consequently it follows that on the curve of stability for a ship, reckoning from the upright (O) to any angle of inclination (such as OP), the dynamical stability corresponding to that inclination is represented by the area (OPN) cut off by the ordinate corresponding to that inclination. The total area of the curve of stability therefore represents the total work to be done (excluding fluid resistance) in upsetting a ship.

Bearing this fact in mind, fresh force will be given to the remarks made in the previous chapter as to the comparative influence of beam and freeboard upon the form and range of curves of stability; and the contrasts exhibited between the various curves shown in Fig. 47, page 101, become still greater when the consideration of their relative total areas is added to that of their range. These, however, are matters upon which any one so desiring may proceed to independent investigation with the materials afforded; and no more will here be said respecting them.

We owe the term, and the first investigation for dynamic stability, to the late Canon Moseley, and his formula differs somewhat in appearance, though not in fact, from that given above. It may be well, therefore, to briefly indicate the chief steps in Canon Moseley's investigation. Starting from the principle that, apart from resistance, the only external forces impressed upon a ship rolling freely would be her weight and buoyancy, he remarked that the work done up or down in producing any inclination might be expressed in terms of the rise in space of the centre of gravity, where the weight might be supposed concentrated, and the fall of the centre of buoyancy, where the buoyancy might be supposed to be centred. Turning to Fig. 42, page 95, it will be seen that, when the ship is upright, B_1G is the vertical distance between these two centres, whereas in the inclined position their vertical distance becomes equal to BZ . Since the centre of gravity must rise and the centre of buoyancy fall in order that work may be done, we are only concerned with the changes in the *relative* vertical positions of these two points; hence we may write, if V = volume of displacement (in cubic feet),

$$\text{Work done in producing an inclination } \alpha \left\{ \begin{array}{l} \text{(dynamical stability in foot-tons) . . .} \end{array} \right\} = \frac{V}{35} (BZ - B_1G)$$

also

$$BZ = RZ + BR = B_1G \cos \alpha + BR;$$

and by the principle of the motion of the centre of buoyancy previously explained (see page 95),

$$BR = \frac{v}{V} (g_1h_1 + g_2h_2).$$

Substituting these values in the foregoing expression—

$$\begin{aligned} \text{Dynamical stability} &= \frac{V}{35} \left\{ \frac{v}{V} (g_1h_1 + g_2h_2) - B_1G (1 - \cos \alpha) \right\} \\ &= \frac{1}{35} \left\{ v (g_1h_1 + g_2h_2) - V \cdot B_1G \text{ vers } \alpha \right\} \end{aligned}$$

This is Moseley's formula. But, since curves of stability have been commonly constructed for ships, instead of us

this formula, the dynamical stability has been much more easily calculated by the method of areas explained above, and its values for different inclinations are often represented by a curve.

The greatest importance of dynamical stability arises from the means it affords of comparing the safety of ships under the action of *suddenly applied* forces, such as gusts or squalls of wind. These do not, it is true, commonly occur under the condition of smooth water that is assumed throughout the present discussion; but it is convenient to separately consider their effect, and to deal with the action of the waves independently, for which purpose it is necessary to suppose the water still, while the wind acts on the ship.

Roughly speaking, it may be said that a force of wind which, steadily and continuously applied, will heel a ship of ordinary form to a certain angle will, if it strikes her suddenly when she is upright, drive her over to about twice that inclination, or in some cases further still. A parallel case is that of a spiral spring; if a weight be suddenly brought to bear upon it, the extension will be about twice as great as that to which the same weight hanging steadily will stretch the spring. The explanation is simple. When the whole weight is suddenly brought to bear upon the spring, the resistance which the spring can offer at each instant, up to the time when its extension supplies a force equal to the weight, is always less than the weight; and this unbalanced force stores up work which carries the weight onwards, and about doubles the extension of the spring corresponding to that weight when at rest.

One point of difference, however, will become obvious between the cases of the ship and the spring. It has been virtually assumed that the vessel, with all sails set, has been becalmed, say by some headland, but, suddenly passing out of this shelter, she is struck by the wind, which heels her over and continues to blow steadily for some time after its sudden application. Now inclination of the ship at once reduces the

moment of the wind-pressure on the sails. Turning to the section, Fig. 29, page 61, suppose P to be the pressure of the wind, acting horizontally and athwartships, let h be the height of its line of action above that of the equal and opposite fluid resistance P . Then *initially* the inclining moment of the wind on the sails will be given by the equation,

$$\text{Moment of sail power} = P \times h.$$

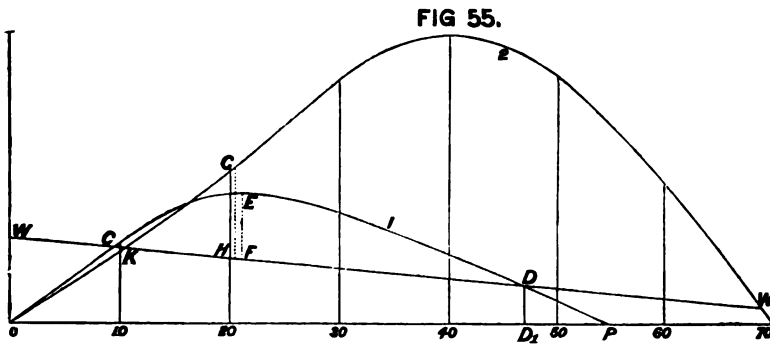
The sails are generally assumed to be flat surfaces lying in the plane of the masts. But the ship begins to heel as soon as the wind pressure begins to act, and for an inclination a we should have approximately,

$$\text{Moment of sail power} = P \times h \cos^2 a.$$

This law of decrease in the moment of the sails does not profess to be accurate, and is known to be very inaccurate for large angles of inclination; but it is generally accepted as sufficiently near the truth for practical purposes; and as it is chiefly used in *comparisons* between different ships, no injustice to any particular ship is involved in its adoption.

An illustration of the use of this curve of (cosines)², or "wind curve," is given in Fig. 55; it is marked WCDW. Two curves of stability (1 and 2), for the *Captain* and *Monarch* respectively, also appear in that diagram; but the ordinates represent statical moments of stability instead of simple GZ values, this arrangement being made in order that the comparison between the two ships may allow for their different displacements. It will be assumed that they have equal sail spread and moments of sail, so that one wind-curve will serve for both ships. The force of wind is supposed sufficient to hold the *Captain* at a steady heel of nearly 10 degrees, and the *Monarch* at a slightly greater heel. No matter how far the vessels become inclined, if the wind continues to act upon them, the part of the areas of the curves lying between the wind curve and the base-line will be absorbed in counterbalancing the steady pressure of the

wind. Hence only the areas lying above the wind curve are available to resist gusts or squalls; and these areas are therefore termed the "reserve dynamical stability." Supposing the reserve to be large, the ship is much safer than if it be small, and on reference to the diagram (Fig. 55) it will be seen how very small was the reserve in the *Captain* when compared with the *Monarch*. Lowness of freeboard associated with a moderate metacentric height contributed to give the ill-fated *Captain* a curve of stability of quite a different character from that of any other ship of war carrying masts and sails. Prior to her loss our information



respecting the curves of stability for various classes of ships was very meagre; but now that numerous and laborious investigations have been made, the very exceptional character of the *Captain* stands out clearly. Again referring to Fig. 47, the reader will see how far away from and beneath the curves of stability for all the other rigged ships is the curve for the *Captain*. In comparing her with the *Monarch*, as in Fig. 55, we have taken a rigged ship below the average as to the range of her stability, but even then the contrast is most remarkable. This will appear from the following statement, published, by authority, soon after the loss of the *Captain*, when many persons expressed fears, which were

groundless, that a similar catastrophe might happen to the *Monarch* :—

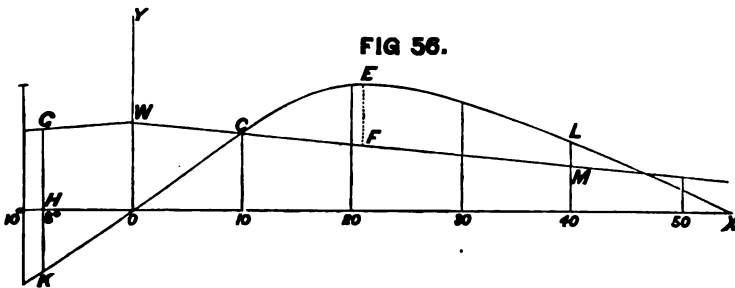
	<i>Monarch.</i>	<i>Captain.</i>
Angle at which the edge of the deck is immersed	28°	14°
Amount of righting force in the above position (in foot-tons of moment)	12,542	5,700
Angle of maximum stability	40°	21°
Maximum righting force (in foot-tons of moment)	15,615	7,100
Angle at which the righting force becomes zero (range of stability)	69½°	54½°
Reserve of dynamical stability at an angle of heel of 14 degrees (in foot-tons of work) . . .	6,500	410

The last comparison is the most important as regards safety, and from it one sees how small was the margin of safety of the *Captain* when sailing, as she is reported to have done on the day prior to her loss, at an angle of heel of 14 degrees. Adding to the wind pressure, the heave of the sea, and rolling oscillations, the reasons of the disaster are obvious.

Fig. 55 also furnishes an illustration of the method by which an approximation can be made to the maximum heel to which a ship is driven by a squall of wind having a certain force if her motion is unresisted. Let *WW* be the wind curve as before; the point *C*, where *WW* intersects the curve of stability (1) for the *Captain*, determines the steady heel corresponding to the assumed force of wind. The ship is *upright* when struck, and between the upright and the angle of steady heel the moment of sails continuously exceeds the statical righting moment; hence there is an unbalanced force throughout this part of the motion, storing up work (represented by the area *OWC*) which is afterwards expended in carrying on the ship until an inclination (*EF*) is reached (about 20 degrees in this case) making the area (*CEF*) above the wind curve equal to the area *WOC*. The *Monarch* would be driven over to nearly an equal angle by the same squall; *GH* marks the inclination, the area *GKH* being equal to the area *WOK*.

A still more critical case is that where the ship has just

completed a roll to windward when the squall strikes her. Accumulation of work then becomes far more serious; the righting moment and the moment of the sails act together as an unbalanced moment all the time that the vessel is moving back to the upright, the condition of things on the leeward side of the upright being similar to that already described. Fig. 56 illustrates this case for the *Captain*. The extreme angle of roll to windward, before the squall strikes the ship, is



indicated by the ordinate GHK (8 degrees); the ordinate LM marks the inclination (40 degrees) she must reach to leeward before the reserve of dynamical stability measured by the area CELMC can furnish the requisite amount of work to destroy the motion due to the accumulated work of roll and wind measured by the equal area GKOCWG.* This case shows that even in a calm sea a rigged ship of low freeboard may run great risk of being capsized if struck by a squall, and illustrates the great advantages possessed by vessels having a large reserve of dynamical stability. But it is in

* The wind curve is the same as in Fig. 55, the corresponding angle of steady heel being nearly 10 degrees; this curve will obviously be symmetrical about the upright position indicated by OY. On the windward side (to the left) of OY it will be noticed that the curve of stability is drawn below the base-line OX; the reason for so doing is that on the right-hand side (to leeward)

ordinates measured above the axis tend to make the vessel move back to windward, so that it is convenient to indicate the contrary tendency existing on the windward side (i. e. a tendency to drive the vessel back to leeward) by drawing the ordinates below the axis. No other feature in the diagram appears to require further explanation.

a seaway, where the heave of the sea and the action of the wind are combined, that by far the most serious dangers are encountered. On the other hand, it must be remembered that no account has been taken of fluid resistance, which would assist in checking the motion of the ship, and bring her up at a less inclination than the preceding methods would indicate.

Ships of the mastless type are less affected by the action of these suddenly applied squalls and gusts. Their broadsides do not offer sufficient surface to produce any sensible inclination in storms of ordinary severity. For instance, in the *Devastation* it is estimated that, with a storm of wind exerting a pressure of 100 lbs. per square foot, an inclination of only 5 degrees would be produced; but this pressure is about twice as great as that of a hurricane having a speed of 100 knots per hour. Hence a far more moderate range and area of the curves of stability is admissible for such vessels than is proper in rigged ships, and the Admiralty committee on designs recommended a range of 50 degrees as sufficient for such vessels, regarding them as safe even with a less range of stability.

CHAPTER V.

DEEP-SEA WAVES.

MANY attempts have been made to construct a mathematical theory of wave motion, and thence to deduce the probable behaviour of ships at sea; and the diversity of these theories affords ample evidence, if evidence were needed, of the difficulties of the subject. To an ordinary observer perhaps no phenomena appear less susceptible of mathematical treatment than the rapid and constant changes witnessed in a seaway; but it is now generally agreed that the modern or trochoidal theory of wave motion fairly represents the phenomena, while preceding theories do not. Without attempting any account of the earlier theories, it is proposed in the present chapter to endeavour, in a simple manner, to explain the main features of the trochoidal theory for deep-sea waves.

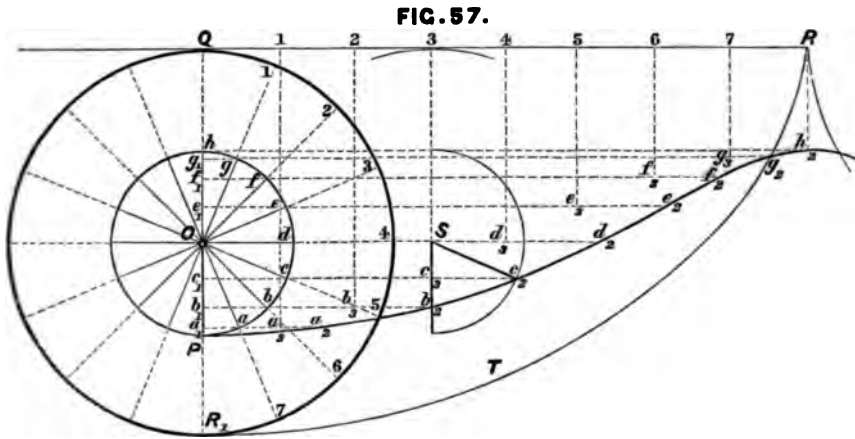
Let it be supposed that, after a storm has subsided, a voyager in mid-ocean meets with a series of waves all of which are approximately of the same form and dimensions; these would constitute a single, or independent, series such as the trochoidal theory contemplates. For all practical purposes, such waves may be regarded as traversing an ocean of unlimited extent, where the depth, in proportion to the wave dimensions, is so great as to be virtually unlimited also; these are the conditions upon which the theory is based. The bottom is supposed to be so deep down that no disturbance produced by the passage of waves can reach it; and the regular succession of the

waves requires the absence of boundaries to the space traversed. It is not supposed, however, that an ordinary sea-way consists of such a regular single series of waves; on the contrary, more frequently than otherwise two or more series of waves exist simultaneously, over-riding one another, and causing a "confused sea," successive waves being of unequal size and varying form. But sometimes the conditions assumed are fulfilled—a well-defined regular series of waves is met with; and from the investigation of their motions it is possible, as we shall see hereafter, to pass to the case of a confused sea. Nor is it supposed that only deep-sea waves are worthy of investigation; those occurring in shallower water also present notable features, but for our present purpose they are not nearly so important as ocean waves, since these latter so largely influence the behaviour of ships. It will be understood then that in what follows, unless the contrary is stated, we are dealing with a single series of regular deep-sea waves.

Any one observing such waves cannot fail to be struck with their apparently rapid advance, even when their dimensions are moderate. A wave 200 feet in length, from hollow to hollow, has a velocity of 19 knots per hour—faster than the fastest steam-ship—and such waves are of common occurrence. A wave 400 feet in length has a velocity of 27 knots per hour; and an Atlantic storm wave, 600 feet long, such as Dr. Scoresby observed, moves onward at the speed of 32 knots per hour. But it is most important to note that in all wave motion it is the *wave form* which travels at these high speeds, and not the particles of water. This assertion is borne out by careful observation and common experience. If a log of wood is dropped over-board from a ship, past which waves are racing at great speed, it is well known that it is not swept away, as it must be if the particles of water had a rapid motion of advance, and as it would be on a tideway where the particles of water move onwards; but it simply sways backward and forward as successive waves pass.



Before explaining this distinction between the motions of the particles in the wave and the motion of the wave form, it will be well to illustrate the mode in which, according to the modern theory, the wave form or profile may be constructed. Fig. 57 will serve this purpose. Suppose QR to be a straight line, under which the large circle whose radius is OQ is made to roll. The length QR being made equal to the semi-circumference, the rolling circle will have completed half a revolution during its motion from Q to R; and if this length QR and the semi-circumference QR_1 are each



divided into the same number of equal parts (numbered correspondingly 1, 2, 3, &c. in the diagram), then obviously, as the circle rolls, the points with corresponding numbers on the straight line and circle will come into contact successively, each with each. Next suppose a point P to be taken on the radius OR_1 of the rolling circle; this will be termed the "tracing point," and as the circle rolls, the point P will trace a curve (a trochoid, marked P, a_2 , b_2 , c_2 , \dots , h_2 in the diagram) which is the theoretical wave profile from hollow to crest, P marking the hollow and h_2 the crest. The trochoid may, therefore, be popularly described as the curve traced on a vertical wall by a marking-point fixed in one of the spokes of

a wheel, when the wheel is made to run along a level piece of ground at the foot of the wall ; but when thus described, it would be inverted from the position shown in Fig. 57.

To determine a point on the trochoid is very simple. As the rolling circle advances, a point on its circumference (say 3) comes into contact with the corresponding point of the directrix-line QR ; the centre of the circles must at that instant be (S) vertically below the point of contact (3), and the angle through which the circular disc and the tracing arm OP have both turned is given by QO3. The angle POc, on the original position of the circles, equals QO3 ; through S draw Sc₂ parallel to Oc, and make Sc₂ equal to Oc ; then c₂ is a point on the trochoid. Or the same result may be reached by drawing c₃ horizontal, finding its intersection (c₃) with the vertical line S3, and then making c₂c₃ equal to c₁. In algebraical language, this may be simply expressed. Take Q as the origin of co-ordinates, QR for axis of abscissæ (x).

Let radius OQ = a,

„ OP = b,

angle QO3 = θ ,

and x, y co-ordinates of point c₂ on trochoid.

Then

$$\begin{aligned} x = c_1c_2 &= c_1c_3 + c_2c_3 \\ &= a\theta + b \sin \theta ; \end{aligned}$$

$$\begin{aligned} y = c_1Q &= OQ + Oc_1 \\ &= a + b \cos \theta. \end{aligned}$$

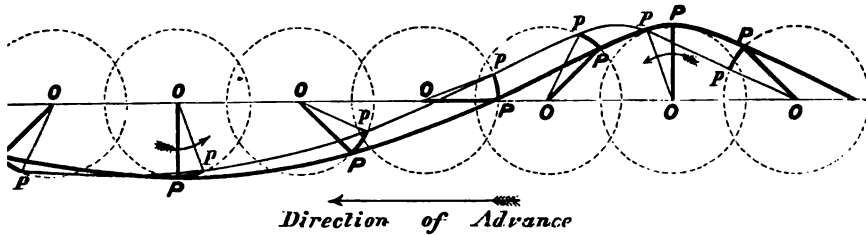
The tracing arm (OP) may, for wave motion, have any value not greater than the radius of the rolling circle (OQ). If OP equals OQ, and the tracing point lies on the circumference of the rolling circle, the curve traced is termed a *cycloid*, and corresponds to a wave on the point of breaking. The curve R₁TR, in Fig. 57, shows a cycloid, and it will be noticed that the crest is a sharp ridge or line (at R), while the hollow is a very flat curve.

A few definitions must now be given of terms that will be frequently used hereafter. The *length* of wave is its measure-

ment (in feet usually) from crest to crest, or hollow to hollow—QR in Fig. 57 would be the half-length. The *height* of a wave is reckoned (in feet usually) from hollow to crest; thus in Fig. 57, for the trochoidal wave, the height would be Ph —twice the tracing arm. The *period* of a wave is the time (usually in seconds) its crest or hollow occupies in traversing a distance equal to its own length; and the velocity (in feet per second) will, of course, be obtained by finding the quotient of the length divided by the period, and would commonly be determined by noting the speed of advance of the wave crest.

Accepting the condition, that the profile of an ocean wave is a trochoid, the motion of the particles of water

FIG. 58.



in the wave requires to be noticed, and it is here the explanation is found of the rapid advance of the wave form, while individual particles have little or no advance. The trochoidal theory teaches that every particle revolves with uniform speed in a circular orbit (situated in a vertical plane which is perpendicular to the wave ridge), and completes a revolution during the period in which the wave advances through its own length. In Fig. 58, suppose P, P, P, &c. to be particles on the upper surface, their orbits being the equal circles shown: then for this position of the wave the radii of the orbits are indicated by OP, OP, &c. The arrow below the wave profile indicates that it is advancing from right to left; the short arrows on the circular orbits show that at the wave crest the particle is moving in the same direction as the wave is advancing in, while at the

hollow the particle is moving in the opposite direction. It need hardly be stated again that for these surface particles the diameter of the orbits equals the height of the wave. Now suppose all the tracing arms OP , OP , &c. to turn through the equal angles POp , POp , &c.: then the points p , p , p , &c. must be corresponding positions of particles on the surface formerly situated at P , P , &c. The curve drawn through p , p , p , &c. will be a trochoid identical in form with P , P , P , &c., only it will have its crest and hollow further to the left; and this is a motion of advance in the wave form produced by simple revolution of the tracing arms and particles (P).^{*} The motion of the particles in the direction of advance is limited by the diameter of their orbits, and they sway to and fro about the centres of the orbits. Hence it becomes obvious why a log dropped overboard, as described above, does not travel away on the wave upon which it falls, but simply sways backward and forward. One other point respecting the orbital motion of the particles is noteworthy. This motion may be regarded at every instant as the resultant of two motions—one vertical, the other horizontal—except in four positions, viz.: (1) when the particle is on the wave crest; (2) when it is in the wave hollow; (3) when it is at mid-height on one side of its orbit; (4) when it is at the corresponding position on the other side. On the crest or hollow the particle instantaneously moves horizontally, and has no vertical motion. At mid-height it moves vertically, and has no horizontal motion. Its maximum horizontal velocity will be at the crest or hollow; its maximum vertical velocity at mid-height. Hence uniform motion along the circular orbit is accompanied by accelerations and retardations of the component velocities in the horizontal and vertical directions.

The particles which lie upon the trochoidal upper surface

^{*} It is possible to construct a very simple apparatus by which the simultaneous revolution of a series of particles will produce the apparent motion of advance; and in lectures delivered at the Royal Naval College such an apparatus was used by the Author.

of the wave are situated in the level surface of the water when at rest. The disturbance caused by the passage of the wave must extend far below the surface, affecting a great mass of water. But at some depth, supposing the depth of the sea to be very great, the disturbance will have practically ceased: that is to say, still, undisturbed water may be conceived as underlying the water forming the wave; and reckoning downwards from the surface, the extent of disturbance must decrease according to some law. The trochoidal theory expresses the law of decrease, and enables the whole of the internal structure of a wave to be illustrated in the manner shown in Fig. 59.* On the right-hand side of the line AD the horizontal lines marked 0, 1, 2, 3, &c. show the positions in still water of a series of particles which during the wave transit assume the trochoidal forms numbered respectively 0, 1, 2, 3, &c. to the left of AD. For still water every unit of area in the same horizontal plane has to sustain the same pressure: hence a horizontal plane would be termed a surface or subsurface of "equal pressure," when the water is at rest. As the wave passes, the trochoidal surface corresponding to that horizontal plane will continue to be a subsurface of equal pressure; and the particles lying between any two planes (say 6 and 7) in still water will, in the wave, be found lying between the corresponding trochoidal surfaces (6 and 7).

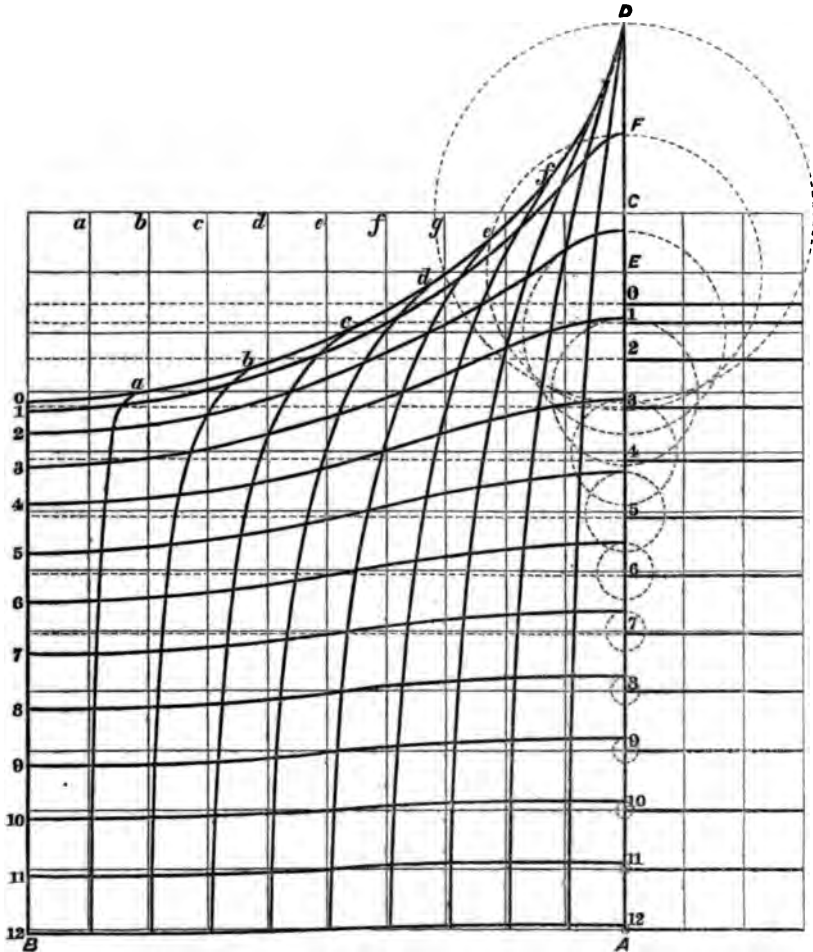
In Fig. 59, it will be noticed that the level of the still-water surface (0) is supposed changed to a *cycloidal* wave (0), the construction of which has already been explained; this is the limiting height the wave could reach without breaking. The half-length of the wave AB being called L, the radius (CD) of the orbits of the surface particles will be given by the equation,

$$CD = R = \frac{L}{\pi} = \frac{7}{22} L \text{ (nearly).}$$

* This diagram we borrow from Institution of Naval Architects for Mr. Froude's paper on "Wave Motion" in the *Transactions* of the 1862; it was one of the first constructed, and is therefore reproduced.

All the trochoidal subsurfaces have the same length as the cycloidal surface, and consequently they are all generated by the motion of a rolling circle of radius R ; but their

FIG. 59.



tracing arms—measuring half the heights from hollow to crest—rapidly decrease with the depth (as shown by the dotted circles), the trochoids becoming flatter and flatter in

consequence. The crests and hollows of all the subsurfaces are vertically below the crest and hollow of the upper wave profile. The heights of these subsurfaces diminish in a geometrical progression, while the depth increases in arithmetical progression; and the following approximate rule is very nearly correct. The orbits and velocities of the particles of water are diminished by *one-half*, for each additional depth below the mid-height of the surface wave equal to *one-ninth* of a wave length.* For example—

Depths in fractions of a wave length below	}	0, $\frac{1}{9}$, $\frac{2}{9}$, $\frac{3}{9}$, $\frac{4}{9}$, &c.
the mid-height of the surface wave		
Proportionate velocities and diameters	.	1, $\frac{1}{2}$, $\frac{1}{4}$, $\frac{1}{8}$, $\frac{1}{16}$, &c.

Take an ocean storm wave 600 feet long and 40 feet high from hollow to crest: at a depth of 200 feet below the surface ($\frac{2}{3}$ of length), the subsurface trochoid would have a height of about 5 feet; at a depth of 400 feet ($\frac{4}{3}$ of length) the height of the trochoid—measuring the diameter of the orbits of the particles there—would be about 7 or 8 inches only; and the curvature would be practically insensible on the length of 600 feet. This rule is sufficient for practical purposes, and we need not give the exact exponential formula expressing the variation in the radii of the orbits with the depth.

It will be noticed also in Fig. 59 that the centres of the tracing circles corresponding to any trochoidal surface lie above the still-water level of the corresponding horizontal plane. Take the horizontal plane (1), for instance. The height of the centre of the tracing circle for the corresponding trochoid (1) is marked E, EF being the radius; and the point E is some distance above the level of the horizontal line 1. Suppose r to be the radius of the orbits for the trochoid under consideration, and R the radius of the rolling

* See page 70 of *Shipbuilding, Theoretical and Practical*, edited by the late Professor Rankine; who,

with Mr. Froude, has done much to develop the trochoidal theory.

circle: then the centre (E) of the tracing circle (i.e. the mid-height of the trochoid) will be above the level line (1) by a distance equal to $\frac{r^2}{2R}$. Now R is known when the length

of the wave is known: also r is given for any depth by the above approximate rule. Consequently, the reader will have in his hands the means of drawing the series of trochoidal subsurfaces for any wave that may be chosen.

Columns of particles which are vertical in still water become curved during the wave passage; in Fig. 59, a series of such vertical lines is drawn (see the *fine* lines $a, b, c, d, \&c.$); during the wave transit these lines assume the positions shown by the strong lines ($a, b, c, d, \&c.$) curving towards the wave crest at their upper ends, but still continuing to inclose between any two the same particles as were inclosed by the two corresponding lines in still water. The rectangular spaces inclosed by these vertical lines ($a, b, c, d, \&c.$) and the level lines (0, 1, 2, &c.) produced are changed during the motion into rhomboidal-shaped figures, but remain unchanged in area. Very often the motions of these originally vertical columns of particles have been compared to those occurring in a corn-field, where the stalks sway to and fro, and a wave form travels across the top of the growing corn. But while there are points of resemblance between the two cases, there is also this important difference—the corn-stalks are of constant length, whereas the originally vertical columns become elongated in the neighbourhood of the wave crests, and shortened near the wave hollows.

These are the chief features in the internal structure of a trochoidal wave, and in the following chapter they will be again referred to in order to explain the action of waves upon ships. It is necessary, however, at once to draw attention to the fact that the conditions and direction of fluid pressure in a wave must differ greatly from those for still water. Each particle in the wave, moving at uniform speed in a circular orbit, will be subjected to the action of centrifugal force as well as the force of gravity; and the resultant

of these two forces must be found in order to determine the direction and magnitude of the pressure on that particle. This may be simply done as shown in Fig. 60 for a surface particle in a wave. Let BED be the orbit of the particle; A its centre; and B the position of the particle in its orbit at any time. Join the centre of the orbit A with B ; then the centrifugal force acts along the radius AB , and the length AB may be supposed to represent it. Through A draw AC vertically, and make it equal to the radius (R) of the rolling circle; then AC will represent the force of gravity on the same scale as AB does that of centrifugal force. Join BC , and it will represent in magnitude and direction the resultant of the two forces acting on the particle. Now it is an established property of a fluid that its free surface will place itself at right angles to the resultant force impressed upon it. For instance, take the simple case of a rectangular box (shown in Fig. 61) con-

FIG 60.

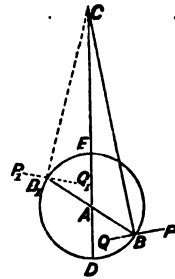
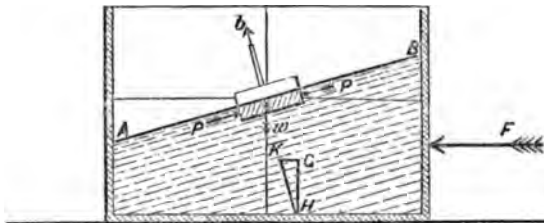


FIG 61.



taining water, which is made to move along a smooth horizontal plane by the continued application of a force F ; then we shall have uniformly accelerated motion, equal increments of velocity being added in successive units of time.* In order to compare this force with that of gravity,

* See remarks on this subject at page 106 of Chapter IV.

if f is the velocity added per second of time, and W is the weight of the box and water, we should have,

$$\frac{F}{W} = \frac{f}{g} = \frac{f}{32\frac{1}{2}} \text{ (nearly).}$$

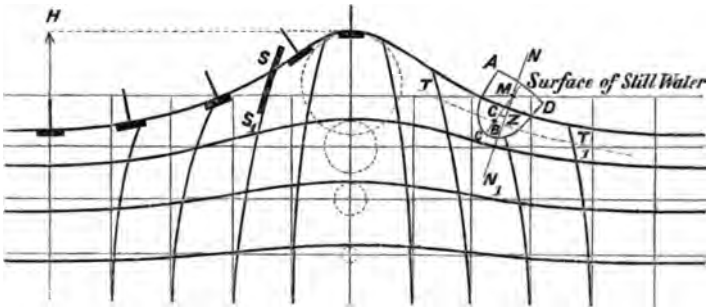
Now it is well known that under the assumed circumstances of motion the surface of the water in the box will no longer remain level, but will attain some definite slope such as AB in Fig. 61; and it is easy to ascertain the angle of slope. Through any point G draw GH vertical to represent the weight W , and GK horizontal to represent the force F ; join HK , and it will represent the resultant of the two forces, the water surface AB placing itself perpendicular to the line, on the principle mentioned above.*

Reverting to Fig. 60, the resultant pressure shown by BC must be normal to that part of the trochoidal surface PQ where the particle B is situated. Similarly, for the position B_1 , CB_1 will represent the resultant force; P_1Q_1 , drawn perpendicularly to CB_1 , being a tangent to the trochoid at B_1 . Conversely, for any point on any trochoidal surface in a wave, the direction of the fluid pressure must lie along the *normal* to that surface. Hence it follows that wave motion involves constant changes in the magnitude and direction of the fluid pressure for any trochoidal surface; these changes of direction partaking of the character of a regular oscillation keeping time with the wave motion. At the wave hollow the fluid pressure acts along a vertical line; as its point of application proceeds along the curve, its direction becomes more and more inclined to the vertical, until it reaches a maximum inclination at the point of inflexion of the trochoid; thence onwards towards the crest the direction of the normal pressure is constantly decreasing until at the crest it is once more vertical. If a small raft

† If α be the angle of inclination of the surface to the horizon: then
 $\tan \alpha = \frac{F}{W}$.

floats on the wave (as shown in Fig. 62), it will at every instant place its mast in the direction of the resultant fluid pressure, and in the diagram several positions of the raft are indicated to the left of the wave crest. These motions of the direction of the normal to the trochoid may be compared with those of a pendulum, performing an oscillation from an angle equal to the maximum inclination of the normal on one side of the vertical to an equal angle on the other side, and completing a single swing during a period equal to half the wave period.

FIG. 62.



The maximum slope of the wave to the horizon occurs at a point somewhat nearer the crest than the hollow, but no great error is assumed in supposing it to be at mid-height in ocean waves of common occurrence where the radius of the tracing arm (or half-height of the wave) is about one-twentieth of the length. For this maximum slope, we have

$$\begin{aligned} \text{Sine of angle} &= \frac{\text{radius of tracing circle}}{\text{radius of rolling circle}} \\ &= \frac{\text{half-height of wave}}{\text{length of wave} \div 6.2832} \\ &= 3.1416 \times \frac{\text{height of wave}}{\text{length of wave}} \end{aligned}$$

For waves of ordinary steepness all practical purposes are

served by writing the circular measure of the angle instead of the sine; hence ordinarily we may say,

$$\left. \begin{array}{l} \text{Approximate maximum wave} \\ \text{slope (in degrees) . . .} \end{array} \right\} = 180^\circ \times \frac{\text{height of wave}}{\text{length of wave}}$$

Take, as an example, a wave for which the dimensions were actually determined in the Pacific, 180 feet long and 7 feet high :

$$\text{Maximum slope} = 180^\circ \times \frac{7}{180} = 7^\circ \text{ (nearly).}$$

The variation in the direction of the normal was in this case equivalent to an oscillation of a pendulum swinging 7 degrees on either side of the vertical once in every half-period of the wave—some 3 seconds. These constant and rapid variations in the direction of the fluid pressure in wave water constitute the chief distinction between it and still water, where the resultant pressure on any floating body always acts in one direction, viz. the vertical.

But it is also necessary to notice that in wave water the *intensity* as well as the direction of the fluid pressure varies from point to point. Reverting to Fig. 60, and remembering that lines such as BC represent the pressure in magnitude as well as direction, we can at once compare the extremes of the variation in intensity. In the upper half of the orbit of a particle, centrifugal force acts *against* gravity, and reduces the weight of the particle; this reduction reaches a maximum at the wave crest, when the resultant is represented by CE ($R - r$). In the lower half of the orbit, gravity and centrifugal force act together, producing a virtual increase in the weight of each particle; the maximum increase being at the wave hollow, where the resultant is represented by CD ($R + r$). If a little float accompanies the wave motion, it may be treated as if it were a particle in the wave, and its apparent weight will undergo similar variations. In a ship, heaving up and down on waves very large as compared with herself, the same kind of variations will occur, though

perhaps not to the same extent as in the little float. Actual observation shows this to be true. Captain Mottez, of the French navy, reports that on long waves about 26 feet high the apparent weights at hollow and crest had the ratio of 12 to 8. According to the preceding rules we must then have,

$$\frac{R-r}{R+r} = \frac{8}{12},$$

$$\frac{2R}{2r} = \frac{20}{4},$$

$$R = 5r = 5 \times 13 = 65 \text{ feet.}$$

Length of waves (by theory) = $2\pi R = 6.28 \times 65 = 408$ feet.

This, in proportion to the height recorded, is not an unreasonable length; but, unfortunately, Captain Mottez does not appear to have completed the information required, by measuring the actual length of the waves. The important fact he proved, however, is one that theory had predicted, viz. that the heaving motion of the waves may produce a virtual variation in the weight of a ship equivalent to an increase or decrease of one-fourth or one-fifth, when the proportions of the height and length of the waves are those common at sea.

Instead of the raft in Fig 62, if the motions of a loaded pole or plank on-end (such as SS) be traced, it will be found that it tends to follow the originally vertical lines, and to roll always toward the crest as they do. Here again the motion partakes of the nature of an oscillation of fixed range performed in half the wave period, the pole being upright at the hollow and crest.

A ship differs from both the raft and the pole; for she has both lateral and vertical extension into the subsurfaces of the wave, and cannot be considered to follow either the motion of the surface particles like the raft or of an originally vertical line of particles like the pole. This case will be discussed in the next chapter.

As a mathematical theory, that for trochoidal waves is complete and satisfactory, under the conditions upon which it is based; but sea-water is not a *perfect fluid* such as the theory contemplates; in it there exists a certain amount of viscosity, and the particles must experience resistance in changing their relative positions. There is every reason to believe that the theory closely approximates to the phenomena of deep-sea waves, but it is very desirable that extensive and accurate observations of the dimensions and speeds of actual waves should be made, in order to test the theory, and determine the closeness of its approximation to truth. The recorded observations on waves are not so complete or numerous as to furnish the test required; and by adding to them during their service at sea, naval officers will do much to advance one important branch of the science of naval architecture. The Lords Commissioners of the Admiralty have recently issued orders that careful observations of waves shall be made in her Majesty's ships, simultaneously with the observations of rolling; so that the relations between the state of the sea and the behaviour of the ships may be more readily discovered. In the French navy similar observations have been made, and the published results are very valuable.* Mr. Froude has furnished to the Admiralty a memorandum on the method of determining at sea, by simple observation, the periods and dimensions of waves; and the importance of correctness in making such observations renders it desirable to introduce here a reprint of the official method of observation in the Royal Navy. It should be premised, however, that no test of the theory can be applied by means of observations made in a confused sea; it is when a ship falls in with a series of waves of nearly regular form and period that the

* See a paper on "The Experimental Study of Waves," by M. Bertin, in the *Transactions* of the Institution of Naval Architects for

1873; and memoirs by M. Antoine, of Brest (analysing the results of various observations), Lieutenant Paris, and others.

observations become most valuable from a scientific point of view. A regular series is that which is most likely to produce the heaviest rolling in a ship exposed to its action; and for these reasons the greatest attention should be devoted to observations of regular series of waves. It is not, however, desirable that only such observations should be made; for much light might be thrown upon the question of the superposition of series of waves, if the phenomena of a confused sea were carefully noted. Moreover, the actual determination of the dimensions of the solitary waves of exceptional size, as compared with neighbouring waves, of which all sailors speak, would furnish very interesting and much needed information. Supposing a single series of waves to be encountered, the following is a reprint of the most important parts of the—

**METHOD OF OBSERVING THE DIMENSIONS AND PERIODS
OF WAVES PROPOSED BY MR. FROUDE AND APPROVED
BY THE ADMIRALTY.**

The method of observation to be adopted on board a ship for the purpose of determining the periods and dimensions of the waves she encounters will naturally be somewhat different accordingly as the ship is (1) stationary, or (2) in motion. If she be stationary, the wave period may be at once determined by a single observer, noting successively the moment at which successive wave crests pass the particular part of the ship on which he stands.

In describing the observations by which the length of wave is to be determined, it is convenient to assume first that the ship is "end-on" to the wave crests. If the length of the wave be less than that of the ship, two observers should watch two consecutive wave crests which are rolling past the ship—one, one; the other, the other; and should each simultaneously, on the word being given to them, notice the position on the ship's side occupied by the wave he is

watching. The interval between the positions when measured on the ship's deck is simply the wave length.

If the length of the wave be greater than the ship's length, the process is less simple.

Let a convenient length (the greater the better) be set out along the ship's deck; and at each end of the line, transversely to it, let a pair of battens be erected so as to define, when used as sights, a pair of parallel lines at right angles to the ship's keel, the interval between them being the length measured out on the deck; and let an observer be stationed at each, say No. 1 at the end of the line which the waves first meet, No. 2 at the other.

Let observer No. 1 note the instant of time when a wave crest passes the line of sight marked by his pair of battens; and let observer No. 2 note it when the same wave crest passes the line marked by his; and let the observation be repeated for the succeeding wave crest by one or other of the observers.

This latter observation at once fixes the period of the wave, as has already been mentioned.

If the times noted by observers No. 1 and No. 2 be compared, the difference will give the time occupied by the observed wave crest in passing the interval between the two parallels. The time occupied by the crest in passing this known interval defines the speed of the wave.

Thus, the period being known and the speed being known, the length may be immediately deduced, since it is the distance which the wave having that speed will traverse in the period.

If the ship, though stationary, be not end-on to the waves, but deviate from that position by a known angle, the values of the speed and length of the wave thus deduced will be alike too great, but they will give the true values when multiplied by the cosine of the deviation.

If the ship be not stationary, but moving with a known speed, it is convenient to assume as before that she is end-on to the waves, her motion being also end-on to them, so that she is either running exactly before the sea or is exactly heading it.

Under these circumstances the same observations are to be made as already mentioned; but the period, speed, and length, primarily deduced from them require the following corrections:—

The time which elapses between the transits of two consecutive wave crests past observer No. 1 or No. 2 is greater or less than the true period, because the distance actually travelled by the wave during the time is greater or less than the true wave length by the distance travelled in the meantime by the ship, either *from* the waves or *towards* the waves. But as the speed of the ship is known, the true speed of the wave may be at once inferred from its apparent speed as primarily deduced from the observations, by adding to it, or deducting from it, the speed of the ship, according as she is running before the waves or heading them; and by help of this correction the true wave length and true wave period may be readily found.

The process of correction may best be expressed algebraically—

If V be the speed of the ship, in feet per second.

L the interval between the parallel lines defined by the battens, in feet.

V the speed of the wave, in feet per second.

L the length of the wave, in feet.

P the period of the wave, in seconds.

Then, if the time occupied by the wave crest in passing over L be (t) in seconds, it follows that

$$V = \frac{L}{t} \pm V.$$

And if the observed time between the transits of two successive wave crests past observer No. 1 or No. 2 be (t), it follows that

$$L = (V \pm V) t \text{ and}$$

$$P = \frac{L}{V}.$$

If the course of the ship be not on a line at right angles to the wave crest, but deviate from it by a given angle, here also, as in the former case, the same observations must be made, and these must primarily be treated in the same manner as if the course had not been oblique. And here also the apparent wave length and wave speed thus deduced will be too great, but will yield the true values when multiplied by the cosine of the deviation.

Wave heights are less easy to determine by ordinary observation, at least on board a high-sided ship. But when they are such that, if the ship is in the trough of the sea, the nearest wave crests hide the distant horizon from the eye of an observer standing on deck, he may, by ascending the rigging or otherwise, place himself at such a height that the successive average ridge levels, as viewed by him from the trough, just reach the line of the horizon without obscuring it. And if he measures, or carefully estimates, the height of his eye above the water, that height is correctly the height of the wave.

This height is *prima facie* determined by the distance from the point of observation to the plane of the ship's natural water-line. But it must be borne in mind that in pitching and 'scending the head or stern of the ship, when the wave hollow passes it, is often immersed far deeper than the natural water-line, and the observer must make due allowance for this if he be stationed forward or aft; and though, by invariably posting himself in the ship's waist, he will avoid the necessity of making so large a correction, yet even thus, when a ship, end-on to the waves, is in the middle of the trough, the curvature of the wave hollow gives extra immersion to her two ends, and the water surface amidships is somewhat below her natural water-line. Due allowance must also be made for changes of level occasioned by rolling or heeling.

If the waves are not high enough to be observed in this manner, they may be more exactly gauged by the following apparatus, which, however, is somewhat awkward to handle.

The principle on which its application rests shall first be described.

It is well known that the amount of motion in the water of which a wave consists declines very rapidly as it is traced to greater and greater depths below the surface, the rate of declension being governed by the ratio of the depth below the surface to the length of the wave ; so much so that at a depth equal to the length of the wave the motion, whether horizontal or vertical, is less than $\frac{1}{300}$ part of what it is at the surface, and the water may be regarded as practically undisturbed. Advantage may be taken of this undisturbed water as a basis from which to measure the undulations at the surface, in the following manner.

Let a light, tapered spar be prepared, of a length about four times the height of the highest wave to be observed, and of as small a diameter as its length permits, with a view to both safety and facility of handling ; and let it be painted from its smaller end downwards, in divisional spaces of, say, 2 feet each, alternately black and white, with distinguishing marks in red and blue to assist an observer in counting the spaces from a distance.

This pole, when in use, is "anchored" (in a manner presently to be described) by its foot or larger end to the undisturbed subjacent water, with, say, a deep-sea line as "cable," and stands upright like the stem of a hydrometer, the weight and quasi-fixedness of the so-called "anchor" serving at once to keep the pole perpendicular and to maintain its summit at a definite elevation, about one quarter of its entire length, above the mean sea-level.

For the "anchor" let a light frame, such as is shown in Fig. 63, about 4 feet square, be formed of painted hard wood, such as will not readily become water-soaked, and let canvas or sheet-iron be tightly stretched

FIG 63.



over it and securely nailed to the edges. Let four stout lines be secured to its four corners, forming a quadruple bridle, the four parts of which, as sketched, are united upwards, centrally, in the deep-sea line which forms the "cable," and downwards in a bight, or hook, to which the requisite ballast can be attached.

The other end of the line must be secured to the foot of the pole, with such a length or scope as to allow the frame to sink to the undisturbed water, at a depth equal to not less than the length of the longest wave which affects the surface. The weight of ballast attached must be such as to sink the frame and hold down the pole to the required immersion.

This adjustment may be made with the line at short scope; but then it will be observed that the apparatus, having hold of the water at but a short depth below the surface, will rise and fall with the larger waves, while the shorter and comparatively shallow waves will wash up and down the pole.

Care should be taken not to under-estimate the length of long low waves. These are frequently so low as to be too undistinguishable for measurement of length or period in the manner described, especially when the surface is confused by the presence of smaller waves. Yet these long, low, and almost invisible waves are objects of great interest, and are very deserving of observation, because it is generally in virtue of their perhaps unsuspected operation that a large ship is occasionally found to roll with surprising range and persistence, when no adequate cause for this presents itself; though probably an entirely sufficient cause would be found to exist in the fact, which the observations here suggested can alone sufficiently disclose, that these unseen waves exist and possess a period the same as that of the ship. It is not safe to assume their length as less than 600 or 700 feet.

When the apparatus is to be used, the weighted frame must first be lowered into the water, and allowed to sink gradually; then the pole must be got overboard and allowed to adjust its immersion to the load it carries. So soon as it

has thus settled itself, the waves at the surface will be seen to rise and fall up and down its side, just as if it were the standard of a fixed beacon, it being (as has been said) in effect anchored in the undisturbed water below, and the levels reached by the wave ridges and wave hollows on the painted divisional spaces may be read off, and the wave period noted with ease and exactness, if the ship which carries the observer be kept pretty close to the pole. It must be borne in mind, in using this apparatus, that, in spite of all precautions, if it is kept very long in the water, both the pole, the line, and the frame, will become gradually water-soaked, and, therefore, the pole more and more immersed, so that it may eventually sink altogether, since the reserve of flotation is not large; but if the wood has been well painted, it will allow probably a couple of hours' observation.

[END OF THE MEMORANDUM OF MR. FROUDE.]

Other methods of observing the dimensions of waves have been devised and used; some of them, like the machine designed by Admiral Paris, of the French navy, being automatic in their action, and giving a continuous record of the heights of the wave profile at every instant upon the scale of measurement. When the waves are not high enough to use the method of horizon observation, it is necessary that any other method of measuring heights should refer them in some manner, as is done in the preceding memorandum, to the level of the practically still water underlying the water disturbed by the wave motion. Lengths and periods of waves are easily determined when a single series is encountered, but the correct observation of heights is far more difficult; and it is here that probably the greatest exaggerations have occurred in statements of the dimensions. Waves "mountain-high" have passed into a proverb, but they cannot be discovered in any trustworthy record, and probably never existed in the deep sea.

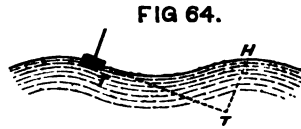
In justification of this statement it may be well to briefly

summarise the principal dimensions of the largest waves of which we have any trustworthy accounts. The longest wave observed was measured by Captain Mottez, of the French navy, in the North Atlantic, and had a length of 2720 feet—half a mile—from crest to crest; its period was 23 seconds. In the South Atlantic, Sir James Ross observed a wave 1920 feet long. The largest waves observed in European waters are said to have had a period of $19\frac{3}{4}$ seconds, corresponding to a theoretical length of some 2000 feet; in the Bay of Biscay waves have been noted having a length of 1320 feet. These monster waves are not, however, commonly encountered, and waves having a length of 600 to 700 feet would ordinarily be regarded as large waves. Dr. Scoresby's largest Atlantic storm waves had lengths of about 500 to 600 feet, and periods from 10 to 11 seconds. According to the best authorities, ocean waves of 24 seconds' period, and some 3000 feet in length, may be taken as the extreme limit of size yet proved to exist; waves of 18 seconds' period, and about 1650 feet in length, constitute the upper limit in all except extraordinary cases; and what may be called common large storm waves have periods varying from 6 to 9 seconds, the corresponding lengths varying from 200 to 400 feet.

Turning next to heights, we find reports of estimated heights of 100 feet from hollow to crest, but no verified measurement exists of a height half as great as this. The highest trustworthy measurements are from 44 to 48 feet—in itself a very remarkable height. Scoresby and others have measured heights of about 40 feet, and there are several records of heights exceeding 30 feet. Waves having a greater height than 30 feet are not commonly encountered. All these figures, be it understood, refer to a single series of waves, and not to one or more series superposed on one another, nor to any great local rise of level due to the waves driving against a shore, or passing over an isolated rock.

An explanation of the causes of unintentional exaggeration in the estimate of wave heights will at once suggest itself

when the variation in the direction of the normal to the wave slope (previously explained) is taken into account. To an observer standing on the deck of a ship which is rolling amongst waves, nothing is more difficult than to determine the true vertical direction, along which the height of the wave must be measured. If he stands on the raft shown in Fig. 64, he will, like it, be affected by the wave motion; and the *apparent* vertical at any instant will be coincident with the masts of



the raft and normal to the wave slope. He will therefore suppose himself to be looking horizontally when he is really looking along a line parallel to the tangent to the wave slope at that point, which may be considerably inclined to the horizon. Suppose TT , Fig. 64, to represent this line for any position: then the apparent height of the waves to an observer will be HT , which is much greater than the true height. If the observer stands on the deck of a ship, the conditions will be similar; the normal to what is termed the "effective wave slope"* determines the apparent vertical at any instant; and the only easy way of determining the true horizontal direction is by making an observation of the horizon as described above. The extent of the possible error thus introduced will be seen from an example. Take a wave 250 feet long and 13 feet high; its maximum slope to the horizontal is about 9 degrees. Suppose a ship to be at the mid-height between hollow and crest, and the observer to be watching the crest of the next wave; standing about the water level, the wave height will seem to be about 30 feet instead of 13 feet. The steeper the slope of the waves, the greater liability is there to serious errors in estimates of heights, unless proper means are taken to determine the true horizontal and vertical direction. In some cases the apparent height would be about three times

* This phrase will be explained in the succeeding chapter.

the real height. This is a matter of very great importance to naval officers, not merely as regards the height of waves, but also the behaviour of ships.

Next as to the ratio of the heights to the lengths observed in deep-sea waves. All authorities agree that, as the lengths increase, this ratio diminishes, and the wave slope becomes less steep. The shortest waves are the steepest; and the greatest recorded inclinations are for very short waves where the ratio of height to length was about 1 to 6. For a cycloidal wave it will be remembered that the ratio is about 1 to 3·14; so that in the steepest deep-sea waves observed this ratio is only about one-half that of the theoretical limiting case. For waves from 330 to 350 feet in length, the ratio of 1 to 8 has been observed, but these were probably exceptionally steep waves; for waves of 500 to 600 feet in length, it falls to about 1 to 20; and for the longest waves, of uncommon occurrence, it is said to fall so low as 1 to 50. But it is obvious that all measurements of such gigantic waves must be attended with great difficulties, so that the results, even when the greatest care is taken, are only receivable as fair approximations. It seems probable that, in waves of the largest size commonly met, the height does not exceed one-twentieth of the length; and the higher limit of steepness in ocean waves, which are large enough to considerably influence the behaviour of ships, does not give a ratio of height to length exceeding 1 to 10. Long series of observations made in ships of the French navy show that a common value of the height is about one-twenty-fifth or one-thirtieth of the length. Waves from 500 to 900 feet in length are sometimes encountered, having heights of from 5 to 10 feet only. Hereafter it will be seen that the decrease of steepness accompanying an increase in length and period is a most fortunate circumstance for the good behaviour of ships at sea.

The trochoidal theory connects the periods and speeds of waves with their length alone, and does not take any account of the height, except to fix the limiting ratio of height to

length in a cycloidal wave. The principal formulæ for lengths, speeds, and periods for trochoidal waves are as follows:—

$$\begin{aligned} \text{I. Length of wave (in feet)} &= 5.123 \times \text{square of period (in seconds)} \\ &= 5\frac{1}{8} \times \text{square of period (nearly)}. \end{aligned}$$

$$\begin{aligned} \text{II. Speed of wave (in feet per second)} &\left. \begin{array}{l} \\ \\ \end{array} \right\} = 5.123 \times \text{period} \\ &= \sqrt{5.123 \times \text{length}} \\ &= 2\frac{1}{4} \sqrt{\text{length}} \text{ (nearly)}. \end{aligned}$$

$$\text{III. Speed of wave (in knots per hour)} \left. \begin{array}{l} \\ \end{array} \right\} = 3 \times \text{period (roughly)}.$$

$$\text{IV. Period (in seconds)} = \sqrt{\frac{\text{length}}{5.123}} = \frac{4}{9} \sqrt{\text{length}} \text{ (nearly)}.$$

$$\begin{aligned} \text{V. Orbital velocity of particles on surface} &\left. \begin{array}{l} \\ \\ \end{array} \right\} = \left\{ \begin{array}{l} \text{speed of} \\ \text{wave} \end{array} \right\} \times \frac{3.1416 \times \text{height of wave}}{\text{length of wave}} \\ &= 7\frac{1}{8} \times \frac{\text{height of wave}}{\sqrt{\text{length of wave}}} \text{ (nearly)}. \end{aligned}$$

To illustrate these formulæ, we will take the case of a wave 400 feet long and 15 feet high. For it we obtain,

$$\text{Period} = \frac{4}{9} \sqrt{400} = 8\frac{8}{9} \text{ seconds.}$$

$$\begin{aligned} \text{Speed} &= \frac{9}{4} \sqrt{400} = 45 \text{ feet per second} \\ &= 3 \times 8\frac{8}{9} = 26\frac{2}{3} \text{ knots per hour.} \end{aligned}$$

$$\text{Orbital velocity of surface particles} \left. \begin{array}{l} \\ \end{array} \right\} = 7\frac{1}{8} \times \frac{15}{\sqrt{400}} = 5\frac{1}{8} \text{ feet per second.}$$

It will be remarked that the orbital velocity of the particles is very small when compared with the speed of advance; and this is always the case. In formula V, if we substitute, as an average ratio for ocean waves of large size,

$$\text{Height} = \frac{1}{20} \times \text{length,}$$

the expression becomes—

$$\begin{aligned} \text{Orbital velocity of surface particles} &= 7\frac{1}{2} \times \frac{\frac{1}{20} \times \text{length}}{\sqrt{\text{length}}} \\ &= 0.355 \sqrt{\text{length}}. \end{aligned}$$

Comparing this with Formula II. for speed of advance, it will be seen that the latter will be between six and seven times the orbital velocity.

The periods of waves are most easily observed, and the following table will be useful as giving the lengths and speeds of trochoidal waves for which the periods are known:—

Period. Seconds.	Length. Feet.	Speed of Advance.	
		Feet per Second.	Knots per Hour.
1	5.12	5.12	3.03
2	20.49	10.24	6.07
3	46.11	15.37	9.1
4	81.97	20.49	12.14
5	128.08	25.62	15.17
6	184.44	30.74	18.21
7	251.04	35.86	21.24
8	327.89	40.99	24.28
9	414.99	46.11	27.31
10	512.33	51.23	30.35
11	619.92	56.36	33.38
12	737.76	61.48	36.42
13	865.84	66.6	39.45
14	1004.17	71.73	42.49
15	1152.74	76.85	45.52
16	1311.56	81.97	48.56

Systematic observations of ocean waves such as are now ordered to be made in the Royal Navy have not yet been sufficiently long continued to enable any test of the correctness of the trochoidal theory to be made from them. In the French navy, however, more has been done in this direction, and better information is accessible from the accounts published by various officers.* It now seems to be

* The observations of Lieutenant Paris, published in the *Revue maritime* (vol. xxxi.), and those of M. Duhil de Benazé, as well as the

analyses of numerous observations made in different ships, published by MM. Bertin and Antoine respectively, deserve special mention.

a well-established fact that the formula (given on page 167) connecting the periods and lengths of waves is a very good approximation to truth. Theory and the observations are not in complete accordance, as will be seen from the following table; but having regard to the difficulties of securing accurate measurements of lengths of waves, the results show a close agreement between the two. M. de Benazé and Lieutenant Paris have published the figures subjoined.

HALF-LENGTHS OF WAVES.

Observed.	Calculated.	Observed.	Calculated.
Metres.	Metres.	Metres.	Metres.
M. Duhil de Benazé. { 52·5	53·4	Lieutenant Paris. { 53	45
90	83·4	38	30
75	57·1	74	58
48	49·9	39	33
70	75	60	59
130	146	31	25
67·5	70·5		

A metre is 3·281 feet.

It will be noted that in all the observations of M. Paris the observed lengths exceed the calculated; whereas in those of M. de Benazé, in all except two cases, the observed lengths fall below those given by calculation. It would appear that usually the observed lengths are rather less than the theoretical lengths; and M. Antoine, after carefully analysing numerous observations made on board ships of the French navy, apparently reaches the same conclusion. The method of averages applied to such a case as this cannot be regarded as trustworthy, especially when it is known that in some instances errors, of considerable proportionate magnitude, exist in the individual observations; but in the main it is agreed that the expression, deduced from theory, for the length in terms of the period gives good results. When the observations now being made in all parts of the world by officers of the Royal Navy have been collected and analysed, we shall probably obtain confirmatory evidence on the point; and it is one to which we would particularly

direct the reader's attention, should he propose making observations of waves.

During a voyage of more than two years, Lieutenant Paris observed and recorded, several times each day, the state of the sea, and from these materials he subsequently prepared the following table, showing the periods of the waves most likely to be encountered in the following localities:—

Locality.	Mean Period.
	Seconds.
Atlantic (the Trades)	5·8
South Atlantic (region of the westerly winds)	9·5
Indian Ocean, South (region of the easterly winds)	7·6
Indian Ocean (trade winds)	7·6
China Seas	6·9
West Pacific	8·2

“This,” says M. Bertin,* “is no doubt a mere sketch, as regards the mean condition of the sea, to be completed and controlled by new researches; but it affords a measure of what can be done in a single voyage.” To all naval officers the naval architect may safely appeal to extend this branch of knowledge, affecting, as it does, very intimately the proper construction of ships; and even if the circumstances of their service should prevent such a comprehensive statement as the above being furnished by individual officers, the aggregate of the observations made by the ships of the Royal Navy ought far to exceed in importance and value the contributions derived from other sources. We need, above all, careful observations of wave periods; these should be accompanied by statements of the lengths; and, lastly, we need much more accurate and extensive observations of the heights and steepnesses of waves.

Theory, as was previously remarked, fixes the limiting ratio for height to length (the cycloidal form) in waves, but even on the steepest deep-water waves this is not

* In his essay on the “Experimental Study of Waves,” *Transactions of Institution of Naval Architects* for 1873.

approached. Observation of actual waves can therefore alone be trusted to satisfactorily settle this part of the subject. French investigators have endeavoured to formulate the results of such observations in expressions connecting the heights of waves with the force of the wind. Admiral Coupvent Desbois, in his memoir "On the Height of the Waves at the Surface of the Sea,"* laid down a provisional theory, based upon ten thousand actual observations, that the cube of the height of the waves is proportional to the square of the speed of the wind. M. Antoine, adopting this law, has made a very extensive analysis of the simultaneous observations of heights of waves and force of wind, recorded in returns from ships of the French navy, in order to see how far it may be trusted. He proposes the following formulæ,† which we give as only a rough and ready means of approximation, with the hope that they may hereafter be improved upon by English observers; the important problem to which they apply being at present unsolved, and the reasoning upon which the formulæ are based being open to serious, if not fatal, objections.

- Let V = speed of waves (in metres),
- v = " wind "
- 2L = length of waves "
- 2T = period " (in seconds),
- 2H = height " (in metres).

Then, assuming Admiral Coupvent Desbois' law to hold, the following are considered to be good approximations:—

$$2H = 0.75 \times v^{\frac{2}{3}} \dots (1)$$

$$2L = 30 v^{\frac{1}{2}} \dots (2)$$

$$2T = 4.4 v^{\frac{1}{4}} \dots (3)$$

$$V = 6.9 v^{\frac{1}{2}} \dots (4)$$

The "constants" in equations (1) and (4), M. Antoine derives from an analysis of numerous observations; those in equa-

* See the *Comptes rendus de les Lames de haute mer*, May 19
l'Académie des Sciences of 1866. 1876; also *Naval Science* for 1874.
 † See *Notes complémentaires sur*

tions (2) and (3) are derived from (4) by means of the theoretical formula given on page 167. Taking 130 observations made in vessels of the French navy, M. Antoine classifies them as follows:—

Speed of Wind.	Number of Observations per Series.	Waves.			
		Mean Lengths.		Mean Heights.	
		Observed.	Calculated by Approximate Formula.	Observed.	Calculated by Approximate Formula.
Metres per Second.		Metres.	Metres.	Metres.	Metres.
1.5	12	54.6	36	1.7	1
4	16	63.7	60	2.4	1.9
7	18	87.9	79.5	3.2	2.7
11	29	79.7	99.6	4	3.7
16	22	100	120	5.4	4.8
22	19	90	141	5.1	5.9
29	11	131	161	7.7	7.1
37	3	180	182	8.5	8.3

It will be observed that the calculated heights agree very closely with the observed heights; whereas there are very considerable differences between the calculated and the observed lengths. M. Antoine, having regard to possible errors in the various observations of winds and waves from which his constants in the formulæ are deduced, proposes to await further tests of his tentative formulæ before modifying them. He does not, however, appear to contemplate other than ordinary wave forms in his formulæ, nor to have tried his constants by the inverse process of taking ascertained dimensions for waves, and seeing what speed of wind would be required to create them, in accordance with his formulæ. Take, for instance, Scoresby's Atlantic waves 600 feet long by 40 feet high. We have from the preceding formulæ, for the velocity of the wind which would create such waves,

$$\text{By (1): } v = \left(\frac{40}{3.28} \times \frac{4}{3} \right)^{\frac{3}{2}} = 64 \text{ metres per second (about).}$$

$$\text{By (2): } v = \left(\frac{600}{3.28} \times \frac{1}{30} \right)^2 = 37 \text{ " " " "}$$

The velocity of 64 metres exceeds that of the wind in a hurricane; that of 37 metres is very high; whereas it is a matter of actual observation that waves of the dimensions named are created by winds having no such extraordinary speed. Nothing further need be added to show that formulæ which conduct to such results cannot be regarded as trustworthy. Their interest really centres in the attempt made thereby to express, in terms of the wind speed, wave features which must depend upon the force and speed of the wind; and it is for that reason they have been here given, not as representing accurately or even with general approximation the law of this dependence.

No theory has yet been accepted which represents the genesis of waves; the trochoidal theory merely deals with waves already created, and maintaining unaltered forms and velocities. There can, of course, be no question but that waves result from the action of the wind on the sea, and that there must be some connection between the character and the force of the wind and the dimensions and periods of the waves. But as yet we have not sufficient knowledge to determine either the mode of action of the wind or the law connecting its force with the dimensions of waves. Here again is a field where careful and extensive observations can alone be relied upon; pure theory would be useless. And here is, perhaps, the most difficult task which the naval officer, desirous of advancing our knowledge, can face; but, on the other hand, if it be successfully accomplished, the results will be interesting and valuable.

In the preceding pages it has been shown that, with care, the lengths, heights, and periods of waves may be determined very closely when the sea is not confused; and it is also possible, with care, to ascertain simultaneously the force or speed of the wind. But it is to be noted that the rapidity with which waves travel, and the fact that they maintain their lengths and speeds almost unchanged even when the force of the wind decreases and the wave height becomes

less, make it necessary to exercise great caution in associating any observed force of wind with the lengths and periods of waves observed simultaneously. The importance of this matter justifies further illustration.

If the wind is at first supposed to act on a smooth sea, and then to continue to blow with steady force and in one direction, it will create waves which finally will attain certain definite dimensions. The phases of change from the smooth sea to the fully formed waves cannot be distinctly traced. It is, however, probable that changes of level, elevations and depressions, resulting from the impact of the wind on the smooth surface of the sea, and the frictional resistance of the wind on the water are the chief causes of the growth of waves. An elevation and its corresponding depression once formed offer direct resistance to the action of the wind, and its unbalanced pressure producing motion in the heaped-up water would ultimately lead to the creation of larger and larger waves. This is probably the chief cause of wave growth, frictional resistance playing a very subordinate part as compared with it. So long as the speed of the wind relatively to that of the wave water is capable of accelerating its motion, so long may we expect the speed of the wave to increase; and with the speed the length, and also the height. Finally, the waves reach such a speed that the wind force produces no further acceleration, and only just maintains the form unchanged; then we have the fully grown waves. If the wind were now suddenly withdrawn, the waves would gradually decrease in magnitude and finally die out. This degradation results from the resistance due to the molecular forces in the wave—viscosity of the water, &c.—and when the waves are fully grown, the wind must at every instant balance the molecular forces. If the water were a perfect fluid (the particles moving freely past one another), and if there were no resistance to motion on the part of the air, the waves once formed would travel onwards without degradation. But in sea-water the degradation takes place at

a rate dependent upon the ratio of the resistance of the molecular forces to the "potential energy" of the wave.* At each instant the resistance abstracts a certain amount from the energy of the wave, and consequently the height decreases. The period and length of the wave might remain almost unchanged, and, it would seem from observation, really do so, while the height decreases; just as it has been shown that in a ship oscillating in still water the resistance developed gradually diminishes the range of oscillation without decreasing the period sensibly.

Between this condition of fully grown waves and the case of waves gradually dying out in a dead calm lies that which commonly occurs where the waves are gradually dying out, but the wind still has a certain force and speed. Then an observer, noting the dimensions of the waves and force of the wind simultaneously, might record lengths and periods corresponding, not to the observed force of wind, but to the force which existed when the waves were of their full size. On the other hand, there would, in all probability, be a correspondence between the observed force of wind and the observed heights, and an analysis of the recorded observations made by officers of the French navy confirms this view.† Nothing but the closest attention on the part of an observer can enable him to make his records a trustworthy basis for theory; for it is in his power alone, having regard to all the circumstances of the observations, to say whether, when observed, the waves are fully grown, and correspond to the observed force of wind, or whether they are in process of growth or of degradation. A series of observations might settle this matter, if made in a careful and intelligent manner; the growth or degradation being

* By "potential energy" of a wave is meant the work done in raising the centre of gravity of its mass a certain distance above the position which it would occupy in still water. See remarks as to this

rise on page 150.

† See remarks on M. Antoine's memoir, page 172. In his table the formulæ give far better approximations to heights than to lengths observed.

indicated by the alterations in heights of waves noted after certain intervals from the first observation.

Perhaps the most favourable time for observations to be begun would be that when on a nearly calm sea a storm breaks, forming waves of which the dimensions gradually increase; but the opportunities are not likely to be numerous where the waves so formed constitute an independent regular series. Usually the observer would probably find himself in face of a very confused sea, when the wave genesis is in its earlier stages; but if he could note the times occupied by waves in attaining their full growth under the action of winds of various speeds, he would do good service. Any pre-existing swell must be allowed for in making these observations; otherwise the assumption that the waves are formed from smooth water would be departed from.

In concluding these remarks on wave genesis, we cannot do better than quote from M. Bertin's essay:—"The study of the time necessary for each swell to retain its fixed and permanent condition under the action of the wind which produces it is very interesting. If the time be so long as in general to exceed that during which the wind can remain pretty nearly constant, both in intensity and direction, all interest in the connection between the wind and the swell would disappear. The length of waves and their inclination for a given length would be just as irregular as meteorological variations. If, on the contrary, the waves soon reach their regular condition—a fact which seems to be pretty well established, inasmuch as those seas which are exposed to the action of constant winds present no extraordinary agitation—one is necessarily driven to adopt the law that for each length of waves there is a certain height that is most commonly met with, and that cannot be exceeded."

The foregoing remarks on the persistence of wave periods and lengths after the force of wind and the original wave heights have decreased may account for a singular feature in the observations of M. Paris, who recorded the speeds of

winds accompanying speeds of waves, viz. that in many instances the speed of the waves exceeded that of the wind. Take, for example, the following records :—

Locality.	Mean Heights of Waves	Mean Speeds.*	
		Wind.	Wave.
	Metres.		
Atlantic (region of trade winds)	1·9	4·8	11·2
South Atlantic	4·3	13·5	14
Indian Ocean (South of)	5·3	17·4	15
Indian Ocean (region of trade winds)	2·8	6·5	12·6
Seas of China and Japan	3·2	14·6	11·4
West Pacific	3·1	8·5	12·4

* In metres per second ; a metre is 3·281 feet.

In the present state of our knowledge, we are not able to say that there is anything impossible in the observation of waves moving faster than the winds, which have a force corresponding to their full growth, although this condition would scarcely be anticipated. Remembering what was said above as to the difference between the rates of the actual orbital motions of particles in their circular orbits and the apparent speed of advance of the wave form, it will be clear that, even when the wave form advances faster than the wind travels, the wind may be moving much faster than the particles in the wave. Take, for example, the waves of the Southern Indian Ocean. M. Paris gives them a mean height of 5·3 metres, and a mean period of 7·6 seconds.

Diameter of orbits of surface particles . . = 5·3 metres.

Circumference of orbits of surface particles = 16·6 metres.

Orbital velocity of particles = $\frac{16·6}{7·6} = 2\frac{1}{4}$ metres per second.

Velocity of wind observed = 17·4 metres per second.

Whether the relative velocity of the wind and the wave form should be taken as the measure of the full effect of the wind, or whether the relative velocity of the wind and the particles of water in the wave does not also exercise considerable influence, must for the present be considered at

least a matter open to debate. In the maintenance of the wave speed as the wind speed slackens, we have a possible explanation of the apparent anomaly in the above table: and, further, it is difficult for an observer on board a ship in motion to measure the speed of the wind accurately. But actual observations, such as have been recommended in this chapter, will settle this and many other doubtful points.

Repeated references have been made to the difficulties attending the observation of wave dimensions in a *confused* seaway; and it appears desirable to illustrate the causes and character of the difficulty. A confused sea is caused by the superposition of two or more independent series of waves, each moving at its own speed, and all moving, possibly, in different directions. We will take the very simplest case of two series of unequal lengths and speeds, moving in the same direction. Fig. 65 shows a wave 400 feet long and 20 feet high, having a speed of about 45 feet per second; Fig. 66, a wave 200 feet long and 12 feet high, having a speed of about 32 feet per second. Fig. 67 shows the latter superposed upon the former, at the instant when the two crests coincide, and the combined wave has a maximum height of some 30 feet.* The long wave form gains about 13 feet per second on the shorter wave. In $2\frac{1}{2}$ seconds, the profile of the combined wave will have changed from the condition of Fig. 67 to that of Fig. 68; in less than 4 seconds the further change shown in Fig. 69 will have occurred; and in less than 8 seconds the condition shown in Fig. 70 will have been reached: a wave hollow appearing immediately over the crest of the 400-foot wave. In an actual seaway, the difficulties to be overcome in making observations of lengths and periods of waves, formed by the superposition of several distinct series, are far greater than

* The method of superposition will be understood from the diagrams; the larger wave being shown by a dotted line, and carrying the smaller one above it. This method

does not accurately represent the internal structure or onward movement of form in a confused sea, but will suffice for our present purpose.



in this simple illustration. The rapid and unceasing changes in the apparent forms, &c. of waves in a confused sea furnish an ample explanation of the differences sometimes noted in the simultaneous observations of waves by ships

FIG 65.



FIG 66.

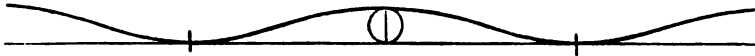


FIG 67.



FIG 68.

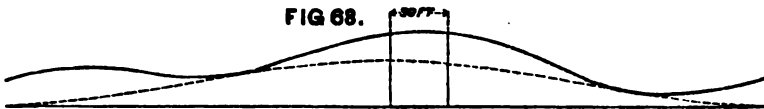


FIG 69.

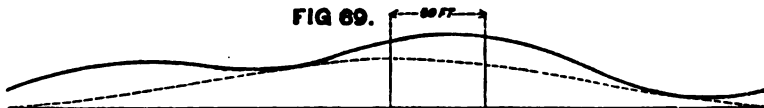
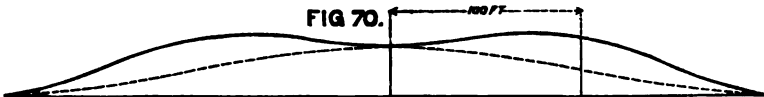


FIG 70.



sailing in company. In one instance, for example, one ship in a squadron reported the waves to be 450 feet long, whereas a second ship put the length at 150 feet; and at the first glance such a contrast seems absurd. But when, from the

diagrams (Figs. 67 and 70), it is seen that in some 8 seconds the apparent length between the highest crests of a combined wave may pass from 400 feet to 200 feet, and the maximum height from 30 feet to about 24 feet, one ceases to wonder at the seeming contradictions contained in records which may each have been substantially accurate.

During the last few years several attempts have been made to obtain motive power for propulsion or other purposes from the motions impressed upon a ship by the wave motion. Mr. Spencer Deverell, of Victoria, was the first to draw attention to the subject; and his brother conducted a series of observations in 1873 during a voyage from Melbourne to London, for the purpose of proving that during an ocean voyage a ship will be continually oscillating—rolling, pitching, and heaving—even when there is a dead calm. Limits of space prevent any extracts being given from the interesting records of these observations, which will well repay perusal; nor can any account be given of the apparatus proposed for the purpose of obtaining motive power from the wave motion.* The principle of all the proposals may be simply explained. In a seaway the heaving and other motions impressed upon a ship cause variations in her virtual weight (as explained at page 155). If a weight inboard is suspended by a spring-balance, the latter will indicate less than the true weight on the wave crest, and more than the true weight in the wave hollow. The *extensions of the spring* will vary according to the virtual weight, being greatest at the wave hollow, and least at the crest. By some appropriate mechanism these varying extensions of the spring are made to produce rotary or other motions. Numerous experiments have been made with models, but hitherto, we believe, no practical use has been made of the principle.

* See papers on "Ocean Wave Power and its Utilisation," in the *Transactions* of the Royal Society of Victoria for 1873; and "The Continuous Oscillation of a Ship during an Ocean Voyage," in the

Transactions of the Institution of Naval Architects for 1874, by Mr. Spencer Deverell; also a paper by Mr. Tower in the *Transactions* of the Institution of Naval Architects for 1875.

CHAPTER VI.

THE OSCILLATIONS OF SHIPS AMONG WAVES.

IN the two preceding chapters we have discussed the condition of a ship oscillating in still water, and the phenomena of wave motion in the deep sea, subjects which have an interest in themselves, but derive their greatest importance from their connection with the subject now claiming attention. The motions of a ship in a seaway are influenced by her stability, her inertia, by the variations in direction and magnitude of the fluid pressure incidental to wave motion and by the fluid resistance; so that, without clear and correct conceptions of each of these features in the problem, it would be impossible to deal with their combined effect.

All oscillations of a ship in a seaway, like those in still water, may be considered as resolvable into two principal sets: the first, the transverse oscillations of rolling; the second, the longitudinal oscillations of pitching and 'scending. It is therefore only necessary to consider these two directions; and of them, the transverse, having by far the most important bearing upon the safety and good behaviour of ships, will receive the greatest attention. Pitching and 'scending may become violent and objectionable in some ships, but this is not commonly the case, nor is it so difficult of correction as heavy rolling. Only a brief discussion of these longitudinal oscillations will therefore be necessary; and it will follow the remarks on rolling.

Very various causes have been assigned for the rolling motion of a ship at sea. Some of the earlier writers, im-

pressed by the great speed of advance of waves, attributed rolling to the shocks of waves against the sides of ships. Others considered motion as originated by the slope of the wave surface; observing that, if a ship remained upright on the wave slope, her displacement would change its form from that in still water, the centre of buoyancy moving out from below the centre of gravity towards the wave crest, and the moment of stability thus produced tending to make the vessel heel away from the wave crest. But there were obvious objections to both these theories; it is a matter of common experience that vessels often roll very heavily in a long smooth swell, where the slope is so small that the departure from the horizontal is scarcely perceptible, and where no sensible shock is delivered against the sides of the ships. The best of the earlier theories, put forward by Daniel Bernoulli, about a century ago, departed from the preceding theories, and was content to speak of the oscillations of a ship as comparable to those of a pendulum, subjected to the action of "impulses" from the waves, no analysis being attempted of the character or causes of these impulses. Some of the conclusions which Bernoulli reached even now command respect; but he, in common with his contemporaries, failed to realise or to express the fundamental condition wherein wave water differs from still water, viz. that the direction and intensity of the fluid pressure are continually varying instead of being constant, as in still water. For nearly a century the subject remained very nearly in the condition in which Bernoulli, Euler, and other writers of that period, had left it; and it was reserved for an Englishman, Mr. W. Froude, to have the honour of introducing the modern theory of rolling. This theory rests upon the fundamental doctrine, explained in the previous chapter, that in wave water the direction of the pressure at any point is a normal to the trochoidal surface of equal pressure passing through that point; and in that particular the modern theory differs from all that preceded it. It is not put forward as a perfect theory, fully expressing all the

conditions of the problem; but it far more completely represents those conditions than any theory which preceded it, and has exercised a great and beneficial effect upon ship designs during the fifteen years it has been before the world. Moreover, in its main features, it has secured the adhesion of the greatest authorities on the science of naval architecture, both English and foreign, some of whom have very considerably helped its extension. An attempt to describe in popular language the main features of the theory cannot, therefore, be devoid of interest, even though the avoidance of mathematical language may render the description which follows incomplete.

At the outset it may be well to state that the modern theory of rolling finds the governing conditions of the behaviour of a ship among waves to be twofold:—

(1) The ratio which the period of the still-water oscillations of the ship (or “natural period”) bears to the period of the waves amongst which she is rolling.

(2) The magnitude of the effect of fluid resistance.

Both the natural period and the means of estimating the magnitude of the fluid resistance for any ship may be obtained from experiments made in still water, as previously explained.

It will be convenient to deal separately with these conditions, first illustrating the causes which make the ratio of the periods so important, and in doing so leaving resistance out of account; afterwards illustrating the effect of resistance in limiting the range of oscillation. In practice the two conditions, of course, act concurrently; but the hypothetical separation here made will probably enable each to be better understood.

Reverting to the case illustrated by Fig. 61, page 151, where a small raft floats upon the inclined surface (AB) of the water in a vessel which is moving horizontally, it will be noticed that the raft is acted upon by the following fluid pressures:— P , acting downwards on the upper side, an equal pressure, P , acting upwards on the lower side, and the buoyancy b acting normally to the surface AB through the centre

of buoyancy of the raft. If w be the weight of the raft (acting vertically downwards through the centre of gravity) when the vessel containing the water is in motion, this weight w must be combined with the horizontal accelerating force due to the motion, in the manner explained in the previous chapter when dealing with the slope at which the water surface will stand.* Using the same notation as before, we have—

$$\left. \begin{array}{l} \text{Resultant of weight and horizontal} \\ \text{accelerating force} \end{array} \right\} = w \sec a,$$

This resultant will act perpendicularly to the inclined water surface, just as the buoyancy b does; and for equilibrium we must have—

$$b = w \sec a,$$

and the line of action of b must pass through the centre of gravity of the raft. Hence it follows that the normal to the free water surface indicates the direction towards which the raft will tend to return if her mast is inclined from it; just as in still water the upright is her position of equilibrium. The normal to the water surface may therefore be termed the “virtual upright” for the raft when it and the water are subjected to horizontal acceleration; since the normal fixes the position of equilibrium.

Next suppose this very small raft to float on the surface of a wave, as in Fig. 62, page 153. Here reasoning similar to the foregoing applies if the raft be considered so small in relation to the wave that it may be treated as if it replaced a particle, and moved just as the particle would have done. In the preceding chapter it has been shown that at any point in a trochoidal wave the normal represents the direction of fluid pressure at that point, and it has also been stated that this direction changes from point to point along the wave surface, the variations in inclination resembling the

* See page 152.

oscillation of a pendulum having a period for a single swing equal to half the wave period. The cases of Figs. 61 and 62, therefore, differ in this: in the former, where the water surface has a constant inclination, the "virtual upright" also has a constant direction; whereas on the wave the "virtual upright," or position of equilibrium, in which the masts of the raft will lie, varies in direction from instant to instant, the variations being dependent upon the wave slope and wave period. On the wave the raft is also subjected to vertical as well as horizontal accelerations, affecting both the value of the fluid pressure upon its bottom and its own apparent weight, but affecting both equally, and therefore not changing the displacement of the raft from that in still water. The law of this variation in the pressure and apparent weight has been given in the preceding chapter, and illustrated by Fig. 60, page 151; but for our present purpose the variation in the direction of the pressure is of greater importance.

A ship differs from this hypothetical raft, having lateral and vertical extension in the wave, as shown by ABC in Fig. 62. Even though she may be small when compared with the wave, it is obvious that she cannot be treated as a single particle replacing a particle in the wave. At any moment she displaces a number of particles which, were she absent, would be moving in orbits of different radii, and at different speeds. Her presence must therefore introduce a disturbance of the internal motions in the wave, and this disturbance must in some manner react upon the ship and somewhat influence her behaviour. At present our knowledge of the conditions governing the internal molecular forces in the waves of the sea is not sufficient to enable exact mathematical treatment to be applied in estimating the effect of this disturbance, and determining at each instant the position of the "virtual upright" for the ship. If the positions of the virtual upright were known, each of them would be a normal to a surface termed the "effective wave slope." Conversely, the effective wave slope may be defined

as the surface of which the profile has a length equal to that of the wave, and the normal to which at any point represents the instantaneous position of equilibrium for the masts of the ship.

It has sometimes been assumed that the effective slope will nearly coincide with the trochoidal subsurface passing through the centre of buoyancy of the ship. In Fig. 62, let B represent the centre of buoyancy of the ship shown in section by ACD; then TT_1 , the subsurface of equal pressure passing through B, would be termed the effective wave slope, and the normal to it, NN_1 , drawn through B, would be taken as determining the instantaneous position of equilibrium for the ship. In the diagram the ship is shown purposely with her middle line (GM) not coincident with the normal NBN_1 ; M is the point of intersection of these lines, and the angle BMG measures the inclination of the ship from the position of equilibrium. Through the centre of gravity G, GZ is drawn perpendicularly to NN_1 ; then instantaneously the effort of stability, or righting moment, with which the ship tends to move towards the position NN_1 , is measured by the expression—

$$\text{Righting moment} = \text{apparent weight} \times GZ.$$

In estimating the apparent weight of the ship, which is practically equal to, and has a line of action parallel to, the fluid pressure acting along NN_1 , it is of course necessary to take account of the radii of the particles situated in the subsurface TT_1 . Very often the actual weight may be substituted for the apparent weight without any great error; but this is a matter easily investigated, in accordance with the principles previously explained.

This method of approximating to the effective slope, although widely adopted, is not universally accepted, nor does it profess to be more than an average or approximation. The form of the immersed part of the ship, her lateral extension along the wave, and other circumstances are known to affect the position of the effective slope, making

it in some cases lie much nearer the upper surface than TT_1 would be situated. In most cases, however, the effective slope is less steep than the upper surface; a fact which is confirmed by the careful and extensive observations made by Mr. Froude on board the *Devastation*. In practice, therefore, it is an error on the side of safety to assume, as is not unfrequently done, that the variations in inclination and magnitude of the fluid pressure and the apparent weight of the ship may be determined from the upper surface of the wave. This was the plan adopted by Mr. Froude in his earliest investigations, as well as that followed by the Admiralty Committee on Designs for Ships of War in their estimate of the probable limits of rolling of the *Devastation* class. It will be seen that this substitution of the upper surface for the less steep effective surface in no way affects the period occupied by the wave normal in performing the set of motions from upright at the hollow onward to upright at the crest of a wave, since all subsurface trochoids in a wave have the same period as the upper surface. The difference is solely one of the maximum inclination to the vertical reached by the wave normal, and taking the upper surface somewhat increases this beyond the true maximum.

Suppose a ship lying broadside-on to the waves to be upright and at rest when the first wave hollow reaches her; at that instant the normal to the surface coincides with the vertical, and there is no tendency to disturb the ship. But a moment later, as the wave form passes on and brings the slope under the ship, the virtual upright towards which she tends to move becomes inclined to the vertical. This inclination at once develops a righting moment tending to bring the masts of the ship into coincidence with the instantaneous position of the normal to the wave. Hence rolling motion begins, and the ship moves initially at a rate dependent upon her still-water period of oscillation. Simultaneously with her motion, the wave normal is shifting its direction at every instant, becoming more and more inclined to the vertical, until near the mid-height of the wave it

reaches its maximum inclination, after which it gradually returns towards the upright; the rate of this motion is dependent upon the period of the wave. Whether the vessel will move quickly enough to overtake the normal or not depends upon the ratio of her still-water period to the interval occupied by the normal in reaching its maximum inclination and returning to the upright again, which it accomplishes at the wave crest; this interval equals *one-half* the period of the wave. Hence it appears that the ratio of the period of the ship (for a single roll) to the half-period of the wave must influence her rolling very considerably, even during the passage of a single wave, and still more is this true when a long series of waves move past the ship, as will be shown hereafter.* It will also be obvious that the real cause of the rolling of ships amongst waves is to be found in the constant changes in the direction of the fluid pressure accompanying wave motion.

As simple illustrations of the foregoing remarks, two extreme cases may be taken. The first is that of a little raft, like that in Fig. 62, having a natural period indefinitely small as compared with the half-period of the wave. Her motions will consequently be so quick as compared with those of the wave normal that she will be able continuously to keep her mast almost coincident with the normal and her deck parallel to the wave slope. Being upright at the wave hollow, she will have attained one extreme of roll about the mid-height of the wave, and be again upright at the crest; the period of this single roll will be half the wave period. And as successive waves in the series pass under the raft, she will acquire no greater motion, but

* It has already been explained that we follow the Admiralty method in terming a single roll "an oscillation," and the time occupied in its performance the "period of oscillation." Mathematicians commonly apply the term

oscillation to a double roll, and the term period to the time occupied in performing the double roll. We again refer to the matter, as in many published papers the mathematical terms are employed.

continue oscillating through a fixed arc and with unaltered period. The arc of oscillation will be double the maximum angle of wave slope.

No ship actually fulfils these conditions, but some classes of broad flat vessels having very quick periods approach them closely, and, when among long waves, acquire a fixed range of oscillation, keeping their decks approximately parallel to the wave slope, and therefore shipping but little water. As examples, the deep-sea fishing-boats used off the Dutch coast at Scheveningen may be named; and amongst war-ships, the American monitor type. It is reported of the *Miantonomoh*, which crossed the Atlantic about ten years ago, with a height of upper deck above water of only 3 feet, that she rolled but moderately in heavy weather, and shipped very little water on her low deck, even when broadside-on to large waves, the water which did come on the deck on the weather side usually passing off again on the same side as that it broke over.* This is very good evidence that the motions of the monitor were so quick relatively to the wave motion that her deck was kept approximately parallel to the surface; otherwise, with the low freeboard, much greater quantities of water would have been shipped. Before this experience was obtained, theoretical investigations had led to the conclusion that vessels of small periods would probably tend to fall into oscillations of definite range, keeping pace with the wave motion; so that observation has here confirmed theory. Obviously such a vessel would not be a steady gun platform, as the range of her oscillation might be considerable, being governed by the wave slope. For instance, if the *Miantonomoh* were placed broadside-on to Atlantic storm waves such as Dr. Scoresby observed, say, 600 feet long and 30 feet high, the maximum slope of the wave would be about 9

* See Captain Bythesea's evidence before the Committee on Designs in 1871. *Parliamentary Papers*. The Russian circular ships have even

quicker periods than the monitors, and their great lateral extension on the wave further tends to diminish their oscillations.

degrees, and its period about 11 seconds. Once in every $5\frac{1}{2}$ seconds (the half wave period), therefore, if the ship kept pace with the wave, she would really swing through a total arc of 18 degrees—9 degrees on either side of the vertical, although to an observer on board, owing to causes explained in the preceding chapter, she might seem to continue nearly upright. The wave period is about twice the natural period for a double roll of the monitor.* In other words, while the wave normal or virtual upright in $5\frac{1}{2}$ seconds completes a single set of motions between the hollow and crest, the monitor can move twice as quickly, and may therefore keep her deck nearly parallel to the surface.

The second simple illustration is that of a small vessel, of very long period as compared with the wave period. Such a vessel would secure slow motion by having very little initial stability, or very great moment of inertia, or by a combination of both these features. It is not impracticable to actually construct a vessel having a very long period as compared with even very long waves; although other considerations, previously mentioned, limit the application of this power. If such a vessel were upright and at rest in the wave hollow, she would be subjected to rolling tendencies similar to those of the raft, owing to the successive inclinations of the wave normal—her instantaneous virtual upright. But her long period would make her motion so slow as compared with that of the wave normal that, instead of keeping pace with the latter, the ship would be left far behind. In fact, the half wave period during which the normal completes an oscillation would be so short relatively to the period of the ship that, before she could have moved far, the wave normal would have passed through the maximum inclination it attains near the mid-height of the wave, and rather more than halfway between hollow and crest. From that point

* See the table of periods on page 114.

onwards to the crest it would be moving back towards the upright; and the effort of the ship to move towards it, and further away from the upright, would in consequence be diminished continuously. At the crest the normal is upright, and the vessel but little inclined—inclined, it will be observed, in such a sense that the variations in direction of the normal, on the second or back slope of the wave, will tend to restore her to the upright. Hence it follows that the passage of a wave under such a ship disturbs her but little, her deck remains nearly horizontal, and she is a much steadier gun platform than the monitor or raft-like vessel.

Observation and experience with actual ships confirm the general correctness of these conclusions, although no ship has the indefinitely long period attributed to the hypothetical vessel. Her Majesty's ship *Inconstant* has an exceptionally long period, occupying about 8 seconds for a single roll, a period about twice as long as the half-period of waves commonly met in an Atlantic storm, with lengths of 250 or 300 feet. This vessel has also an exceptional reputation for steadiness; it will suffice to quote one report only made upon her behaviour. After witnessing her performances with the Channel Squadron in 1869,* Mr. Barnaby (now Director of Naval Construction) said, "The Atlantic waves, as they rolled across her beam, lifted her up vertically, and she remained steadily upright, when some of the other ships in the squadron were showing the whole of their decks to the ships in the other line." Nor is this peculiar to the *Inconstant*; other ships of recent design, including many ironclads having long natural periods, have acquired similar reputations for steadiness. For example, in a published report on the trials of the squadron of 1871, it was said of the *Monarch*, "The seas appeared to roll underneath her bottom, lifting her and lowering her again, with the rise and fall of the water, in continuous vertical motion."

* See Report of Committee on Designs.

Many other cases in point might be cited, but this is unnecessary.

Between the extreme cases of exceptionally quick-moving ships and ships of very long periods lie the common cases where the natural periods of the ships approximate more or less closely to equality with the half-periods of the storm waves ordinarily encountered. Theory, taking account of all cases, does not define the ratio of the periods in the general investigation, but expresses the solution in a form admitting of the application of any chosen ratio to the final result. Following a similar course, and having cleared the way by the foregoing illustrations, we shall now give a general sketch of the method introduced by Mr. Froude.

The following assumptions are made in order to bring the problem of the motion of a ship in a seaway within the scope of mathematical treatment:—

(1) The ship is regarded as lying broadside-on to the waves, and without any motion of progression in the direction of the wave advance: in other words, she is supposed to be rolling passively in the trough of the sea.

(2) The waves to which she is exposed are supposed to form a regular independent series, successive waves having the same dimensions and periods.

(3) The waves are supposed to be large as compared with the ship, and she is assumed to accompany their motion; so that at any instant she would rest in equilibrium with her masts coincident with the corresponding normal to the "effective slope," which is commonly assumed to coincide with the upper surface of the wave.

(4) The variations of the apparent weight are supposed to be so small, when compared with the actual weight, that they may be safely neglected, except in very special cases.

(5) The effects of fluid resistance are considered separately, and in the mathematical investigation the motion is supposed to be unresisted.

It will at once be remarked that ships commonly encounter a confused sea, and not a single regular series of waves; but

the varying conditions of such a sea, formed by the superposition of independent series as explained in the preceding chapter, cannot well be brought within the scope of exact calculation. Moreover, it appears from extensive observations of the behaviour of ships that the irregularities of a confused sea frequently tend to check the accumulation of rolling motion; the heaviest rolling being produced by a regular series of waves. Exceptions to this rule probably occur, but as the ship is placed in the worst position—passively rolling in the trough of the sea—it may be fairly assumed that suppositions (1) and (2) may be admitted. To the next it may be objected with justice that ships are not always very small, as compared with the waves amongst which they roll; on the other hand, it is well known that the heaviest rolling is produced by the largest waves, while the supposition of relative smallness is favoured by the smallest dimension of the ship—her beam—being presented to the length of the wave. Variations in apparent weight are also occasionally of considerable importance; still, in tracing the general character of the motion of a ship, no great error arises from neglecting them. The effects of fluid resistance are most important, as will be seen hereafter, but the attempt to introduce those effects into the general mathematical equations only gives them a form that cannot at present be dealt with; and the effect of resistance can be allowed for separately. Perhaps at some future time better and more complete assumptions may be made upon which to base a more perfect theory; but those stated above are, on the whole, the best that can now be made. They are confessedly open to some objections; but they have one great recommendation in their favour, viz. that the results of experience and observation confirm the general accuracy of the deductions drawn from the theory based upon them.

The necessity for avoiding high mathematical reasoning in the present work makes it impossible to follow out the construction and solution of the equations of motion.

The following are the principal steps. Some fixed epoch is chosen wherefrom to reckon the time at which the ship occupies a certain position on the wave slope, and has an unknown inclination (θ) to the vertical. The inclination (θ_1) to the vertical of the wave normal for that position can then be expressed in terms of the steepness of the wave and the wave period; both ascertainable quantities. Next the angle ($\theta - \theta_1$) between this normal and the masts can be deduced from the preceding expressions; and the righting moment corresponding to that angle can be estimated. This moment constitutes the active agency controlling the motion of the ship at that instant, and it must be balanced by the moment of the accelerating forces, which can be expressed in terms of the inertia of the ship and the angular acceleration.* Finally, an equation is obtained involving the following terms:—The angular acceleration at that instant; the inclination of the masts of the ship to the vertical at that instant; and the effort of stability at that instant. The solution of this equation furnishes an expression for the unknown angle of inclination (θ) of the ship to the vertical at any instant, in terms of her own natural period, the wave period, the ratio of the height to the length of the wave, and certain other known quantities. Assuming certain ratios of the period of the ship to the wave period, it is possible from the solution to deduce their comparative effect upon the rolling of the ship; or, assuming certain values for the steepness of the waves, to deduce the consequent rolling as time elapses, and a continuous series of waves passes the ship. In fact, the general solution gives the means of tracing out the unresisted rolling of a ship for an unlimited time, under chosen conditions of wave form and period. A few of the more important cases may now be briefly mentioned, it being understood that the theory deals with unresisted rolling only.

One critical case is that for which the natural period of the ship for a single roll equals the half-period of the wave.

* See the explanations of these terms given at page 107.

This had been foreseen by several of the earlier writers, including Daniel Bernoulli, apart from mathematical investigation, from the analogy between the motions of a ship and a pendulum. It is a matter of common experience that, if a pendulum receive successive impulses, keeping time with (or "synchronising" with) its period, even if these impulses have individually a very small effect, they will eventually impress a very considerable oscillation upon the pendulum. A common swing receiving a push at the end of each oscillation is a case in point. When a similar synchronism occurs between the wave impulse and the period of the ship, the passage of each wave tends to add to the range of her oscillation, and were it not for the deterrent action of the fluid resistance, she would finally capsize. Such, in general terms, was the opinion of the earlier writers, which recent and more exact investigations have fully confirmed. Apart from the action of resistance, Mr. Froude shows that the passage of a single wave would increase the range of oscillation of the ship by an angle equal to about three times the maximum slope of the wave. For instance, in an Atlantic storm wave series, each wave being 250 feet long and 13 feet high, and having a maximum slope of some 9 degrees, the passage of each wave would, if there were no resistance, add no less than 27 degrees to the oscillation of the ship; so that a very few waves passing her would overturn her. Here, however, the fluid resistance comes in, and puts a practical limit to the range of oscillation in a manner that will be explained hereafter.

It may be well to examine a little more closely into the character of the wave impulse which creates accumulated rolling in this case. Suppose a vessel to be broadside-on in the wave hollow when the extremity of her roll is reached, say to starboard, the waves advancing from starboard to port. Then the natural tendency of the ship, apart from any wave impulse, will be to return to the upright in an interval equal to one-half her period, which by hypothesis will be equal to the time occupied by the passage of one-fourth the wave

length. In other words, the ship would be upright midway between hollow and crest of the wave near which its maximum slope occurs. Now, at each instant of this return roll towards the upright the inclination of the wave normal, fixing the direction of the resultant fluid pressure, is such as to make the angle of inclination of the masts to it greater than their inclination to the true vertical; that is to say, the inclination of the wave normal at each instant virtually causes an increase of the righting moment. Consequently, when the vessel reaches the upright position at the mid-height of the wave, she has by the action of the wave acquired a greater velocity than she would have had if oscillating from the same initial inclination in still water. She therefore tends to reach a *greater inclination* to port than that from which she started to starboard; and this tendency is increased by the variation in direction of the wave normal between the mid-height and the crest—that part of the wave which is passing the ship during the period occupied by the second half of her roll. On reference to Fig. 62—where the directions of the wave normal are indicated by the masts of the rafts—it will be seen that, when the ship during the second half of the roll inclines her masts away from the wave crest, the angle between them and the wave normal is constantly less than the angle they make with the vertical. The effect of this is to make the righting moment less at every instant during the second half of the roll on the wave than it would have been in still water. For unresisted rolling, it is the work done in overcoming the resistance of the righting couple which extinguishes the motion away from the vertical. On the wave, therefore, the vessel will go further to the other side of the vertical from that on which she starts than she would do in still water, for two reasons: (1) she will acquire a greater velocity before she reaches the upright; (2) she will experience a less resistance from the righting couple after passing the upright. From the above statements, it will be evident that there must be a direct con-

nection between the maximum slope of the wave and the successive increments of her oscillations.

More or less close approximation to this critical condition will give rise to more or less heavy rolling; but it is a noteworthy fact that, even where the natural period of the ship for small oscillations equals the half-period of the wave, and may thus induce heavy rolling, the synchronism will almost always be disturbed as the magnitude of the oscillations increases; the period of the ship will be somewhat lengthened, and thus the further increments of oscillation may be made to fall within certain limits, lying within the range of stability of the ship. It will be understood that this departure from isochronism in no way invalidates what was said in Chapter IV. as to the isochronism of ships of ordinary form when oscillating 10 or 15 degrees on either side of the vertical. The character of the change can best be illustrated by reference to a common simple pendulum. Such a pendulum swinging through very small angles on either side of the vertical has, say, a period of one second; if it swings through larger angles, its period becomes somewhat lengthened, and the following table expresses the change:—*

Angles of Swing.	Period.
	Seconds.
Very small	1
30°	1·017
60°	1·073
90°	1·183
120°	1·373
150°	1·762

For ships the angles of swing are never so great as to make the increase of period great proportionally, but yet, as above remarked, the increase may be sufficient to add sensibly to the safety of a ship exposed to the action of waves having a period double of her own period for small oscillations;

* See Report of Committee on discussion of the probable safety Designs, where Professor Rankine in a seaway of the *Devastation* applied similar reasoning to the class.

although it is by the action of resistance that the overturning of a ship so circumstanced is chiefly prevented.

No feature in the behaviour of ships is better established than that heavy rolling results from equality or approximate equality of the period of a ship and the half-period of waves, even when the waves are very long in proportion to their height. Many facts might be cited in support of this statement, but a few must suffice. Admiral Sir Cooper Key observed that the vessels of the *Prince Consort* class were made to roll very heavily by an almost imperceptible swell, the period of which was just double that of the ships. Captain R. Vesey Hamilton informed the Author that, on one occasion, the *Achilles*, a vessel having a great reputation for steadiness, rolled more heavily off Portland in an almost dead calm than she did off the coast of Ireland in very heavy weather. Mr. Froude reports a very similar circumstance as having occurred during trials with the *Active*. And, lastly, during the cruise of the Combined Squadrons in 1871, when the *Monarch* far surpassed most of the ships present in steadiness in heavy weather, there was one occasion when, doubtless through the action of approximately synchronising periods, she rolled more heavily in a long swell than did the notoriously heavy rollers of the *Prince Consort* class.

It may be interesting to note that the period of the *Prince Consort* class, from 5 to $5\frac{1}{2}$ seconds, would just synchronise with the half-period of waves from 500 to 600 feet long. It has been stated in the preceding chapter that these are almost identically the dimensions which careful and extensive observations have led us to accept as belonging to the very large Atlantic storm waves Dr. Scoresby and others have encountered. Hence it is easy to explain the relative bad behaviour of these converted ironclads with their quick motion and short period. As an example, and by no means an exceptional one, of the contrast between these ships and vessels of more recent design, the following table of observations made during the cruise of 1871 will be of interest.

The weather was reported to be exceptionally heavy, but unfortunately no particulars were noted of the dimensions and periods of the waves.

Ships.	Approximate Natural Periods.	Arcs of Oscillation.
	Seconds.	Degrees.
<i>Lord Warden</i>	} 5 to 5½	62
<i>Caledonia</i>		57
<i>Prince Consort</i>		46
<i>Defence</i>		49
<i>Minotaur</i>	} 7 to 7½	35
<i>Northumberland</i>		38
<i>Hercules</i>	8	25

In concluding these remarks on the effects of approximate synchronism of periods, it may be well to draw attention to the fact that the truth of theoretical deductions may be best tested by changing the course of a ship relatively to the advance of the waves; this has been done most satisfactorily during the trials of the *Devastation*, the ship remaining in the same condition, and the waves, of course, remaining unchanged, while the *apparent period* of the waves was altered by change of course and speed.*

Lying passively broadside-on to waves having a period of about 11 seconds, the *Devastation* was observed to roll through the maximum angles of 6½ degrees to windward, and 7½ degrees to leeward, making the total arc 14 degrees. She was then put under weigh, and steamed away from the waves at a speed of 7½ knots, having the wind and sea on her quarter, when her maximum roll to windward became 13 degrees, and to leeward 14½ degrees, making the total arc 27½ degrees. The difference between the two cases is easily explained, in view of the foregoing considerations. When rolling passively in the trough of the sea, the apparent period of the waves was their real period; and this was less

* For an explanation of the term "apparent period," see page 159 of preceding chapter.

than the double period for the *Devastation* (13½ seconds). When she steamed away obliquely to the line of advance of the waves, their apparent period became increased, and the diagrams of the ship's performance then taken showed that the speed and course of the ship had the effect of making the apparent period of the waves just equal to the period of a double roll for the *Devastation*—in fact, established that synchronism of ship and wave which is most conducive to the accumulation of motion.

This case also furnishes an example of what to every sailor is a truism, viz. that the behaviour of a ship is greatly influenced by her course and speed relatively to the waves. Theory, as we have shown, takes account of the case which is probably the worst for most vessels—the condition of a ship which has become unmanageable, and rolls passively in the trough of the sea. But so long as a ship is manageable, the officer in command can largely influence her behaviour by the selection of the course and speed, which make the ratio of the periods of ship and wave most conducive to good performance. In the case of the *Devastation* just cited, had she steamed obliquely, as before, but head to sea, the apparent period of the waves would have been decreased, and the rolling would probably have been less than it was in either case recorded. Of course, synchronism in some cases may be produced by steaming towards, instead of from, the waves. For instance, if a ship having a period of 4 to 5 seconds had been amongst the waves which the *Devastation* encountered, when broadside-on, her period would have been less than half that of the waves: but if she had steamed obliquely towards the waves, their apparent period might have been lessened, and made about 8 to 10 seconds. However obtained, such synchronism must lead to the heaviest rolling the vessel is likely to perform: and the steeper the waves the heavier is the rolling likely to be.

A second important deduction from the general theory is found in the so-called "permanent" oscillations of ships. If a vessel has been for a long while exposed to the

action of a single series of waves, she is likely to have acquired a certain maximum range of oscillation, and to perform her oscillations, not in her own natural period, but in the possibly different wave period. This case differs from the preceding one in that the period of the ship for still-water oscillations does not agree with the half-period of the wave; but, notwithstanding, the oscillations among waves keep pace with the wave, their period being "forced" into coincidence with the half-period of the wave. At the wave hollow and crest a ship so circumstanced may be supposed to be upright; she will reach her maximum inclination to the vertical when the maximum slope of the wave is passing under her (about the mid-height of the wave); and the passage of a long series of waves will not increase the range of her oscillations which are "permanent" in both range and period—hence their name. The maximum inclination then attained depends, according to theory, upon two conditions: (1) the maximum slope of the wave; (2) the ratio of the natural period of oscillation of the ship to one-half the wave period.

Let a = maximum angle made with the horizon by the wave profile;

θ = maximum angle made with the vertical by the masts of the ship;

T = natural period of still-water oscillations of the ship;

$2T_1$ = period of wave.

If fluid resistance is neglected, and the conditions above stated are fulfilled, mathematical investigation for this extreme case leads to the following equation:—

$$\theta = a \cdot \frac{1}{1 - \frac{T^2}{T_1^2}} = \frac{a \times T_1^2}{T_1^2 - T^2}.$$

Three cases may be taken in order to illustrate the application of this equation.

I. Suppose $T = T_1$, then θ becomes *infinity*; that is to say, we have once more the critical case of synchronism previously discussed, respecting which nothing need be added.

II. Suppose T less than T_1 , so that $\frac{T^2}{T_1^2}$ is a proper fraction less than unity: then θ and α always have the same sign, which indicates that the masts of the ship lean away from the wave crest, at all positions, except when the vessel is upright at hollow and crest. The closer the approach to equality between T_1 and T , the greater the value of θ ; which is equivalent to an enforcement of the statement previously made, that approximate synchronism of periods leads to heavy rolling. The smaller T becomes relatively to T_1 , the smaller does θ become; its maximum value being α when T is indefinitely small relatively to T_1 . This is the case of the raft in Fig. 62, page 153, which keeps its masts parallel to the wave normal.

III. Suppose T greater than T_1 : then θ and α are always of opposite signs, and, except at hollow and crest, the masts of the ship always lean towards the wave crest. The nearer to unity is the ratio of T to T_1 , the greater is θ ; illustrating as before the accumulation of motion when there is approximate synchronism. The greater T becomes relatively to T_1 , the less does θ become; in other words, we have the case of such a ship as the *Inconstant*, which keeps virtually upright as the wave passes.

As an example of the use of the formula, take the following figures drawn from the report on the behaviour of the *Derivation* during her passage to the Mediterranean:—

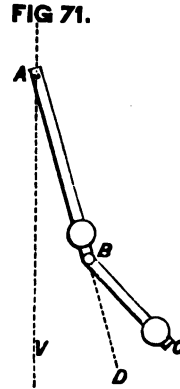
$$\begin{array}{l} \alpha = \text{maximum wave slope} \dots\dots = 1\frac{1}{2} \text{ degrees;} \\ \left. \begin{array}{l} T = \text{natural period of ship for single} \\ \text{roll} \dots\dots\dots \end{array} \right\} = 6\cdot8 \text{ seconds;} \\ T_1 = \text{half (apparent) wave period} \dots = 6 \quad \text{,} \end{array}$$

If the conditions of permanent rolling had been fulfilled, the formula would give—

$$\begin{aligned} \left. \begin{array}{l} \text{Maximum inclination of ship, sup-} \\ \text{posing motion unresisted} \dots\dots \end{array} \right\} &= 1\frac{1}{2} \times \frac{1}{1 - \left(\frac{6\cdot8}{6}\right)^2} \\ &= 1\frac{1}{2} \times \frac{1}{1 - 1\cdot28} = 5\frac{1}{3} \text{ degrees (nearly).} \end{aligned}$$

The observed oscillation of the ship, from out to out, at this time was about 7 degrees, and the less magnitude of this oscillation, as compared with that given by the formula, must be accounted for chiefly by the want of absolute uniformity in a sufficiently long series of waves to make the rolling permanent, as well as by the steadying effect of the resistance. The example has, however, been given merely as an illustration of the use of the formula, not as a proof of its accuracy; in practice all deductions from the theory of unresisted rolling, as to the *extent* of oscillation, require to be modified to allow for the effect of fluid resistance.

It is possible, by means of very simple experiments, to illustrate the foregoing cases.* Let AB, Fig. 71, represent a pendulum with a very heavy bob, having a period equal to the half-period of the wave. To its lower end, let a second simple pendulum, BC, be suspended, its weight being inconsiderable as compared with the wave pendulum AB: then, if AB is set in motion, its inertia will be so great that, notwithstanding the suspension of BC, it will go on oscillating very nearly at a constant range—say, equal to the maximum slope of the wave—on each side of the vertical. First suppose BC to be equal in length and period to AB: then, if the compound pendulum is set in motion, and AB moves through a small range, it will be found that BC, by the property of synchronising impulses, is made to oscillate through very large angles. Second, if BC is made very long, and of long period, as compared with AB, it will be found that BC continues to hang nearly vertical while AB swings, just as the ship



* Such experiments were made some years ago by the Author in connection with his lectures at the Royal Naval College.

of comparatively long period remains upright, or nearly so, on the wave. Third, if BC is made very short and of small period, when AB is set moving, BC will always form almost a continuation of AB, just as the quick-moving ship keeps her masts almost parallel to the wave normal. These illustrations appeal to many who cannot follow the reasoning, but can apprehend the facts from the experiments.

Combining all these cases for the ship, except that of synchronism ($T = T_1$), it will be seen that, when T is less than T_1 , the *least* inclination attained must equal the maximum wave slope a ; whereas, when T is greater than T_1 , there is no practical limit to the smallness of θ . Here once more we are brought face to face with the representative cases of the *Miantonomoh* and *Inconstant*, as well as with the most important practical deduction from the modern theory of rolling, viz. that the best possible means, apart from increase in the fluid resistance, of securing steadiness in a seaway, is to give to a ship the longest possible natural period for her still-water oscillations. This deduction it is which has been kept in view in the design of recent war-ships, both English and foreign, and its correctness has already been fully established by numerous observations.

It would be easy to multiply illustrations from the published records of rolling of the ships of the Royal Navy, as well as from those of the French navy; but space prevents us from doing this, and we can only give a few, referring the reader to the original documents for more.* The table already given † furnishes a good illustration of the superior steadiness of ships of long period. Another may

* See *Parliamentary Papers*, "Reports on Channel Squadrons," 1863-68; chap. vii. of Mr. Reed's *Our Ironclad Ships*; the report of the Admiralty Committee on

Designs for Ships of War; and various reports on the behaviour of ships in the French navy.

† See page 199.

be drawn from the observed performances of the representative ships in the Channel Squadron of 1873, as under:—

Ships.	Approximate Natural Periods.	Mean Arcs of Oscillation.
	Seconds.	Degrees.
<i>Beilerophon</i>	6½ to 7	16·9
<i>Minotaur</i>	} 7 to 7½	22·3
<i>Agincourt</i>		16·4
<i>Hercules</i>	8	8·1
<i>Sultan</i>	8·9	6·6

This, it should be understood, is a fairly representative case, and by no means an exceptional one. In the French navy similar results have been obtained; their steadiest ships, the *Océan* class, being the ships of longest period. Almost at the outset of the ironclad reconstruction, the returns from the French experimental squadron of 1863 furnished evidence of the same kind, as the following table shows. The observations were made when the vessels were running broadside-on to a heavy sea.

Ships.	Approximate Natural Periods.	Mean Arcs of Oscillation.
	Seconds.	Degrees.
<i>Normandie</i>	} 5 to 5½	43·6
<i>Invincible</i>		41·4
<i>Couronne</i>	6	37·7
<i>Magenta</i>	} 7 to 7½	36
<i>Solferino</i>		35

The *Magenta* and *Solferino* were making only ten oscillations per minute, whereas the other ships were making twelve.

Records of rolling have been mostly limited to the behaviour of ironclad ships, the apprehensions entertained in some quarters as to the unseaworthiness and bad behaviour of these vessels having caused greater attention to be bestowed upon them than upon unarmoured vessels. But now

that rolling returns have been ordered to be made in all her Majesty's ships, a large mass of facts relating to unarmoured as well as armoured ships has been collected, and is continually being increased. The Detached Squadron has in this way enabled a good comparison to be made between the behaviour of the early types of screw frigates, forming the main strength of the squadron, and that of the swift cruisers which have been in company—particularly the *Inconstant* and the *Raleigh*. Allusion has already been made to the wonderful steadiness of the *Inconstant*, which has a long period, and the *Raleigh* has won a similarly good character, as the following specimen of her comparative performances will show. It is taken from the observations of rolling made in the heaviest weather, experienced by the squadron in the spring of 1875, and, like the other examples given, is only a specimen of many similar cases.

Ships.	Approximate Natural Periods.	Mean Arcs of Oscillation.
	Seconds.	Degrees
<i>Newcastle</i>	} 5 }	29·6
<i>Topaze</i>		22·6
<i>Immortalité</i>		20
<i>Narcissus</i>		19·6
<i>Doris</i>		18·7
<i>Raleigh</i>	8	5·8

Experience teaches that the quickest-rolling ships are also the heaviest rollers; which is only the converse statement to the deduction from theory which has now been illustrated. Perhaps the importance of the slower motion being associated with the smaller arc of oscillation may, however, appear more clearly from one or two simple illustrations. In the table on page 199, compare the behaviour of the *Lord Warden* with that of the *Hercules*; the former rolling through an arc of 62 degrees about eleven or twelve times each minute, while the latter rolled through 25 degrees only about seven or eight times each minute. A man aloft, say, at a height of 100 feet, in the *Lord Warden* would be swept

through the air at a mean rate of some 1200 feet per minute, having the direction of his motion reversed about every 5 seconds; whereas a man placed as high in the *Hercules* would only be moving at a mean rate of some 350 feet per minute, and be subjected to a reversal of the direction only about once every 8 seconds. The maximum rates in passing through the vertical would be greater than these mean rates; but it is needless to dwell further upon the contrast. Hereafter it will be shown how great are the strains brought upon the structure, masts, and rigging of ships which roll violently and rapidly; but for the present purpose the foregoing figures must suffice. The reader will have no difficulty in multiplying illustrations of the fact, should he so desire.

The remarks on wave genesis made in the previous chapter will assist the explanation of the undoubtedly greater average steadiness of vessels of long natural periods. What may be termed ordinary storm winds may by their continued action produce waves having lengths of 600 feet or under, with periods of 10 to 11 seconds or less; and these waves would have half-periods about equal to the still-water periods of the wooden screw frigates of the older type and the converted ironclads. Extraordinary conditions would, on the other hand, be required to produce waves having periods double the still-water periods now commonly given to the largest war-ships armoured and unarmoured; for these waves would be from 1200 to 1500 feet in length—sizes that have been noted, but are not often encountered. Before such waves could have reached these enormous dimensions, they must probably have passed through a condition resembling that of the ordinary storm wave; and although, in becoming degraded, they may lose in their lengths much more slowly than they do their heights, yet they may once more, before dying out, approach the lengths and periods of the ordinary storm wave, being less steep than that wave when fully grown. A severe and long continued storm must have taken place to produce the waves

of very long periods synchronising with the times of the double roll of recent ships; and the continued existence of such enormous waves is not likely to be of long duration. Summing up, therefore, it appears probable that the ship of long period (say 7 to 9 seconds) will much less frequently fall in with waves synchronising with her own natural period than will the vessel of shorter period (say 4 to 6 seconds); and when these large waves are encountered, their chance of continuance is much less than that of smaller waves; so that on both sides the slower-moving ship gains, when rolling passively in the trough of the sea.

Changes of course and speed of the ship relatively to the waves, as before explained, affect the relation between the periods, and may either destroy or produce the critical condition of synchronism. But this is equally true of both classes of ship, and as long as they remain under control, all ships may have their behaviour largely influenced by such changes, whether their period be long or short. When synchronism is the result of obliquity of course relatively to the waves, it implies the retention of control over the vessel by her commander; for when she becomes unmanageable, a vessel falls off into the trough of the sea. Hence such synchronism in the case of vessels of naturally long period may be easily avoided by change of course; for them rolling passively broadside-on to the longest waves of ordinary occurrence is not the worst condition (see previous case of the *Devastation*). On the contrary, the vessels of shorter period would occupy their worst position relatively to such waves when rolling passively in the trough of the sea. In short, synchronism of periods usually results only from obliquity of course in the vessels of long period; it can only be avoided in storms of average severity by obliquity of course in the quicker-moving ships. The contrast of conditions speaks for itself.

One other important point of difference between very long waves and ordinary large storm waves is the much less comparative steepness of the former. The fact was illustrated in

the previous chapter; its bearing upon the behaviour of ships will be obvious if the previous remarks on the influence of the maximum wave slope are recalled to mind. It has been shown that the upper limit attained during rolling motion is very largely governed by that slope, as well as by the ratio of the periods. Hence, for a certain fixed ratio of periods, that ship will fare best which encounters the flattest and longest waves. Waves so low in proportion to their length as to form a smooth or gentle swell having periods of 13 or 14 seconds and upwards are not uncommon. During the passage of the *Devastation* to the Mediterranean, for example, such waves were observed, having lengths of nearly 900 feet, heights of only 5 to 10 feet, and a maximum slope of not more than 2 degrees. Probably few waves having these large periods have slopes exceeding 4 or 5 degrees; whereas waves having periods of 8 or 10 seconds have been observed to slope 9 or 10 degrees to the horizon; and it is such waves which would approximate to synchronism with the double period for the greater number of ships.

Another deduction from the general theoretical equation for unresisted rolling is that, when the natural period of the ship is not equal to the half-period of the waves, and when the rolling has not assumed the "permanent" type, the oscillations of the ship will pass through "phases." Equal inclinations to the vertical will recur at regular stated intervals, and the range of the oscillations included in any series will gradually grow from the minimum to the maximum, after attaining which it will once more decrease. Here again observation fully confirms theory: in any set of observations reaching over 5 or 10 minutes, such as are commonly made in the Royal Navy, the minimum inclinations reached will always be found to differ considerably from the maximum inclinations, and the *mean* oscillation is frequently only a little more than half the maximum oscillation. Take, for instance, the following facts from the Detached Squadron, supplementing those on page 206.

Ships.	Mean Arcs of Oscillation.	Maximum Arcs of Oscillation.
	Degrees.	Degrees.
<i>Newcastle</i>	29·6	58
<i>Topaze</i>	22·6	50
<i>Immortalité</i>	20	39
<i>Narcissus</i>	19·6	36
<i>Doris</i>	18·7	48
<i>Raleigh</i>	5·8	15

Similarly, we may supplement the table for the ships of the Channel Squadron on page 205 with the following facts illustrating the phases of oscillation.

Ships.	Mean Arcs of Oscillation.	Maximum Arcs of Oscillation.
	Degrees.	Degrees.
<i>Bellerophon</i>	18·9	25
<i>Minotaur</i>	22·3	46
<i>Agincourt</i>	16·4	37
<i>Hercules</i>	8·1	14
<i>Sultan</i>	6·6	12

The time occupied in the completion of a phase depends upon the ratio of the natural period of the ship to the wave period. If T = ship's period for a single roll, T_1 = half-period of wave, and the ratio of T to T_1 be expressed in the form $\frac{p}{q}$, where both numerator (p) and denominator (q) are the lowest *whole numbers* that will express the ratio: then

$$\left. \begin{array}{l} \text{Time occupied in the completion} \\ \text{of a phase} \end{array} \right\} = 2q \cdot T \text{ seconds.}$$

For example, the waves that produced the rolling recorded in the above table for the Channel Squadron probably had a period of about 9 seconds, or $T_1 = 4\frac{1}{2}$ seconds. For the *Minotaur* $T = 7\frac{1}{2}$ seconds (suppose):

$$\text{Then } \frac{T}{T_1} = \frac{7\frac{1}{2}}{4\frac{1}{2}} = \frac{15}{9} = \frac{5}{3} = \frac{p}{q}.$$

Time for completion of phase = $3 \times 2 \times 7\frac{1}{2} = 45$ seconds.

For the *Sultan*, $T = 8\frac{3}{4}$ seconds (nearly); so that we find

$$\frac{T}{T_1} = \frac{8\frac{3}{4}}{4\frac{1}{2}} = \frac{35}{18} = \frac{p}{q}.$$

Time occupied in completion of phase = $2 \times 18 \times 8\frac{3}{4}$ seconds
 = 315 seconds.

It has been stated that the custom in the Royal Navy is to continue the observations over an interval of ten minutes; and the phase of rolling is practically certain to be completed within that time. But in every case the officer making the observations can ascertain from the comparison of successive oscillations in a series whether the phase is completed or not.

In comparing the rolling of ships, it is usual to take the mean arcs of oscillation (i.e. the mean of the sums of successive inclinations on either side of the vertical), as has been done in this chapter, and on the whole this appears the fairest course. But in analysing rolling returns, it is always desirable to look further, and note the maximum and minimum oscillations, as well as the rate of growth of the range. All these particulars are readily ascertainable from the forms upon which the records of rolling are kept in the Royal Navy. For considerations of safety, the maximum angle of inclination reached is obviously of the greatest importance; but usually it is taken for granted that vessels will not roll so heavily as to be liable to capsize, and, apart from this danger, the mean oscillations afford the best means of comparing the behaviour of ships.

The reader will not fail to remark that the stability or instability of a ship rolling amongst waves must be estimated, not by her inclination to the *vertical* at any period of her motion, but by her inclination to the *instantaneous position of the wave normal*, which has been shown to be her "virtual upright" or instantaneous position of equilibrium. The distinction is important: a moderate inclination to the upright may occur simultaneously with such an inclination

of the wave normal as will imperil the ship. A case of this

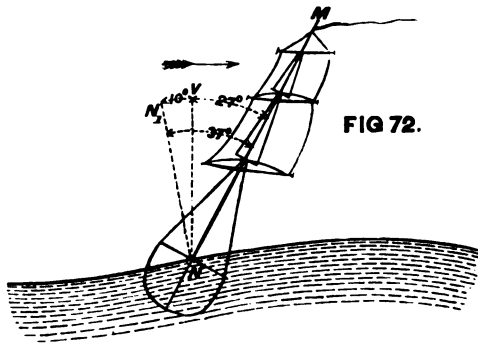


FIG 72.

kind is illustrated in Fig. 72. NN_1 shows the direction of the wave normal, which is inclined 10 degrees on one side of the vertical NV , while the masts of the ship are inclined 27

degrees on the other, so that the sum of these inclinations, 37 degrees, must be taken in estimating the instantaneous righting moment. Remembering what has been said of the steepnesses of waves, it is not unreasonable to take 8 or 10 degrees as the value of the maximum inclination of the normal to the vertical, and in considering the sufficiency of the range of the curve of stability for any vessel, it is desirable to regard it as abridged by this 8 or 10 degrees, in order to allow for the wave slope. When, as with low-freeboard vessels, the total range is very small, this allowance becomes proportionately very large. For example, in the case of the *Glatton* (for which Fig. 47, page 101, shows the curve of stability), this would leave a range of less than 40 degrees. On the other hand, nearly all these vessels of low freeboard are mastless, and therefore not liable to the sudden impulses to which rigged ships are subjected.

A ship with sail-power, besides having provision made for resisting the heave of the sea, like a mastless ship, must be capable of resisting the heeling action of a steady force of wind continuously applied, as well as the impulsive action of gusts and squalls. For all these reasons a rigged ship requires a greater range of stability than a vessel of the mastless type, and a glance at the curves of the typical ships in Fig. 47 will show that in all the types of rigged

war-ships therein represented, except the ill-fated *Captain*, this condition was complied with. In her case, however, the range of stability was very moderate: her initial stability not great, and her sail spread large for an ironclad, all of which causes contributed to her capsizing. Without discussing the circumstances further, it may be interesting to make use of the ship for purposes of illustration, since we have very full published accounts of her qualities.

Suppose the *Captain*, with no sail set, to have floated on a wave 400 feet long and 22 feet high, having a maximum surface slope of about 10 degrees. The total range of stability for the ship (see curve 10 in Fig. 47) being 54 degrees, if the allowance of 10 degrees be made for wave slope, there will remain 44 degrees, measuring the inclination to the vertical, which the ship would have to reach before she became unstable. Under the assumed conditions with sails furled, there would have been little or no risk of her reaching such an inclination, the *Captain* having proved herself to be a well-behaved ship in a seaway.*

· Next take the case where sail is set, and the ship is acted upon by a *steady pressure of wind which in still water* would keep her at a steady angle of heel, say, of 10 degrees; this is within the truth, as it appears from the official reports that, on the day before she was lost, the *Captain* heeled from 10 to 14 degrees under canvas. We have already discussed the case where the *Captain* is sailing at a steady heel of 10 degrees in still water, and Fig. 55, page 137, illustrates it. CD is the "wind curve," indicating the inclining effect of the wind on the sails for different angles of heel; and if by any means the vessel, which has been sailing at a heel of 10 degrees, is carried over to a greater inclination, the wind will follow, and always absorb that part of the area OCDPO of the curve of stability lying between the line CD and the axis of abscissæ (or "base-

* See the reports by Admiral Sir T. M. Symonds on the trials made of the *Captain* with the Channel Squadrons.

line") OP. It will be observed that the wind curve cuts the curve of stability at an inclination of 47 degrees, marked by the ordinate DD_1 ; so that the same force of wind that will steadily heel the ship 10 degrees will also hold her at 47 degrees, where she will be on the verge of safety. The effective range of the curve of stability, excluding the part absorbed by the steady force of wind, is therefore about 37 degrees only, that being the limit of inclination to the vertical which the ship can reach without being blown over when floating at mid-height on the wave. The decrease of 17 degrees from the total range, thus shown to be requisite to provide for the steady action of the wind and the wave slope, is a very serious matter. Apart from gusts and squalls, there would still be a good provision for safety, taking into account the steadiness of the ship; but even ships reputed steady occasionally roll as much as this, and if the *Captain* had reached a position 10 degrees beyond that indicated in Fig. 72, she would have been on the point of capsizing. With steeper waves having a greater slope, the capsizing point would be sooner reached. In Mr. Childers' minute on the loss of the *Captain* (pages 56 and 57) will be found similar illustrations to the foregoing, only on waves of very exceptional steepness, 200 feet long, 23 feet high, and having a maximum slope of 20 degrees; then, supposing the *Captain* to be subjected to a steady wind capable of inclining her 8 degrees in still water, it is estimated that only 21 degrees' inclination to the vertical would suffice to bring her to the verge of capsizing. Reverting to Fig. 55, and taking the case of the *Monarch* exposed to a force of wind equal to that assumed to act on the *Captain*, it will be seen that, after providing for the steady action of the wind, there remains an available range (KW) of over 55 degrees, after allowing 10 degrees for the wave slope, instead of 37 degrees, as in the *Captain* under identical circumstances. From these two cases it will be evident that good range in the curve of stability is of the highest importance in rigged ships.

Adding to these considerations of steady wind pressure

that of the effect of squalls or gusts of wind, the danger of capsizing is evidently much increased. What was said respecting the action of gusts on a rigged ship rolling in still water does not exactly apply here, because the wave normal, with respect to which the instantaneous righting moment has to be estimated, is constantly changing its position, while the wind maintains its horizontal direction. Various attempts have been made to deal with this problem, but none of them are entirely satisfactory. For our present purpose it will therefore suffice to say generally that the sudden action of the wind upon the sails, coming, as it may, at the extreme of the roll to windward, must tend to increase the return roll to leeward, beyond the range which would be attained under the action of the waves alone, or of the waves and the steadily applied wind. A range of stability sufficient to provide against such impulsive actions ought to be secured in all rigged ships; and experience leads to the conclusion that, to secure a proper margin of safety, the range of the curves of stability for such ships ought to be at least 70 or 80 degrees. The Admiralty Committee on Designs fixed 50 degrees as the minimum range to be desired in the curves of stability for mastless ships; so that the range named for rigged ships is about 50 per cent. greater. It will be understood that these limiting values of the range of stability are not direct deductions from theory, but rules based upon experience, and probably providing a reasonable margin of safety.

It has been shown that a ship accompanying the motion of the waves, and heaving vertically, is subjected to accelerating forces which affect her apparent weight, just as similar accelerating forces affect the pressure of the water in the wave. Actual observations have proved the apparent weight of a ship to have varied about 20 per cent. above and below the true weight;* and the importance of this variation must not be overlooked, because the righting moment at

* See remarks made on page 155.

any instant involves as a factor the apparent weight, which may be above or below the true weight. Take the case where it is less than the true weight—i.e. the upper half of the orbits, or the upper half of the waves. Then, since the force of the wind is not affected by the wave motion, it must during this time have a greater inclining effect upon the vessel than the same force of wind would have in still water; and in vessels of low freeboard, such as the *Captain*, where the curve of stability is exceptionally small in area, and flat-topped (see Fig. 47), this virtual loss of righting moment due to the vertical heaving motion may prove another cause of danger. Of course, in the lower half of the orbit the apparent weights and the instantaneous righting moments are greater instead of less than in still water. And it must also be remembered that for a ship on a wave the vertical accelerating forces become zero, the true weight being the apparent weight, at nearly the same time that the wave normal reaches its maximum inclination (as in Fig. 72). Both these are circumstances telling in favour of the ship; but at the same time the subject now briefly mentioned is certainly one deserving attention in discussions of the safety of rigged ships rolling amongst waves.

Only a passing notice has been bestowed hitherto upon the very important effects of fluid resistance in modifying the rolling of ships among waves. This branch of the subject is, however, of great interest, and has attracted the attention of several able investigators: although they are not agreed in all points, there are many general considerations which command universal support; to some of these, brief reference will now be made.

The deductions from the hypothetical case of *unresisted* rolling, which is mainly discussed in the modern theory, can be regarded only as of a qualitative and not of a quantitative character. For example, one of these deductions is that a ship rolling unresistedly among waves having a period double her own natural period will accumulate great rolling motion, and infallibly upset. As a matter of fact, we know



that, while the assumed ratio of periods leads to the production of heavy rolling, ships do not commonly, nor in any but exceptional cases, upset under the condition of synchronism ; in other words, the *character* of the motion is well described by the deduction from the hypothetical case, but its *extent* is not thus to be measured. Similarly, in other cases, the effect of resistance must be considered when exact measures of the range of oscillation are required, as they may be in discussing the safety of ships. The problem, therefore, resolves itself into one of correcting the deductions from the case of unresisted rolling, by the consideration of resistance coming into play.

— In accordance with the principles explained in Chapter IV., it is possible by means of still-water rolling experiments to ascertain the moment of resistance of a ship corresponding to any assigned arc of oscillation. If the ship herself has not been rolled for that purpose, but a sister ship or similar vessel has been so rolled, her coefficients of resistance may be estimated with close approximation, and the retarding effect of resistance may be determined. This is true within the limits of oscillation reached by the still-water experiments, say, 10 or 15 degrees on each side of the vertical, and in high-sided ships of ordinary form the limits may probably be extended. In fact, it may be assumed that the coefficients of resistance for most ships are or may be ascertained by these rolling experiments, for inclinations as great as are likely to be reached by the same ships when rolling in a seaway, in all but exceptional circumstances.

If a vessel rolls through a certain arc amongst waves, it appears reasonable to suppose that the effect of resistance will be practically the same as that experienced by the ship when rolling through an equal arc in still water. The intrusion of the vessel into the wave, as already remarked, must somewhat modify the internal molecular forces, and she must sustain certain reactions, but for practical purposes these may be disregarded, not being proportionally large.

Resistance is always a retarding force ; in still water it

tends to extinguish oscillation ; amongst waves it tends to limit the maximum range attained by the oscillating ship. This may be well seen in the critical case of synchronism ; where a ship rolling unresistedly would have a definite addition made to her oscillation by the passage of each wave. The wave impulse may be measured by the added oscillation ; the dynamical stability corresponding to the increased range expressing the "energy" of the wave impulse. At first the oscillations are of such moderate extent that the angular velocity is small, and the wave impulse more than overcomes the effect of the resistance ; the rolling becoming heavier. As it becomes heavier, so does the angular velocity increase, and with it the resistance ; at length, therefore, the resistance will have increased so much as to balance the increase of dynamical stability corresponding to the wave impulse—then the growth of oscillation ceases. As successive waves pass the ship after this result is attained, they each deliver their impulse as before, but their action is absorbed in counteracting the tendency of the resistance to retard and degrade the oscillations.

When a ship is rolling "permanently" amongst waves, her oscillations having a fixed range and period, a similar balance will probably have been established between the wave impulse and the resistance ; and here also the actual limit of range will fall below the theoretical limit given by the formula for unresisted permanent rolling on page 201. Resistance may, in this case, be viewed as equivalent to a reduction in the *steepness* of the waves ; this diminished slope taking the place of what has been termed the "effective slope" for unresisted rolling. Hence it will be seen why the general deductions from the theory of unresisted rolling are so well borne out by experience with actual ships whose behaviour is largely influenced by resistance.

Mr. Froude has approached in this way the problem of determining the maximum range likely to be attained by ships of known natural period rolling amongst waves of known dimensions ; making an allowance from the actual steepness

of the wave, in order to provide what he terms the "maintaining power" required to balance the resistance, and using the remaining wave as that which for unresisted rolling would produce oscillations similar to those actually performed by the ship. These, however, are matters lying outside the scope of the present work, and they cannot be pursued further. The broad practical deduction is that increased resistance acts beneficially on a ship by limiting her maximum oscillations, and the correctness of this deduction, although formerly it was disputed by some high authorities in the science of naval architecture, has now been placed beyond doubt.

The Admiralty Committee on Designs took evidence in 1871 as to the advantages or otherwise of bilge-keels; this evidence was not unanimously favourable to the use of such keels, but its general tenour was so. Some of the Indian troop-ships had been fitted with deep bilge-keels at that time, and the reports on their effect on the behaviour of the ships were most definite. The captain of the *Serapis* reported that the bilge-keels, having been tried under all conditions of wind and sea, had proved a perfect success, and added, "I can confidently say her rolling has been lessened 10 degrees each way." As regarded the *Crocodile*, no similarly severe tests had at that time been made, but the opinion was confidently expressed that "the rolling had been much checked by the "bilge pieces," the ship having often rolled heavily before they were fitted, and being considered "remarkably steady" afterwards. Mr. Froude also came forward with the reports of his experiments on models, and strongly recommended the use of deep bilge-keels, a recommendation which was endorsed by the committee in their report.

The experiments of Mr. Froude were made at Spithead with the same model of the *Devastation* as had previously been used to determine the effects of different depths of bilge-keels upon still-water oscillations.* At the time considerable doubt was entertained in some quarters as to

* See the accounts of these experiments at page 125.

the safety of the *Devastation*; and it was intended to try the model amongst waves having approximately the same period as its own for a double roll, in order to obtain a verification of the theoretical investigations of the probable behaviour of the ship when similarly circumstanced. Waves were found having the desired period, but they proved to be proportionately much steeper than any waves would be that would synchronise with the double period of the ship. Hence the trials became simply a test of the relative merits of the different bilge-keels, and in no sense a representation of the probable behaviour of the ship. The results were found to be as follows:—

Condition of Model.	Maximum Angle attained.
With 6 feet bilge-keel on each side	5 degrees.
„ 3 feet „ „	13½ „
„ no bilge-keels	Model upset.

The deeper bilge-keels, therefore, proved very influential in limiting the range of oscillation, the waves remaining of the same character, and the variations in the depths of the keels being the only changes made during the trials.

The most complete evidence of the usefulness of bilge-keels in limiting the rolling of ships in a seaway is that afforded by the experiments made off Plymouth in 1872 by Mr. Froude. Two sloops, the *Greyhound* and *Perseus*, had been placed by the Admiralty at the disposal of Mr. Froude for this purpose; the *Greyhound* was fitted with temporary bilge-keels about 3½ feet deep, which were not supplied to the *Perseus*. So far as external form and dimensions were concerned, the two vessels were very similar; and by means of ballast they were made to have practically the same draught of water and still-water period; the latter being about 4 seconds for a single roll. With the one exception of the bilge-keels, the conditions influencing the behaviour of the two ships were thus made as nearly as

possible identical; and their comparative rolling, when exposed to the same series of waves simultaneously, necessarily afforded a measure of the effect of the bilge-keels. When the trials were made, the waves were of moderate length, and from 4 to 5 seconds' period; the two vessels were towed out and placed broadside-on to the waves, in immediate neighbourhood, but not so close to one another as to favour one by any shelter from the other. Their simultaneous rolling was then observed, and the *Perseus* was found to reach a *maximum* roll about twice as great as that for the *Greyhound*; the proportions for the mean oscillations of the two ships being much the same as those of the maximum. Thus, taking twenty successive rolls, the mean for the *Greyhound* was less than 6 degrees, whereas that for the *Perseus* was 11 degrees; the maximum inclination of the *Greyhound* during this period was about 7 degrees, that for the *Perseus* about 16 degrees. Comment upon these facts is needless.

The accidental loss of a portion of one of the temporary bilge-keels attached to the *Greyhound* at the end of these trials furnished an unlooked-for illustration of their beneficial effect. Such a loss would not have occurred in a vessel with permanent bilge-keels, but the deep bilge-keels in the *Greyhound*, being fitted for experimental purposes only, were not very strongly secured to the hull, and a portion of one gave way. Its loss was not known to Mr. Froude until afterwards, but it was noticed that the behaviour of the ship had sustained a sudden change, the rolling being more heavy than before; and the cause could not be detected until the detached portion of the bilge-keel was seen floating alongside.

This careful and conclusive series of experiments does not, of course, fairly represent the ordinary conditions of bilge-keel resistance, the depth of the keels fitted to the *Greyhound* being proportionately very great indeed. But it exemplifies what may be accomplished in this direction, and the facts obtained are very valuable for the future guidance of naval architects. Circumstances may and do arise in the designing of war-ships which make it difficult, if not

impossible, to associate requisite qualities with the long still-water period which theory shows to be advantageous. In such cases, steadiness may be secured by the increase of bilge-keel resistance, in association with a moderately long still-water period. The good behaviour of the *Devastation* in her trials with the *Sultan* was undoubtedly due in part to her deep bilge-keels; for the *Sultan* has a still-water period nearly 30 per cent. longer than that of the *Devastation*, and with equal bilge-keel resistance should be much the steadier ship. The less bilge-keel resistance of the *Sultan*, however, decreased the relative effect of her longer period, and so far as the trials off Berehaven went, the *Devastation* compared very favourably indeed with the ironclad which has, perhaps, the greatest reputation for steadiness of any armoured ship afloat. These trials were not so extensive as to completely settle the relative steadiness of the two ships; but they furnished conclusive evidence of the advantages resulting from the use of deep bilge-keels in the *Devastation*, and thence of their advantages if fitted to other ships. The use of bilge-keels is no novelty in the Royal Navy; they have been commonly fitted throughout the period of the ironclad reconstruction. The depths recently employed have, however, been greater than those formerly adopted, with a correspondingly increased effect in preventing the accumulation of rolling motion. Care has, of course, to be exercised in fitting these bilge-keels in order that they may not interfere with the speed or steering of the ship; and it is customary to fit them only over about one-half of the length of the ship, keeping them on the middle part of the length, and leaving the extremities free from such appendages.

It need hardly be added that, in making these lengthy references to bilge-keel resistance, it is not intended to pass by the fact that the form of the immersed part of a ship and the condition of her bottom very considerably affect the aggregate resistance. But all these conditions are included in the determination of the coefficients of resistance to rolling; and, moreover, the form of a ship is determined by the

naval architect mainly with reference to its carrying power and propulsion, not with reference to the increase of the resistance to rolling. This latter is a subordinate feature of the design, and is best effected by leaving the under-water form of the ship herself unaltered, and simply adding bilge-keels. The depths of these keels should be made as great as possible consistently with the conditions of service of the ship, the sizes of the docks she has to enter, or other special circumstances.

Certain classes of ships present singular features considerably affecting their behaviour at sea. Vessels with projecting armour, like the American monitors, or the *Glatton* in the Royal Navy, or the *Devastation* class as they were originally designed, really possess in these projections virtual side-keels of great efficiency in adding to the resistance to rolling; and the records of the behaviour of American monitors prove that the projections had a steadying effect. There was, however, the drawback that the alternate emersion and immersion of the armour shelf brought considerable shocks or blows upon the under side of the projecting armour, tending to shake and distress the fastenings of these singularly constructed vessels. Similar shocks were experienced in the *Devastation* when rolling in a seaway, although the vastly different construction of the armoured side prevented any injurious effects similar to those said to have been experienced in the American monitors. After several trials it was decided to "fill-in" the projection of the armour shelf in the *Devastation* in order to avoid the shocks; the reduction of the resistance being accepted when it had been ascertained beyond question that the vessel was singularly steady and well behaved.

Low freeboard also, as previously explained, develops deck resistance by the immersion and emersion of the one or other side that accompanies moderate angles of rolling. Mr. Froude has shown by his trials with the *Devastation* model how very influential in checking rolling this deck resistance is when the vessel rolls in smooth water; and

observations of the behaviour of monitors amongst waves have clearly shown that conditions similar to those of still water obtain also for rolling amongst waves. In vessels of ordinary forms and good freeboard nothing similar to this deck resistance exists; and therefore in monitors the use of bilge-keels is not so necessary as it is in ordinary vessels.

The steadying effect of sails upon ships rolling in a sea-way is a matter of common experience; it is chiefly due to the resistance developed by the rapid motion of the sails through the air as the ship rolls. This motion of the sails must, of course, be estimated relatively to that of the wind. As the vessel rolls to leeward, there is a virtual loss of the wind pressure on the sails, due to the relative velocity, being the *difference* of the velocities of the wind and the sails; whereas, when she rolls to windward, the relative velocity is determined by the *sum* of these two velocities, and there is a virtual increase of the wind pressure on the sails, as compared with the case where the vessel is sailing at a steady heel. A vessel under sail therefore commonly oscillates about some position of mean inclination lying to leeward of her steady angle of heel in still water for the same pressure of wind, and often does not pass to the windward side of the vertical. But the steadying effect is obtained in association with a liability to large angles of inclination being reached in consequence of the sudden action of gusts or squalls of wind upon the sails, as explained in a previous part of this chapter. And on the whole this latter aspect of the influence of sail-power on the behaviour of ships appears the more important.

Little need be said respecting the longitudinal oscillations of pitching and 'scrending' experienced by ships among waves. The great longitudinal stability of ordinary ships renders it difficult to establish these oscillations in still water for purposes of experiment. One or two small ships have been made to oscillate longitudinally in order to ascertain the period; and it appears that for short, broad vessels this period is about three-fourths the period for transverse oscillation.

Other observations made in a moderate seaway appear to show that the period for pitching oscillations in ships of greater proportions of length to beam is from two-thirds to one-half that for rolling. But we neither possess nor do we require experimental data, relating to the still-water periods for longitudinal oscillations, similar to those for transverse oscillations, on the importance of which stress has been laid. It may be taken for granted that, as a rule, the effect upon the period of the great height of the longitudinal metacentre above the centre of gravity of a ship more than counterbalances the effect of the increased moment of inertia for longitudinal oscillations, the period of such oscillations being *less* than the period for transverse oscillations.* In the Russian circular ships the two periods must be nearly equal.

The existence of waves supplies a disturbing force capable of setting up the longitudinal oscillations; this is a matter of fact, and it is easily accounted for. Suppose a ship to be placed bow-on to an advancing wave; its slope will at the outset rise upon the foremost part of the ship above the water-level in still water; and perhaps simultaneously at the after part of the ship the wave profile may fall below the still-water level. The obvious tendency of the bow will be to rise under the action of the surplus buoyancy at that part, the stern falling relatively; that is to say, a 'scending motion will be established, and its initial rate will depend upon the still-water period for longitudinal oscillations. After the wave crest has passed the bow of the ship, supposing for the instant that the wave is long as compared with the length of the ship, there will probably be a reversal

* Apart from resistance, the formula for the period of longitudinal oscillations takes the same form as that given at page 113 for the period of rolling; only the height, m , must be equal to the height of the longitudinal metacentre above

the centre of gravity, and the radius of gyration, k , must be estimated by multiplying each element of weight by the square of its distance from the transverse axis passing through the centre of gravity.

of the conditions. The wave profile on the back slope of the wave would probably fall below the still-water load-line at the bow, and this excess of weight over buoyancy would tend to check 'scending and cause pitching to begin. The motion thus created by the passage of the first wave would of course be modified by the passage of succeeding waves in the series ; and in the end there would probably be established a certain phase of pitching and 'scending oscillations, corresponding in character to the phases of rolling described above.

This is the simplest case that can be chosen, and it by no means represents all the conditions of the problem ; but it shows how the existence of waves and their passage past a ship lead to disturbances of the conditions of equilibrium existing in still water, and to the creation of accelerating forces due to the excess or defect of buoyancy. No account has here been taken of the variations in the direction and magnitude of the fluid pressure at different parts of the wave ; although these variations would undoubtedly produce some modification in the behaviour of the ship, the modification would not be likely to change the *character* of the motion, with which alone we are at present concerned.

This illustration also shows that the following are the chief causes influencing the pitching and 'scending of ships : (1) the relative length of the waves and the ships ; (2) the relation between the natural period (for longitudinal oscillations) of the ship and the apparent period of the waves, this apparent period being influenced by the course and speed of the ship in the manner previously explained ; (3) the form of the wave profile, i.e. its steepness ; (4) the form of the ship, especially near the bow and stern, in the neighbourhood of the still-water load-line, this form being influential in determining the amounts of the excesses or defects of buoyancy corresponding to the departure of the wave profile from coincidence with that line ; (5) the longitudinal distribution of the weights, determining the moment of inertia. In addition, it need hardly be said that fluid resistance exercises a

most important influence in limiting the range of the oscillations; this resistance is governed by the form of the ship, and particularly by that of the extremities, where parts lying above the still-water load-line are immersed more or less as the ship pitches and 'scends, and therefore contribute to the resistance.

This summary requires but few comments. It is obvious that, when the length of a ship is great as compared with the wave length, there is no probability of extensive pitching motions being produced. The *Great Eastern*, for example, with her length of 680 feet, could span from crest to crest even on the very large Atlantic storm waves observed by Dr. Scoresby; and on storm waves of common occurrence she might be floating simultaneously on three of them. Even less imposing structures, such as the largest ships of the Royal Navy, with lengths of 300 to 400 feet, are long as compared with ordinary storm waves, and therefore are not likely, as a rule, to accumulate large angles of pitching—a conclusion borne out by experience. Small vessels may, of course, fall in with waves which are long relatively to their own lengths; but in such cases it is a common observation that the vessels "float like ducks on the water"—that is to say, their natural periods for longitudinal oscillations are so small as compared with the wave period that they can very closely accompany the motions of those parts of the wave slope upon which they float. In fact, their condition furnishes a parallel to the case of the little raft in Fig. 62, except that the raft follows the upper surface of the wave, whereas the ship, stretching over a considerable length on the wave, and penetrating to some depth in it, does not follow the upper surface, but, as it were, averages the slope of a portion of a subsurface corresponding to her own length.

According to theory, the case of pitching is best dealt with in a manner similar to that adopted for rolling motions. The ship is supposed at every instant to have a tendency to move towards an instantaneous position of equilibrium which is a normal to her "effective wave slope;" but in the determina-

tion of this effective slope for longitudinal oscillations greater difficulties are encountered than in the similar problem for rolling. One thing, however, is evident, even in the case where the length of the wave is great as compared with that of the ship, viz. that the steepness of the effective slope will be much less than the maximum slope of the upper surface, both because of the length along the wave which the ship occupies and of the depth to which she is immersed in it. Supposing her to be in the worst position, with the middle of her length at the steepest inclination of the wave, the slope of the surface to the horizon, at the places occupied by the bow and stern, will be much less than the maximum slope; and, further, as remarked previously, all subsurface trochoids in the wave are less steep than the upper surface. The effective slope has to be the resultant of these varying conditions, and must therefore be much less steep than the maximum surface slope. But even accepting this conclusion, and assuming an effective slope, no practical deductions of importance have yet been drawn from this method of viewing the question, beyond those obtained from general considerations, and stated in the preceding summary.

It has been asserted that in large ships extreme pitching is not likely to occur; but it must be noted that even moderate angles of pitching lead to very considerable linear motions at the extremities of a long ship. For example, in the trials off Berehaven with the *Devastation*, *Agincourt*, and *Sultan*, it is reported that the *Sultan* on one occasion pitched so that the bow appeared buried very deeply in the wave, and observers on the deck of the *Devastation* could not determine whether the sea broke over the forecastle, which is some 30 feet above water when the ship is at rest in still water. Very similar remarks were made on another occasion respecting the *Agincourt*. For each degree of inclination from the upright, however, a point on the bow of the *Agincourt* would move vertically nearly 4 feet, and one on the bow of the *Sultan* about 3 feet; so that

very moderate angles of inclination *in still water* would suffice to bring the forecastle deck close to the water-level. Amongst waves, with their varying slopes into which the bow of a ship plunges, much more moderate inclinations might produce the same apparent effect. For example, the *Devastation* and *Agincourt* were tried steaming head-on to waves from 400 to 650 feet long and from 20 to 26 feet high, the speed of the ships being about 7 knots per hour. The periods of these waves varied from 9 to 11 seconds; their maximum slopes, from $7\frac{1}{2}$ to 9 degrees. Allowing for the speed of the ships, the apparent periods of the waves varied from 7 to 9 seconds, giving apparent half-periods which probably approximated to equality with the natural period (for a single oscillation longitudinally) of the ships. It was a case, therefore, where the conditions were conducive to heavy pitching, and the results of the observations are interesting. The total arcs of oscillation for the *Devastation* were, on an average, 8 degrees only, that is, about 4 degrees on either side of the upright, or about one-half the maximum slope of the surface of the waves; the maximum arc of oscillation was rather less than 12 degrees, about 6 degrees on either side of the upright, about three-fourths the maximum slope of the surface. The *Agincourt* pitched through rather smaller arcs than the *Devastation*, but, supposing her motion to have reached the same maximum, the bow would have been immersed in still water about 20 feet below its normal draught; yet we are assured that a sea broke over the forecastle, which is some 10 feet higher above still water, a circumstance which is attributable to the bow having been plunged into an advancing wave slope. These facts are mentioned in order to enforce the desirability of taking all possible precautions in estimating the extent of pitching; so many of the attendant circumstances tending to exaggerate the apparent motion, and to deceive the observer unless he has recourse to actual measurement of the angular motion. Observations of pitching and 'scending of a trustworthy character are as

yet not very numerous; but the Admiralty instructions provide for such observations to be made when favourable opportunities present themselves, and it is therefore probable that this branch of the subject of the behaviour of ships at sea may before long receive considerable extensions.

Fluid resistance is known to play an important part, as already stated, in limiting the range of pitching oscillations; but the naval architect has not the same control over this feature as he possesses in connection with rolling motions. It would be difficult to fit any appendages equivalent to bilge-keels in order to increase the resistance to longitudinal oscillations; and the under-water forms of ships are settled mainly with reference to their efficient propulsion, the effects of form on pitching usually occupying a subordinate place. Attempts have been made, however, to improve the forms of the bows of the ships in order to lessen pitching; and very diverse opinions have been expressed as to the best form that can be adopted. Many persons are in favour of V-shaped or "flaring" cross-sections; the out-of-water parts having a large volume as compared with the immersed part lying beneath them. Others, including Mr. Reed (late Chief Constructor of the Navy), have strongly objected to flaring bows, and have introduced U-shaped cross-sections, with the view of reducing pitching, as well as of reducing the excess of weight over buoyancy at the bow.* Mr. Reed sums up his reasons for preferring the U form to the V form of cross-section as follows:—"First, it increases the buoyancy " towards the bow, and even in still water reduces the ten-
" dency of the heavy bow to break itself off or to bend the ship
" longitudinally; and, secondly, the bluff vertical sections
" encounter greater upward resistance than the V-shaped
" sections when the ship tends to plunge down through the
" water, and receive a greater lifting effect when the sea tends

* See further on the last-named subject the remarks in Chapter VIII. page 261.

“to rise up under the ship.”* The adoption of pronounced U-shaped sections for the bow has not become general, nor does it appear likely to do so, other considerations leading most naval architects to prefer finer under-water forms; but the use of flaring sections above water is now less common than it was formerly, and naval architects agree that they are undesirable except in special cases, as, for example, where room is required at the bow to work a chase gun on the upper deck.

Pitching oscillations are likely to be more sustained, even if they are not made more extensive, when heavy weights—such as guns or cargo—are carried far forward or aft. This is a matter of common experience, as well as a condition which theory would predict. Carrying heavy weights near the bow and stern instead of nearer amidships adds to the moment of inertia of the ship; this increase leads to a somewhat longer period of oscillation for pitching, but the change is scarcely such as might be expected to exercise a notable influence on the behaviour of most ships, seeing that the periods of the waves which would produce considerable pitching are likely to be large as compared even with the altered period for pitching. On the other hand, the increased moment of inertia, while it opposes greater resistance to motion being impressed on the ship, when once that motion has been set up acts against the fluid resistance, and tends to maintain the motion. A similar condition has already been discussed for the rolling motion of ships, so that nothing more need be added.

Vessels of low freeboard are subjected to deck resistance when pitching among waves; and the *Devastation* furnishes an excellent example of this action. When on trial off the Irish coast, and steaming head to sea at moderate speeds,

* *Naval Science*, No. 12, page 55. The reader may also consult on this subject a paper, by Dr. Woolley, “On the Bows of the *Helicon* and

Salamis,” in vol. vii. of the *Transactions* of the Institution of Naval Architects.

waves broke over the fore part of the deck, as it was anticipated they would do under these circumstances, the fittings on this deck having been designed to exclude from the interior water lodging upon it. An eye-witness, describing her motion, says :—" It invariably happened that the seas broke upon her " during the upward journey of the bow ; and there is no " doubt that to this fact her moderate pitching was mainly due, " as the weight of water on the fore-castle deck, during the " short period it remained there, acted as a retarding force, " preventing the bow from lifting as high as it otherwise " would, and this, of course, limited the succeeding pitch, and " so on." In American monitors, with their exceptionally small freeboard, this kind of action would be even more effective, were it not for the fact, that their natural periods for pitching oscillations are probably so small as to make them capable of accompanying very closely the motions of such waves as would produce considerable pitching in the monitors.* Under-water projections, like the spur-bows of ironclad rams, may also produce some limitation of pitching and 'scending by creating additional resistance; and are said to have actually done so in reports on French ships. But these are cases of comparatively unfrequent occurrence, and are interesting chiefly as instances of the effect of fluid resistance in limiting the pitching motions of ships which immerse or emerge their decks. In ordinary ships the decks are much higher, and the longitudinal oscillations rarely acquire such a magnitude as to immerse the decks considerably.

Finally, on this part of the subject, it may be well to

* Mr. Fox (assistant secretary of the United States navy), reporting on the behaviour of the *Miantonomoh*, head to sea in a heavy Atlantic storm, said, "She takes " over about 4 feet of solid water, " which is broken up as it sweeps " along the deck, and after reaching " the turret is too much spent to

" prevent firing the guns directly " ahead." This confirms the opinion that these vessels move so quickly as to very nearly accompany the wave slope; their actual arcs of oscillation in pitching being considerable, and accurate practice with the guns in the line of keel being impossible.

remark that the actual period observed for pitching motions is not to be taken as equal to the natural period. In the case of rolling, a similar distinction of periods has been explained, and what was there said applies here also. In all probability, the result of more extended observations will show that the periods of the waves which are capable of producing considerable pitching motions practically determine the observed periods of pitching, the natural period being mastered by the wave period just as it is in the case of "permanent" rolling discussed in the earlier part of this chapter.

CHAPTER VII.

METHODS OF OBSERVING THE ROLLING AND PITCHING MOTIONS
OF SHIPS.

ENOUGH has been said in previous pages to show how variable, and how liable to mislead an observer, are the conditions surrounding the behaviour of a ship at sea. The ship, herself in motion, is surrounded by water also in motion; and it is extremely difficult, by means of unaided personal observation, to determine even so apparently simple a matter as the position of the true vertical at any instant. To estimate correctly the angles through which a ship may be rolling or pitching, it is therefore necessary to bring apparatus of some kind into action; and in the use of such apparatus there are many sources of possible error which must be prevented from coming into operation. Upon the correctness of these observations we are greatly dependent, since deductions from theory are thus checked, and the extent to which they can be made a safe guide for the naval architect in designing new ships is ascertained. Numerous examples illustrating the substantial agreement of observation with the chief deductions from theory have been given in the previous chapter; but up to the present time the comparison has been mainly of a qualitative character, and before more exact results are obtained, it will be necessary to have compiled and collated much more exact and extensive records than are at present accessible.

The chief problem to be solved is this. What are the conditions of wave motion that will produce the maximum

oscillation in a ship, of which the still-water period of oscillation as well as the coefficients of resistance are known; and what will be the range of that maximum oscillation? Or, it may be desirable to ascertain generally what extent of motion will be impressed upon a ship by a series of waves of certain assumed dimensions. Pure theory will not be likely to supply correct answers to these questions; but the conclusions of theory, being correct as to the *character* of the motion established, may be modified as to the *extent* of the motion by recorded observations of the behaviour of ships amongst waves of which the particulars have also been observed. To do this in a satisfactory manner, many observations will, as was said, be required; and the freer individual observations are from errors, the more certain will be the process of modification. Methods of observing correctly the lengths, heights, and periods of waves have been described in detail in Chapter V.; and it is now proposed to sketch the methods which have been adopted at various times for observing the rolling and pitching oscillations of ships.

Of these methods, the following are the most important:—

(1) The use of pendulums, with various forms of clinometers; these pendulums having periods of oscillation which are very short as compared with the periods of the ships.

(2) The use of gyroscopic apparatus.

(3) The use of "batten" instruments.

(4) The use of automatic apparatus, such as that employed by Mr. Froude on board the *Devastation*.

Taking these in the order they have been named, it may be well to glance at their chief features, and to indicate the probable correctness or otherwise of their records.

Pendulums, or clinometers, are the simplest instruments, but they are not trustworthy indicators of the angles of inclination attained by a ship when rolling in still water, and much less of those moved through by a ship rolling or pitching at sea. When a ship is held at a steady angle of heel (for example, as shown by Fig. 30, page 64), a

pendulum suspended in her will hang vertically, no matter where its point of suspension may be placed, and will indicate the angle of heel correctly. The only force then acting upon the pendulum is its weight, i.e. the directive force of gravity, the line of action being vertical. But when, instead of being steadily inclined, the ship is made to oscillate in still water, she will turn about an axis, passing through or very near to the centre of gravity;* hence every point not lying in the axis of rotation will be subjected to angular accelerations, similar to those which were described at page 107 for a simple pendulum. Supposing the point of suspension of the clinometer to be either above or below the axis of rotation, it will be subjected to these accelerating forces, as well as to the directive force of gravity, and at each instant, instead of placing itself vertically, the clinometer, or pendulum, will tend to assume a position determined by the resultant of gravity and the accelerating force. As the period of the pendulums used is short as compared with the period of the ship, the position towards which it tends to move will probably be reached very nearly at each instant. The case is, in fact, similar to that represented in Fig. 71, page 203. If the length of the upper pendulum (AB) is supposed to represent the distance from the axis of rotation of the ship to the point of suspension of the pendulum which is intended to denote her inclinations, the clinometer pendulum may be represented by BC. As AB sways from side to side, the point B is subjected to angular accelerations, and these must be compounded with gravity in order to determine the position which BC will assume; for obviously BC will no longer hang vertically. The angular accelerating force reaches its maximum when the extremity of an oscillation is reached, consequently it is at that position that the clinometer will depart furthest from the vertical position. In Fig. 71, suppose VAB to mark the extreme angle of inclination reached by the ship,

* See page 111, Chapter IV.

and let AB be produced to D: then, to an observer on board, the angle CBD will represent the excess of the apparent inclination of the ship to the vertical above the true inclination.

It will be seen that the linear acceleration of the point of suspension B depends upon its distance from the axis of rotation A in Fig. 71. If B coincides with the axis of rotation, it is subjected to no accelerating forces, and a quick-moving pendulum hung very near to the height of the centre of gravity of a ship rolling in still water will, therefore, hang vertically, or nearly so, during the motion, indicating with very close approximation the true angles of inclination. Hence this valuable practical rule: when a ship is rolling in still water, if a pendulum is used to note the angles of inclination, it should be hung at the height of the centre of gravity of the ship; for if hung above or below that position, it will indicate greater angles than are really rolled through, the error of the indications increasing with the distance of the point of suspension from the axis of rotation and the rapidity of the rolling motion of the ship.

The errors of the pendulum indications for still-water oscillations may be approximately estimated from the following formula, which was proposed by Mr. Froude:—

Let a = true angle of inclination reached by the ship;

β = apparent angle of inclination indicated by the pendulum;

T = period of oscillation (in seconds) for the ship;

h = the distance of the point of suspension of the pendulum above the centre of gravity of the ship:

Then
$$a = \frac{3.27 T^2}{3.27 T^2 + h} \times \beta.$$

If, instead of 3.27, we write $3\frac{1}{3}$, this takes the approximate

form,
$$a = \frac{10 T^2}{10 T^2 + 3 h} \times \beta,$$

which will be sufficiently near for practical purposes.

Take one or two simple illustrative examples. For the

Prince Consort $T = 5\frac{1}{2}$ seconds; and h may be taken as 20 feet, if the pendulum were placed on the bridge.

$$\text{Then } \frac{a}{\beta} = \frac{10 T^2}{10 T^2 + 3h} = \frac{300}{300 + 60} = \frac{5}{6},$$

$$\text{or } a = \frac{5}{6} \beta;$$

and the pendulum increases the true angle of heel by no less than 20 per cent. In the *Devastation* a pendulum placed on the flying deck may be taken as 25 feet above water; also $T = 6\frac{3}{4}$ seconds.

$$\text{Then } \frac{a}{\beta} = \frac{10 \times (6\frac{3}{4})^2}{10 \times (6\frac{3}{4})^2 + 3 \times 25} = \frac{450}{450 + 75} = \frac{450}{525} = \frac{6}{7};$$

$$a = \frac{6}{7} \beta.$$

Here the pendulum indications exaggerate the true angles of inclination by about 16 per cent.; notwithstanding the greater height of the point of suspension above the centre of gravity, the slower motion of the *Devastation* makes the error smaller than in the *Prince Consort*.

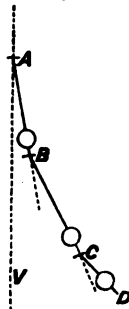
So much for the simple case of still-water oscillations. When we turn to the more complicated case of a ship oscillating amongst waves, there are good reasons for supposing that the errors of pendulum observations will be exaggerated. The centre of gravity of the ship is then, as explained in the preceding chapter, subjected to the action of horizontal and vertical accelerating forces. If the pendulum were hung at the centre of gravity (G) of the ship shown on a wave in Fig. 62, page 153, it would, therefore, no longer maintain a truly vertical position during the oscillations, but would assume at each instant a position determined by the resultant of the accelerating forces impressed upon it and of gravity. The direction of this resultant has been shown to coincide with that of the corresponding normal to the effective wave slope.* Hence

* See the remarks on page 151 and Fig. 60.

follows another useful practical rule. When a ship is rolling amongst waves, a quick-moving pendulum suspended at the height of the centre of gravity will place itself normal to the effective wave slope, and its indications will mark the successive inclinations of the masts of the ship to that normal, not their inclinations to the true vertical. This distinction is a very important one. For example, in an American monitor, supposing her to keep her deck very nearly parallel to the wave slope as she might do, if a pendulum were hung close to the height of the centre of gravity, it would indicate little or no rolling motion; whereas it has been shown that the monitor would really be reaching inclinations equal to the maximum wave slope on each side of the vertical.* On the other hand, if a steady ship, such as the *Inconstant*, were amongst the same waves, a pendulum hung at the centre of gravity would indicate extreme angles of inclination far in excess of the true rolling; for if the ship remained practically upright during the passage of the waves, the pendulum would indicate angles of inclination nearly equal to the effective wave slope.

When hung at any other height than at that of the centre of gravity of a ship rolling amongst waves, the indications of a pendulum are still less to be trusted. Referring to Fig. 73, three pendulums will be seen combined, viz. AB, to which hangs BC, and from this is suspended a third, CD. Supposing AB made to swing through a fixed range, it will represent the wave oscillation; then the motion of BC will represent the oscillations of a ship amongst the waves; and finally CD will represent the clinometer-pendulum suspended at some point other than at the height of the centre of gravity of the ship. In view of what has been said above, it will be obvious that

FIG 73.



the motions of the pendulum BC will not be indicated correctly by the pendulum CD ; yet this is exactly a parallel case to that when a pendulum or clinometer is trusted to indicate the angles of inclination to the vertical of a ship rolling amongst waves. Pendulum indications, under these circumstances, usually err in excess, and in some cases the error is proportionately very great, as the following examples will show. The figures are taken from published returns of rolling for her Majesty's ships.

Ships.	Pendulum Indications.	Correct Angles.
	Degrees.	Degrees.
<i>Lord Waraen</i>	11·4	9·1
<i>Minotaur</i>	6·1	3·8
"	8·2	4·3
<i>Bellerophon</i>	8·2	3

Many similar examples could be given, but they appear unnecessary; the correct angles stated in the table were observed in all cases with the accurate batten instruments which are now the service fitting.

The misleading character of pendulum observations has been for many years acknowledged ; and they are no longer made in ships of the Royal Navy, except in special cases. When the horizon is obscured, or at night, batten observations cannot be made, while pendulum observations can ; and it is ordered that under these circumstances the rolling indicated by the pendulums shall be noted. To enable the results so obtained to be afterwards corrected, simultaneous observations are made, when circumstances permit, of the indications of these same pendulums hung in the same positions, and of the indications of batten instruments.

In concluding these remarks on pendulum observations, it may be proper to add that any other devices, such as spirit-levels, depending for their action on the directive force of gravity or statical conditions, are affected by the motion of a ship much as the pendulum has been shown to be affected.

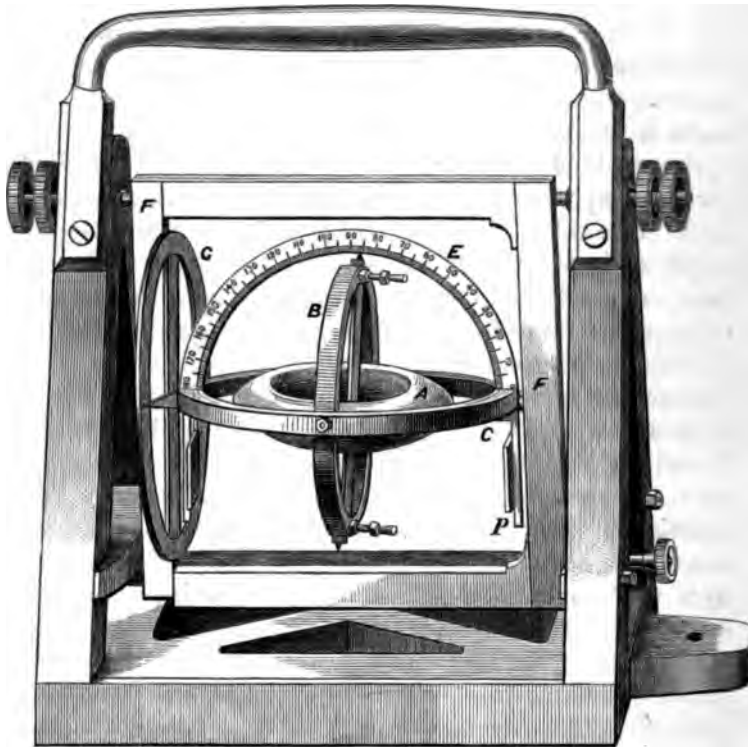
Suppose a spirit-level to be placed in the best possible position in a ship, at the height of the centre of gravity; in accordance with the principles previously explained, when its indications would lead an observer to think it exactly horizontal, it would really be parallel to the effective wave slope. Many persons who admit the faultiness of the pendulum are disposed to cling to the use of the level; but on reflection it will be seen that both instruments are open to similar objections. Moreover, the extreme sensitiveness and rapid motions of the spirit-level make it ill adapted for any observations in a seaway.

Several kinds of *gyroscopic instruments* have been devised for the purpose of measuring rolling and pitching motions, all of them being based upon the well-known principle—exemplified in the toy gyroscope—that a delicately balanced heavy-rimmed wheel spinning rapidly will maintain the plane of rotation in which it is set spinning, until its speed of rotation is considerably diminished. One of the earliest and best instruments of the kind is illustrated by Fig. 74. It was devised and tried at sea nearly twenty years ago by Professor Piazzi Smyth, Astronomer Royal of Scotland, and can be used to measure “yawing” motions as well as rolling and pitching.* It consists of a fly-wheel A, the axis of which forms a diameter of the gymbal-ring B; this is carried by a second gymbal-ring, C, the pivots of which rest on the frame F; and the whole is mounted in an outer frame, enabling it to be easily carried or placed in position. Suppose the pivots of the ring C to be placed athwartships in a ship, the instrument standing on the deck or on a table: then for transverse oscillations the line-of-centres of the pivots will remain parallel to the deck—that is to say, so far as rolling is concerned, the ring C must move with the ship. But it is free to oscillate about its pivots as the ship pitches.

* See the description given by Naval Architects, from which the the inventor in vol. iv. of the drawing is taken.
Transactions of the Institution of

When the fly-wheel A is spinning rapidly and maintaining its plane of rotation, it is practically uninfluenced by the motions of the ship which so largely affect the pendulum ; and as its axis is carried by the ring B, that ring also must

FIG. 74.



maintain its position. This maintenance of position by B further involves the non-performance of any oscillations by C except in the *transverse* sense. In other words, neither A nor B changes the direction of its plane, while the ship rolls and pitches, so long as A spins rapidly ; while C can accompany the rolling motion, but not the pitching

motion. Hence the graduated semicircle E, shown fixed upon and across C, moves relatively to B as the ship rolls; and the pointer attached to the upper edge of B sweeps over an arc on the semicircle equal to the arc through which the ship is oscillating. On the left-hand side of the diagram there is shown a graduated circle G, which has its centre coincident with one of the pivots of C, and is *fixed* to the frame F. As the ship pitches, therefore, the frame F moves with her, and oscillates about the ring C, which is prevented from accompanying the pitching in the manner described. Pointers marked *p* are attached to the under side of C, and the arcs they sweep over upon the graduated circle G indicate the arcs through which the ship pitches. By this ingenious arrangement the simultaneous rolling and pitching motions can be read off by observers with the greatest ease.

One point of disadvantage attaching to this as well as to all other gyroscopic instruments should, however, be noted; viz. that there is no separate indication of the angles of inclination attained on either side of the vertical. When the wheel A is set spinning, if it were truly horizontal, then B would be vertical, and this disadvantage would disappear. But a ship in a seaway changes its position rapidly, and it is practically impossible to secure this condition of initial horizontality; hence the observer must be content to note the *total arcs* of oscillation. No doubt, in most cases, the rolling of a ship not under sail approaches equal inclinations on either side of the vertical, the roll to leeward being somewhat in excess of that to windward; but in a ship under sail the rolling takes place about an inclined position, and in any case it is a great advantage to be able to ascertain the extreme inclination on either side of the vertical.

Professor Smyth fully appreciated this defect of all gyroscopic instruments, observing that they had "no power of determining absolute inclination, or angular position with reference to horizon or meridian;" but he was unacquainted with any other instrument which did not have its records

affected by the accelerating forces due to the motion of the ship, and so preferred the gyroscopic clinometer. Now we have other means of measurement free from the objections belonging to pendulums or spirit-levels, and can therefore afford to dispense with the gyroscope.

It has been mentioned that the maintenance of the plane of rotation by a fly-wheel depends upon the maintenance of its speed; this is well illustrated in the common toy, which droops as the speed decreases. The practical difficulties attending the use of these instruments arise, therefore, from the extreme care required in suspending the fly-wheels in order that friction or other causes may have the least effect in hindering free rotation, and in the difficulty of maintaining continuous rotation. The instrument shown in Fig. 74 is said to have been so well designed that, when once carefully adjusted, it did not require readjustment for some time; but from the few records of its use that have been published, it would appear that Professor Smyth limited any single series of observations to a very brief period. When a considerable time is occupied in making the observations, there is a danger of the gyroscopic action being somewhat interfered with by the loss of speed of rotation.*

On this point some interesting facts have been stated by Admiral Paris, of the French navy, who produced a gyroscopic clinometer ten years ago, which automatically recorded the rolling of a ship. The gyroscopic wheel in this instrument formed the body of a top, the lower end of the axis about which it spun being wrought to a sharp point, and resting on an agate bearing in order to diminish friction. To spin this top, a string was wound round the upper part of the axis, and drawn off gradually, giving a gradually accelerated motion of rotation. It was found that this top would revolve steadily

* It may be interesting to add that, when the instrument illustrated in Fig. 74 was used to measure "yawing," it was placed with the pivots of the ring C in a vertical

line; the frame lying on its side instead of its bottom, and the wheel B being horizontal. The angles of "yawing" could then be read off on the graduated circle G.

on a support for about half an hour ; but nine minutes sufficed to degrade its revolutions from 23 per second to 12 per second ; and this lower speed sufficed to make the top steady enough to be used for recording the motion of a ship in a seaway ; the observations were usually extended over about ten minutes.

The automatic recording apparatus was extremely simple. As the ship rolled, the gyroscopic top maintained its axis in the same direction as that in which it was set spinning, and upon the upper end of the axis a camel-hair pencil saturated with ink was fixed. A sheet of paper was made, by means of clockwork, to travel longitudinally over the pencil-point, being curved in the transverse sense, so that the point should just touch the paper as it swayed to and fro. The paper, with the arrangements by which it was made to travel, being attached to the ship, rolled with her, while the axis of the top maintained its original direction ; hence the pencil-point traced out on the paper a curve showing the inclinations of the ship at any instant on either side of the initial position of the pencil. The rate at which the clockwork propelled the sheet of paper being constant enabled the period of oscillation of the ship, as well as the arc of oscillation, to be read off from the diagram traced. Admiral Paris appears to have endeavoured to set the axis of his top truly vertical before commencing to record the motion, in order that the diagram might show inclinations to the vertical as well as arcs of oscillation ; but in doing this, he must have encountered considerable difficulties, even if he was successful. We cannot further describe his ingenious arrangements, but would refer readers to the full details given in vol. viii. of the *Transactions* of the Institution of Naval Architects.

M. Normand has proposed an instrument for measuring rolling differing from the gyroscope in principle, but intended to effect a similar object, viz. the maintenance of an invariable plane, to which the motions of the ship could be referred. A spherical vessel is entirely filled with petroleum, and hung on double gymbal-rings like a compass. It contains a very light pendulum, situated at the centre of the sphere, and

formed as a flat disc, carrying a pointer which stands at right angles to the disc. The inventor supposes that the fluid in the central parts of the sphere would have no angular motion set up in it by the reciprocating oscillations of the ship or the small oscillations of the sphere on its gymbal-rings, and that the pendulum would remain practically horizontal while the vessel rolled, its indicator being vertical. Much would obviously depend upon the position in the ship at which this instrument was placed. Supposing it to be at the centre of gravity, M. Normand's supposition might be nearly fulfilled, and the sphere with its contents would act like a common pendulum, its motions being governed by those of the effective wave slope, and keeping time with the wave period. Under these circumstances it is conceivable that the motions of the disc-pendulum might be small, and the motions of the ship might be fairly well indicated. But the use of any such instrument has never, we believe, found general favour; for general service simpler methods suffice, and for more scientific research it appears preferable to have recourse to a different principle, hereafter to be described, in order to secure the invariable vertical line of reference which M. Normand aimed at securing.*

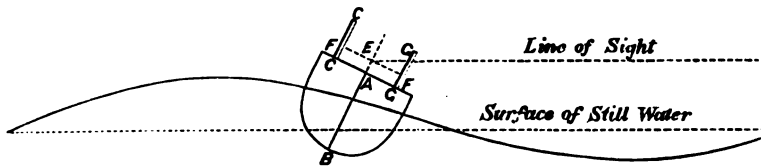
Batten instruments afford the simplest correct means of observing the oscillations of ships; they can be employed whenever the horizon can be sighted. The line of sight from the eye of an observer standing on the deck of a ship to the distant horizon will always remain practically horizontal during the motion of the ship. Consequently, if a certain position be chosen at which the eye of the observer will always be placed, and when the ship is upright and at rest, the horizontal line passing through that point is determined and marked in some way; this horizontal line can be used as a line of reference when the ship is rolling or pitching, and the angle it makes at any instant with the

* Drawings and descriptions of this instrument will be found in vol. vii. of the *Transactions* of the Institution of Naval Architects.

line of sight will indicate the inclination of her masts to the vertical.

This principle may be applied in different ways; one of the most common, generally adopted in the ships of the Royal Navy, is illustrated in Fig. 75. The point E on the middle line of the cross-section marks the position of the eye of the observer; and at equal distances athwartships, two battens CC and GG are fixed perpendicularly to the deck, so that, when the ship is upright and at rest, these battens are vertical, and at that time the line FEF will be horizontal. This line may be termed the "zero-line"; and the points F, F would be marked upon the battens, being at a height above the deck, exceeding that of the point E by an amount determined by the transverse curvature or "round" of the

FIG 75.



deck. Suppose the diagram to represent the case of a ship rolling among waves; when she has reached the extreme of an oscillation to starboard, EG marks the line of sight to the horizon, and the angle GEF measures the angle of inclination of the masts to the vertical. If the battens are placed longitudinally, instead of transversely, the angular extent of pitching may be similarly measured. The angles are usually read off on that side of the point of observation E towards which the vessel is inclined; rolls to starboard being measured, for example, on the starboard battens, rolls to port on the port battens. Sometimes the inclinations to both port and starboard are read off on one batten, above and below the zero. It is a great practical convenience to have the vertical battens graduated so that an observer can at once read off and note down the angles of

inclination in degrees. This graduation is very simply effected when the positions of the battens relatively to *E* have been fixed, and the zero-line *FEF* determined. Once graduated, the battens can, of course, be removed when the observations are not in progress, and replaced in the same positions when required.

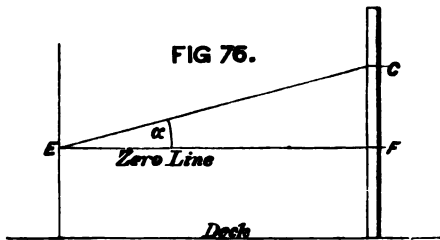
In graduating the vertical battens, the following table of tangents from 1 degree to 40 degrees of inclination may be of some service to officers undertaking the work :—

Angles.	Tangents.	Angles.	Tangents.
Degrees.		Degrees.	
1	0·017	21	0·384
2	0·035	22	0·404
3	0·052	23	0·424
4	0·07	24	0·445
5	0·087	25	0·466
6	0·105	26	0·488
7	0·123	27	0·51
8	0·141	28	0·532
9	0·158	29	0·554
10	0·176	30	0·577
11	0·194	31	0·601
12	0·213	32	0·625
13	0·231	33	0·649
14	0·249	34	0·675
15	0·268	35	0·7
16	0·287	36	0·727
17	0·306	37	0·754
18	0·325	38	0·781
19	0·344	39	0·81
20	0·364	40	0·839

The zero-line on the battens having been fixed in the manner previously explained, the horizontal distance from the position where the eye of the observer will be placed to the vertical batten is measured; suppose this to be *d* feet, it will be indicated by *EF* in Figs. 75 and 76. Then, for any angle *a*, we have,

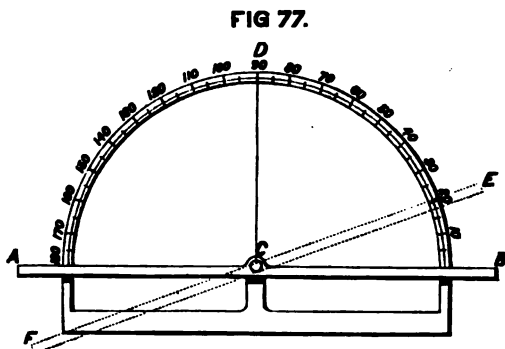
$$\left. \begin{array}{l} \text{Vertical height (FG) to be set off above} \\ \text{zero-line on batten} \end{array} \right\} = d \cdot \tan a.$$

The value of $\tan a$ being taken from the table, the product $d \tan a$ can be found. For instance, suppose $d = 20$ feet, and $a = 15$ degrees: $\tan a = 0.268$, and vertical distance (FG) to be set above zero-line will be $(20 \times 0.268) = 5.36$ feet. With this table and the example of its use, the very simple process of graduation can present no difficulty.



Another form of the batten instrument is shown in Fig.

77. AB is a straight-edged batten pivoted at C, and carried by a frame having attached to it a semi-circular graduated arc. Suppose that, when the ship is upright and at rest, the base of the instrument is so fixed that the pivoted bar, occupying the position AB, is horizontal.



Then the line ACB marks the zero-line to which angles of inclination may be referred. The instrument may, if desired, be set transversely when rolling motions are being observed; the observer looking along the edge of the pivoted batten will always keep it pointed to the horizon, and its motions can be observed on the graduated arc. For example, suppose the position FE to have been reached, then the angle FCB (a little over 20 degrees) will indicate the inclination of the masts of the ship to the vertical at that instant.

Instead of looking lengthwise, and athwartships, along the edge of the batten when the instrument is set transversely, the observer may, if he prefers, stand before or abaft the instrument, and move the pivoted bar so as to keep its edge always parallel to the horizon; the angular motion of the bar indicated on the graduated arc will measure the inclination as before. To measure pitching, the instrument should be set longitudinally in the ship, the zero-line being adjusted as explained for rolling; and the observer will either look longitudinally along the edge of the batten, in order to keep it pointed to the horizon, or will stand and look athwartships, keeping the edge parallel to the horizon. In either case the angles of pitching may be read off from the graduated arc.

It will at once occur to the reader that the angular motions of such a pivoted bar might be readily made, by means of suitable mechanism attached to some point on the bar, to furnish an automatic record on a travelling sheet of paper moved at an uniform speed by clockwork. This has actually been done in some cases, a diagram being automatically traced, showing the inclinations of the ship throughout the period of observation. Hereafter the character of such mechanism will be illustrated, so that further description here is not required.

The proper conduct of observations with common batten instruments requires at least two observers: one to note the extreme angles of inclination attained by the ship, a second to note the periods of successive rolls. In the Royal Navy a single series of observations would last ten minutes, and during that time one observer would have to note the extreme inclinations for from seventy to, perhaps, one hundred and fifty or two hundred single rolls, according to the class of ship and character of the waves.* The other observer would, meanwhile, note the times of performing successive rolls,

* To facilitate the entry of the particulars, printed forms are issued to the ships of the Royal Navy.

and the total number of rolls during the ten minutes. To complete the materials required for a discussion of the behaviour of the ship, the dimensions and periods of the waves ought to be observed simultaneously with the rolling or pitching; and this requires the attention of an independent set of observers, whose work should be conducted somewhat in the manner indicated in Chapter IV. In large war-vessels with numerous complements it is easy to carry on such observations; in small vessels it is not always easy to provide for the working of the ship and to detail officers for observations of rolling and pitching. The most important observations are, however, those made in large ships of new types.

For all ordinary purposes batten observations of rolling and pitching, such as are made in the Royal Navy, suffice; but they require the simultaneous attention of at least two observers, and depend for their accuracy upon the care exercised by these gentlemen. Moreover, they simply furnish the extreme inclinations attained by the ship, and the period of her oscillation; and although these may be associated with simultaneous observations of the waves, there is no continuous record of the ratio of the angle of inclination of the ship to the angle of wave slope. More complete information, such as is most valuable for scientific purposes, can be best secured by means of automatic instruments, the records of which may be made continuously during prolonged periods. Such instruments require care both in their construction and management; but if they are based upon correct principles, they can be, and have been, made capable of far surpassing the results obtained by the most careful personal observation. Both in France and in this country such instruments have been made and used. M. Bertin, of Cherbourg, and Mr. W. Froude independently constructed instruments for this purpose, based upon very similar principles. That of Mr. Froude has been used on board the *Greyhound*, *Perseus*, and *Devastation* with great success, and a description of its leading features will be welcomed

by all who take an interest in the subject of the behaviour of ships at sea, and may not have had the opportunity of consulting the descriptions which Mr. Froude has published.*

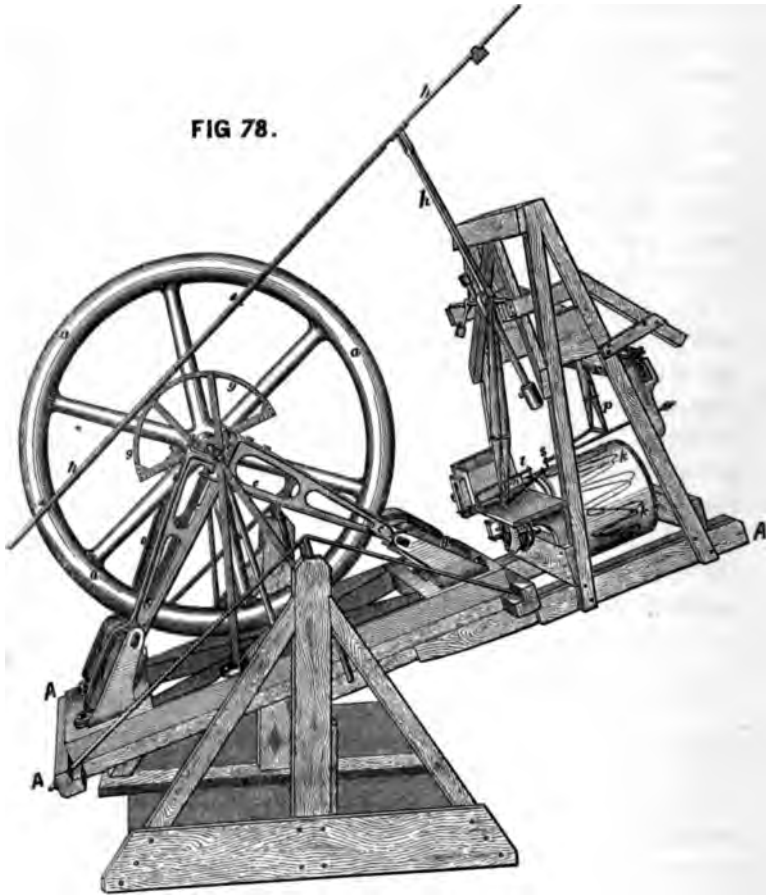


Fig. 78 contains a general view of the instrument, mounted on a rocking platform, AAA, the motions of

* For these see vol. xiv. of *Transactions* of the Institution of Naval Architects; from which most

of the particulars given in the text and the drawing of the instrument are taken.

which represent those of the deck of a ship rolling in a seaway. The surface of the rocking platform to which the instrument is secured is shown at a considerable inclination, and the fixed frame upon which it rocks will be readily distinguished.

Two fundamental principles, already explained, may be again mentioned in order to facilitate explanation: (1) if a pendulum of very short period is hung at the height of the centre of gravity of a ship rolling among waves, it will at each instant stand practically normal to the effective wave slope; (2) if a pendulum of very long period be hung in the ship, it will remain practically vertical while she rolls. In the instrument there are two such pendulums; when the ship is upright and at rest, they both occupy a vertical position which is marked on some part of the apparatus that accompanies the motion of the ship. When the ship rolls, the oscillations of the quick-moving pendulum indicate the angles of inclination, at every instant, of the masts of the ship to the normal to the effective wave slope; while the oscillations of the very slow-moving pendulum indicate the simultaneous inclination of the masts to the vertical. From these two records the angles of wave slope at various times can be deduced, being the algebraical difference of the pendulum inclinations; and the profile of the effective wave surface can be constructed. In short, every important feature in the behaviour of the ship is brought within the scope of analysis, by means of the diagrams automatically traced by the instrument.

The quick-moving pendulum is shown in Fig. 78 by r (on the right side of the drawing, and about mid-height on it). It consists of a horizontal brass tube, filled with lead so as to form a heavy bar-pendulum; this is suspended at each end on knife-edges, situated near the upper part of the circumference of the bar. The bar is only $2\frac{1}{2}$ inches in diameter, and about 20 inches long; so that the arrangement really produces a powerful and sensitive pendulum, of less than 2 inches in length, and consequently having a very

short period.* It carries an arrangement of light arms (p), at the end of which is a pen, s ; and as the bar-pendulum swings to and fro, the pen s registers the motion upon a sheet of paper carried by the cylinder k , which is driven by clockwork. The pen s traces on the paper a continuous line, and as the cylinder k revolves, another piece of clockwork l marks upon the paper a "scale of time": so that the diagram produced shows not merely the successive inclinations of the ship to the effective surface, but also indicates the times at which those inclinations are attained. The interval of time marked by this scale, between two consecutive extremes of inclination, will show the "period" of the corresponding oscillation.

Considerable practical difficulties had to be overcome in constructing the second pendulum, which has a very long period. It consists of a heavy-rimmed wheel (a , in Fig. 78), 3 feet in diameter, weighing 200 lbs.; this is carried on an axis of steel, 1 inch in diameter, the centre of gravity of the whole being only six-thousandths (0.006) of an inch away from the centre of the axle. Here we see an arrangement identical in character with a ship having very little initial stability, but great inertia; the two contributing to produce a very long period. The observed time for a single swing of this wheel-pendulum, as it may be termed, has been found to be about 34 seconds; the magnitude of this period becomes evident when it is remembered that the slowest-moving ships have periods for a single roll of about 9 seconds only, and that the half-period of the largest waves commonly met with are still less. Friction rollers (c, c) support the steel axle; and the extreme delicacy of the suspension of this heavy wheel is attested, says Mr. Froude, "by the fact, that, when at rest, a breath on the "circumference (of the wheel) will move it perceptibly." This wheel-pendulum continues almost unmoved as the

* A pendulum having a length of 2 inches has a period for a single roll of about two-tenths of a second only.

ship rolls. The effects of any very small motion which the wheel may acquire are easily eliminated, and it practically indicates at every instant the true vertical direction, as well as the inclination thereto of the masts. This wheel is also made to record its motions on the revolving cylinder *k*. A wooden semi-circle *g* is carried on the axis, and by means of the light rods *h*, *h* — which are carefully counterbalanced — the relative angular motions of the ship and the steady wheel are made to move a pen, *m*, which draws a curve on the paper stretched upon the cylinder *k*. The character of this curve is similar to that traced by the pen *s*, moved by the pendulum *r*; and both these curves are indicated by the curved lines shown on the cylinder *k*, the rotary motion of the cylinder and the motion of the pens parallel to its axis combining to produce this result. The time scale is the same for both curves; and on that traced by the pen *m* the time interval between any two consecutive extremes of inclination measures the corresponding period of oscillation of the ship. When the observations are over, the paper can be removed from the cylinder *k*, and the diagrams drawn by the automatic apparatus can be analysed. Into this part of the work, however, it is unnecessary now to enter, our purpose being to give only a general sketch of the instrument. It furnishes the following information:—

(1) The relative inclination of the ship and the effective wave slope at any instant.

(2) The inclination of the ship to the vertical at any instant.

(3) The period of oscillation of the ship at any time—that is, the number of seconds occupied in completing the roll from port to starboard, or *vice versa*.

From 1 and 2 may also be deduced:—

(4) The angle of slope of the effective wave surface at any instant.

(5) The period of this effective wave, which will agree with the *apparent period* of the surface waves.

If, therefore, careful observations are made, while the instrument is at work, of the dimensions and periods of waves, the comparison between the observed slope of the surface wave and the deduced slope of the effective wave will furnish a test of the correctness of the ordinary assumption as to the effective wave slope. It will also enable future estimates of the probable rolling of ships to be made more precise than is now possible, owing to the doubts surrounding this question of the effective wave surface.*

Before concluding this chapter, it may be well to repeat that, whatever method of observing the rolling or pitching may be adopted, the observations made cannot have their full value unless the attendant circumstances are fully recorded. For example, the *actual condition of the ship* at the time should be noted; whether she is under sail or steam; what portion of her consumable stores remain on board; whether the boilers are full or empty; whether there is anything unusual in her stowage; whether there is any water in the bilges; and any other features that would affect the still-water period of oscillation. Her *course* and *speed* should also be stated, the former being given relatively to the line of the wave advance, and the angle between the two being stated in degrees where possible. The dimensions and periods of the waves, both real and apparent, should also be carefully determined, as explained in Chapter V. Moreover, no change should be made affecting the behaviour of a ship for some time before the observations are commenced, nor during their progress; a change of course, an alteration in the sail spread, a change of speed, or any other changes, made immediately

* Independently of the use of this instrument, naval officers might do much to add to existing knowledge on this point if they associated ordinary batten observations with simultaneous observations of the angles indicated by short pendulums

hung at the height of the centre of gravity of the ship. Great care would be required to ensure the simultaneity of the records of battens and pendulums if this plan were adopted.

before the observations began, might seriously influence the behaviour during the comparatively short time over which a series of observations extends; and it is needless to point out the necessity for avoiding any changes during that short time. The Admiralty instructions enforce these conditions, providing that no change of course or speed, or spread of sail, &c., shall be made for at least ten minutes before the observations are commenced.

The most perfect sets of observations of the behaviour of a ship yet made were those conducted by Mr. Froude, on behalf of the Admiralty, on board the *Devastation*. But unfortunately for the scientific interest of the case, the weather encountered during the passage of that ship to the Mediterranean in 1875 was so moderate as neither to severely test her qualities nor to afford good opportunities for showing the full capabilities of the automatic instrument. Every naval officer proposing to enter upon similar work may read with advantage the brief report drawn up by Mr. Froude on the observations made during the passage.*

Ordinary observers have not similar advantages, but with the aid of the appliances in common use much valuable information has already been furnished by the Royal Navy, and it is to this quarter we must look chiefly for still further facts bearing on the behaviour of ships at sea. An intelligent acquaintance with the main deductions from modern theory, as well as with the moot points of the subject, will enable the observer to supply much more valuable information, seeing that he will be capable of distinguishing the more important from the less important conditions, and of giving a practical direction to his inquiries.

* Published as *Parliamentary Paper* No. 104 of 1876.

CHAPTER VIII.

THE STRAINS EXPERIENCED BY SHIPS.

THE structure of a ship floating at rest in still water is usually subjected to various straining forces tending to produce changes of form; and when she is rolling and pitching in a seaway, or propelled by sails or steam-power, her structure is still more severely strained. In order to provide the necessary structural strength to resist these straining forces, the naval architect has to make choice of the materials best adapted for shipbuilding, and further to distribute and combine these materials so as most efficiently to resist changes of form or rupture of any part. By these means he seeks to secure the association of lightness with strength to the fullest possible extent, an object of which the importance has already been illustrated.* Before it can be accomplished satisfactorily, the designer of a ship must have an intelligent appreciation of the causes and character of the strains to be provided against; otherwise materials may be concentrated where strength is not chiefly required, or *vice versa*. The importance of such knowledge has been recognised from the time when the construction of ships began to receive scientific treatment, but in this, as in most other branches of the subject, the greatest progress has been made within comparatively recent times. We now propose attempting a brief popular sketch of the chief straining actions to which ships are subjected, and in a

* See Chapter I. p. 3.

subsequent chapter will discuss the principles of the structural strength of ships.

The chief strains to which ships are subjected may be classified as follows:—

- (1) Strains tending to produce longitudinal bending—“hogging” or “sagging”—in the structure considered as a whole.
- (2) Strains tending to alter the transverse form of a ship; i.e. to change the form of athwartship sections.
- (3) Strains incidental to propulsion by steam or sails.
- (4) Strains affecting particular parts of a ship—“local strains”—tending to produce local damage or change of form, independently of changes in the structure considered as a whole.

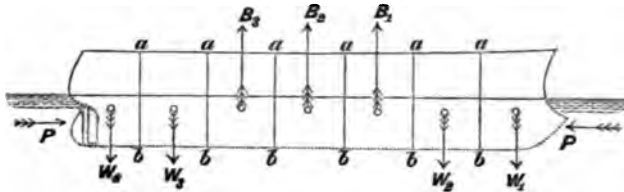
Besides these there are other strains, of less practical importance, which are interesting from a scientific point of view, but need not now be discussed, as there is ample strength in the structure of all ships to resist them, and there is no necessity in arranging the various parts to make special provision against such strains. Vertical *shearing forces*, for example, are in action in all ships; they tend to shear off the part of a ship lying before any cross-section from that abaft it; but no such separation of parts has been known to take place, nor is it likely to be accomplished in ordinary ships.

The order indicated in this classification is that which will be followed in our description, being the order of relative importance of the straining actions. All of them require consideration, but while it is not difficult to provide against the last two classes, it is important to bestow careful attention on the prevention of changes of transverse form, and it is still more difficult to prevent longitudinal bending.

In passing, it may be well to remark that a distinction must be made between the *tendency* of any strain and its observed effect upon the structure of a ship. No visible change of form may result from the action of very severe strains, because the visible result of that action depends

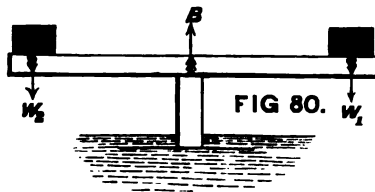
upon the strength and rigidity of the structure relatively to the strains brought upon it; nevertheless, the tendency of the straining forces is the same as if actual change of form was produced. For instance, it is very common to find wood ships "hogging" or "sagging" under the action of longitudinal bending strains; but iron ships, equally strained, have strength and rigidity so much in excess of wooden ships as to remain practically unchanged in form. Again, wood ships frequently "work," altering form transversely, when rolling in a seaway; and forces of equal intensity acting upon a stronger iron ship may give no external evidence of their existence. Yet in both cases the tendency of the straining forces is the same. This simple distinction is sometimes overlooked, and the absence of straining forces inferred from the maintenance of form.

FIG 79.



Turning to the principal strains requiring consideration—those tending to produce longitudinal bending—the case to be first considered is that of a ship floating at rest in still water. It has already been shown that there are two essential conditions of equilibrium: the ship must displace a quantity of water having a weight equal to her own weight, and her centre of gravity must be in the same vertical line with the centre of buoyancy. These two conditions may be fulfilled, however, and yet the weight and buoyancy may be very *unequally distributed*; the result being the production of longitudinal bending strains. As a very simple illustration, take Fig. 79, representing a ship floating at rest in still water. Supposing her to be divided by a number of transverse vertical planes (*ab, ab, &c.*), let each

piece of the ship between two consecutive planes of division be considered separately. At the bow there will probably be one or two portions for which the weight exceeds the buoyancy; these excesses of weight are indicated by W_1 and W_2 . Amidships the fuller form of the ship gives greater buoyancy to those subdivisions, and it is very common to find the buoyancy exceeding the weight, as indicated by B_1, B_2, B_3 , in the diagram. At the stern also the weight is likely to be in excess, as shown by W_3 and W_4 . The sum of these excesses of buoyancy will evidently balance the sum of the excesses of weight at the extremities; and the second hydrostatical condition of equilibrium requires that the resultant moment of these two sets of forces about any point shall be zero. It will be seen that a ship thus circumstanced is in a condition similar to that of the beam in Fig. 80, which is supported at the middle, and loaded at each

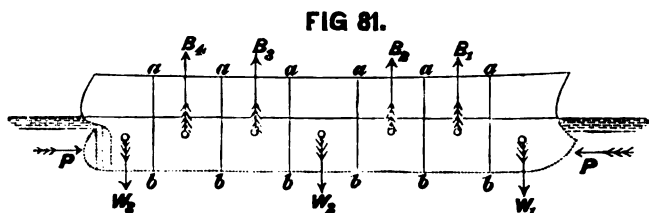


end. Such a beam tends to become curved, the ends dropping relatively to the middle, and the ends of the ship tend to drop similarly, the change of form being termed "hogging." Hogging strains are very commonly experienced at every part of the length of ships floating in still water.

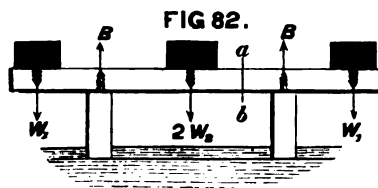
If the conditions of Fig. 79 were reversed, the excesses of buoyancy occurring at the extremities, and those of weight amidships, the ship would resemble a beam supported at the ends and loaded at the middle of the length. The middle would then tend to drop relatively to the ends, a change of form sometimes occurring in ships, and known as "sagging." It is to be observed, however, that in all, or nearly all, ships, when floating in still water, the fine form of the extremities under water makes the buoyancy of those parts less than the corresponding weights; so that sagging strains are rarely experienced throughout the whole length of a ship in still water. Among waves, as will be seen

hereafter, the conditions may be changed so as to produce sagging strains at every part of the length of a ship.

It is not uncommon to find the opinion expressed that, whenever there is an excess of weight amidships in a ship, sagging strains will be developed; but this is not a necessity. Suppose, for example, that Fig. 81 represents a vessel having



excesses of weight (W_2) amidships as well as at the extremities, and excesses of buoyancy at the intermediate portions. This is the condition of very many ships, such as paddle-steamers with their machinery concentrated in a comparatively small length amidships, or in ironclads with central armoured breastworks or batteries overlying the spaces occupied by the machinery. Such a vessel may be



compared to the beam in Fig. 82, supported at two points, and laden at the middle and ends. According to the view mentioned above, sagging strains should then be

produced under the middle-load; but it is easy to show that this may or may not be the case. For this purpose a short explanation is needed of a few simple principles, the application of which is general to ships as well as to beams.

Suppose it is desired to obtain the "bending moment" at any section—say ab —of the beam in Fig. 82. Conceive the beam to be rigidly held at that section, and reckoning from either end of the beam up to ab , let an account be taken of every force acting upon it, load and support, as well

as of the distance of the line of action of each force from the selected section *ab*. Multiply each force by the corresponding distance, add up separately the moments of the loads and supporting forces, and the differences of the two sums will be the bending moment required. It is immaterial which end is reckoned from in estimating the bending moment. As a very simple case, suppose it to be desired to find the bending moment of the forces acting upon the middle section of the beam in Fig. 82. Let the weight of the beam be neglected, and the supports be midway between the middle of the length and either end. Suppose the following values to be known:—

$4l$ = length of beam ; W_1 = load on either end ; $2W_2$ = load in middle.

Then each support will sustain a pressure (B) equal to $W_1 + W_2$. For the bending moment at the middle of the beam, we must have,

$$\text{Bending moment} = W_1 \times 2l - (W_1 + W_2) l = (W_1 - W_2) l.$$

Hence it will be seen that the following conditions hold:—

(a) If W_1 is greater than W_2 , there will be a *hogging* moment at the middle of the beam, and no section will be subjected to sagging moment, notwithstanding that the middle load $2W_2$ is carried.

(b) If W_1 is less than W_2 , there will be a sagging moment at the middle of the beam.

(c) Even in this second case the sections of the beam situated between the ends and the supports will be subjected to hogging moments, and so also will some part of the beam lying between the supports and the middle.

The case of the ship is similar, but more complex, the estimate of the bending moment experienced by the midship section involving the consideration of many vertical forces, some acting upwards and others downwards. But the foregoing is an illustration of the general mode of procedure,

and the conditions of the existence or non-existence of sagging strains amidships stated for the beam are paralleled by somewhat similar conditions for the ship. Reckoning from the bow or stern of a ship to the midship section, or to any other cross-section, it is easy to determine the bending moment when the relative distribution of the weight and buoyancy for that vessel has been determined. But in such a determination lies the difficulty of practically applying the principles just explained.

The longitudinal distribution of the buoyancy of a ship is readily ascertainable from the calculations ordinarily made for her displacement; but the corresponding distribution of the weight can only be found by means of a laborious calculation. Until quite recently very little exact information on this subject was accessible; but the work since done at the Admiralty for various typical war-ships, and at Lloyd's Registry for various classes of merchant ships, has added much valuable information, and enabled a more complete theory to be framed as to the conditions of strain to which ships are subjected.*

It is usual to represent the distribution of the weight and buoyancy of a ship by curves, similar to those shown in Fig. 83. A base-line (AB) is taken to represent the length of the ship, and at intervals of some 20 feet ordinates are drawn to

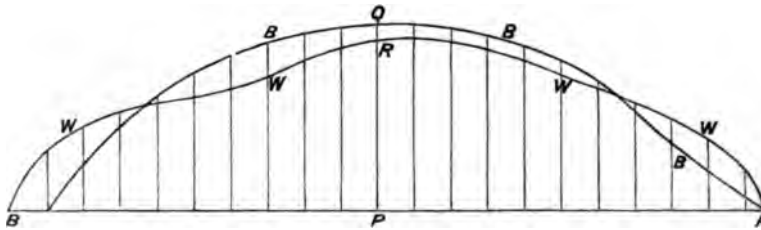
* These calculations for war-ships were commenced under the direction of Mr. Reed, C.B., F.R.S., M.P., when Chief Constructor of the Navy, and have since been extensively made. The principal results of Mr. Reed's calculations, together with many generalisations therefrom, were published by him in part ii. of the *Philosophical Transactions of the Royal Society* for 1871. The Author had the honour of assisting Mr. Reed in the preparation of this memoir, and the calculations upon which it was

based; many of the facts stated in the text are drawn from the memoir. As to the strains of merchant ships, see a valuable paper in the *Transactions of the Institution of Naval Architects* for 1874, by Mr. W. John, F.R.S.N.A., who assisted Mr. Reed in the earlier calculations made at the Admiralty. By the kind permission of Mr. Barnaby, C.B., Director of Naval Construction, particulars hitherto unpublished are given of the strains of the *Despatch* class in the Royal Navy.

represent the hypothetical planes of division above described. Midway between any two ordinates a line is drawn perpendicular to the base-line, and upon this is set off a length representing, on a certain scale, the buoyancy of the 20-foot length in the ship lying between the corresponding planes of division. A succession of points is thus obtained, and through these the "curve of buoyancy" (BBB) is drawn. The ordinary calculations for displacement afford a ready means of constructing this curve accurately.

To construct the curve of weight (WWW) is a matter of much greater difficulty. For each 20-foot length in the ship lying between two planes of division it is necessary to calculate the weight of hull and lading in detail; when this is found, it is set off on the line drawn midway between the

FIG 83.



ordinates corresponding to the two planes of division, the scale for weight being the same as that previously chosen for buoyancy. When a series of points has been determined, and the curve of weight drawn, its total area must equal that of the curve of buoyancy, and the centres of gravity of the two areas must lie on the same ordinate; these conditions are only another form of statement for the two essential conditions of equilibrium for the ship floating at rest. Taking any ordinate (say PQ), the intercept (QR) between the two curves represents the excess (or defect) of buoyancy at that place. Where the curve of buoyancy lies outside the curve of weight (reckoning from the base-line AB), buoyancy is in excess; where the curve of weight lies outside, the weight is in excess; at the sections where the curves cross,

the weight and buoyancy are equal, and these are termed "water-borne" sections. A more convenient mode of representing these excesses or defects of buoyancy is furnished in Fig. 84. Here the base-line and the dotted ordinates correspond to those in Fig. 83; and on any ordinate of those curves the intercept (say QR) is measured and transferred to the corresponding ordinate QR in Fig. 84, being set above the base-line AB when the buoyancy is in excess, and below when the weight is in excess. The curve LLL drawn through the points thus determined is termed the "curve of loads," and indicates, at a glance, the unequal distribution of the weight and buoyancy.

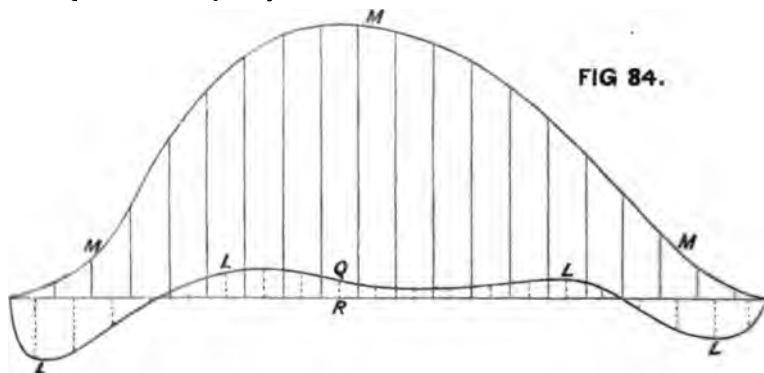


FIG 84.

The diagrams in Figs. 83 and 84 represent the case of her Majesty's ship *Minotaur* (armour-plated frigate, 400 feet in length), and are taken from the memoir of Mr. Reed previously referred to. She is a vessel completely protected by armour throughout her length from the upper deck down to some 6 feet under water; the finely formed ends are thus burdened with an excess of weight, the actual distribution of the weight and buoyancy being as follows:—

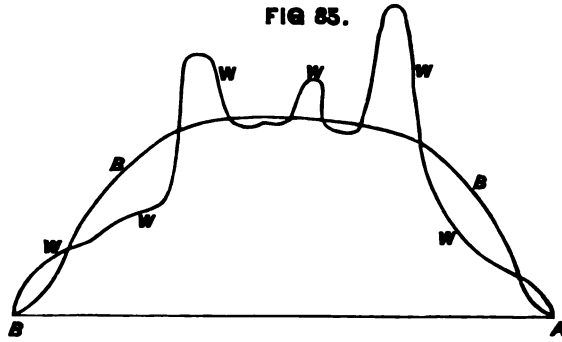
First 80 feet from the bow . . .	Weight	420 tons in excess.
„ 70 „ „ stern . . .	„	450 „ „
250 feet amidships. . . .	Buoyancy	870 „ „

This vessel in still water furnishes, therefore, an example of

the condition of the beam in Fig. 80. Hogging moments are experienced by all athwartship sections throughout the length, the maximum moment, at the midship section, being equal to the product of the total weight of the ship by $\frac{1}{88}$ of her length. The curve MMM in Fig. 84 indicates the variation in the bending moments from end to end of the ship; the length of any ordinate measuring the bending moment experienced by the corresponding cross-section in the ship. From the foregoing remarks the reader will have no difficulty in understanding how this curve of moments can be very easily constructed when the curve of loads has been drawn.

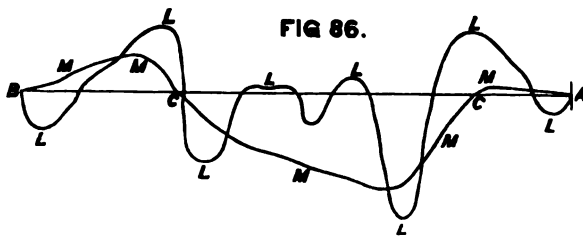
This is a very common case of the distribution of weight and buoyancy in ships; including the older types of sailing ships and many steam-ships. The excesses of weight at the extremities are, however, proportionately greater in an armoured vessel like the *Minotaur* than they are likely to be in unarmoured ships, and this exaggerates the maximum bending moment experienced by the midship section. It lies outside our present purpose to attempt any exhaustive statement of the varying conditions of weight and buoyancy either in ships of different classes or in the same ship when the weights are differently distributed. Attention must, however, be drawn to the facts, obvious enough from the preceding remarks, that the magnitude of bending strains in still water does not necessarily increase with deeper lading, and that for a given water-line and total displacement differences of stowage will greatly influence the strains. For example, if the armour were taken off the bow and stern of the *Minotaur* and stowed amidships, the excesses of weight at the extremities and of buoyancy amidships would be greatly reduced, causing a great reduction in the hogging moments at the midship section and elsewhere. On the other hand, if the *Minotaur* floats light, with engines, boilers, and all equipment removed as for a general repair, the excesses of weight over buoyancy at the extremities and of buoyancy over weight amidships become much greater than they are in the fully laden con-

dition. Instead of an excess of weight forward of 420 tons, there is, when light, an excess of 560 tons; while aft the excess increases from 450 to 500 tons; and amidships, on a length of some 230 feet, when the ship floats light, there is an excess of buoyancy of 1060 tons, as against 870 tons in the fully laden condition. The vessel is therefore subjected to much severer hogging strains when floating light in still water than she is when fully equipped. This is by no means an exceptional condition, and it explains the well-known fact that wood vessels often hog most soon after they are launched, or when lightened for thorough repairs.



In the *Devastation* class of the Royal Navy, a far less simple distribution of the weight and buoyancy is found than that occurring in the *Minotaur* type. Figs. 85 and 86 illustrate this case. The spur-bow and full form forward, as well as the absence of high armoured ends in the *Devastation*, make the excess of weight very small, as compared with the *Minotaur*—about 60 tons excess only on the first 20 feet of length. Then follows about 57 feet of length, before the central breastwork, where buoyancy is in excess by about 520 tons; this is succeeded by a great excess of weight—550 tons on 32 feet of length—under the foremost turret. Along the central part of the ship, where the armoured breastwork is situated, and the machinery and boilers are placed, there is very nearly a balance of weight and buoyancy, the difference not amounting to more than

10 tons on a length of 75 feet, although, as shown by the diagrams, there are two small excesses of buoyancy and one small excess of weight, the latter being due to the pilot-tower. Under the after turret, another large excess of weight occurs—320 tons on 38 feet of length; followed by a still larger excess of buoyancy—570 tons on a length of 63 feet; thence to the stern there is an excess of weight of 170 tons, owing to the fineness of the form of the ship in the run. These variations are indicated by the curves of weight (WWW) and buoyancy (BBB) in Fig. 85; but are more clearly shown by the curve of loads (LLL) in Fig. 86. The resultant bending moments are shown by the curve MMM, and offer a remarkable contrast to those for the *Minotaur*



(see MMM, Fig. 84). For the first 50 feet from the bow there is scarcely any bending moment to be resisted in the *Devastation*; whereas in the *Minotaur* the moment at the corresponding part amounts to about 8000 foot-tons. At the after part also the hogging strains in the *Devastation* are very small, the greatest hogging moment being less than one-seventh as great as that in the *Minotaur*. But the most marked contrast is found amidships; the concentration of weight in the turrets of the *Devastation*, the absence of great excesses of weight at the ends, and the altered distribution of the excesses of buoyancy, develop sagging moments, indicated in Fig. 86 by the ordinates of the curve MMM being drawn *below* the base-line AB. The maximum bending strains are also made much more moderate. The maximum sagging strain in the *Devastation* is only a little over one-third the maximum hogging moment in the *Minotaur*;

the exact figures are 15,300 foot-tons for the *Devastation* and 45,000 foot-tons for the *Minotaur*. Part of this reduction in bending moment is undoubtedly due to the less length and weight of the *Devastation*; but expressing the maximum bending moment as a fraction of the product of the length by the displacement—which is the fairest method—it is about $\frac{1}{10}$ for the *Devastation* against $\frac{1}{8}$ for the *Minotaur*.

When the excesses of weight and buoyancy are differently distributed in a ship having an excess of weight amidships, her condition may be intermediate between the two extremes already illustrated. The *Vanguard* is an example of this intermediate class. When fully laden, there is an excess of weight of 115 tons on the first 35 feet from the bow, then an excess of buoyancy of 220 tons on a length of 65 feet; amidships, under the double-storied central battery, there is an excess of weight of 275 tons on a length of 80 feet; next an excess of buoyancy of 380 tons on a length of 70 feet, and on the last 30 feet of length to the stern an excess of weight of 210 tons. The result of this distribution of weight and buoyancy is to develop maximum hogging moments in the fore and after bodies, corresponding to those experienced by the *Devastation*; but at the midship section, instead of a sagging moment, there is a *minimum* value of the hogging moment, about one-third as great as the maximum bending moment experienced by the after body.*

Summing up these remarks on the longitudinal bending strains produced by the unequal distribution of weight and buoyancy in ships floating at rest in still water, it will be seen that very considerable bending moments may be developed, the distribution of the weights very greatly affecting the amounts and character of the bending moments. Moreover, it is not always correct to say that the midship section sustains the greatest strain, cases occurring where there is

* The *Bellerophon* furnishes a similar case, and the reader desirous of fuller information cannot do better than consult Mr. Reed's

Royal Society paper, which has been published also in *Naval Science*.

a large excess of weight amidships, and yet the contrary is true—very little strain being brought upon the midship section, and the greatest strain being experienced by some section in the fore or after body. These still-water strains are not nearly so severe as those experienced by a ship at sea; but they are, on the other hand, of constant occurrence, and may be termed the “permanent” strains on the structure. Hence considerable interest attaches to an investigation of their values, and there is the further advantage that the investigation leads up to the more important case of straining in a seaway.

Besides these vertical forces, a ship floating in still water has to resist longitudinal fluid pressures, tending to compress the lower part of the structure, and to produce longitudinal bending. Euler, and some of the other early writers on the subject, mentioned this fact, but they erred in their methods of estimating the effect of these pressures. In Figs. 79 and 81, P, P indicate the pressures, which balance one another when the ship is at rest; their bending moment may be stated approximately as equal to the product of P into the distance of the “centre of pressure” of the immersed midship section below the middle of the depth of that section, reckoning that depth from the upper deck to the keel.* This moment is never absolutely great, but it sometimes assumes relative importance, especially in vessels with concentrated weights amidships. For example, Mr. Reed states that in the central-battery ironclad *Bellerophon*, the vertical forces develop a very small bending moment, whereas the longitudinal fluid pressures produce a moment of over 3000 foot-tons—about *one-fourth* of the maximum hogging moment experienced by any cross-section of the ship when floating in still water. In the *Vanguard* class, a nearly identical ratio holds between the moment due to the horizontal fluid pressures and the maximum hogging moment, which is

* More exactly, the distance of the centre of pressure should be reckoned from a point a little above the centre of gravity of the sectional area of the parts on the midship section contributing resistance to bending.

experienced by a section in the after body, in consequence of the unequal distribution of weight and buoyancy previously particularised. This branch of the subject is, however, interesting rather than practically important, because the naval architect has little or no power to modify the amount or effect of the longitudinal pressures; whereas in the distribution of the weights of cargo, armour, armament, or equipment along the length of a ship he can often exercise considerable influence.

Passing from the longitudinal bending strains experienced by ships in still water to those experienced when ships are at sea, it is evident that the latter strains must be far more severe and distressing to the structure. This arises principally from three causes. First, the existence of waves and the departures of the wave profiles from the level of still water will produce exaggerations in the inequality of distribution of the weight and buoyancy. Second, the rapid transit of waves past a ship will produce continual variations in the distribution of the buoyancy, these being necessarily accompanied by great and rapid changes in the character and intensity of the bending moments brought upon the structure. Third, the establishment of pitching and 'scending movements in the ship, as well as of vertical heaving motions, will lead to the development of accelerating forces tending to increase the strain upon the structure. It will, of course, be understood that we are still dealing with the longitudinal bending of the ship considered *as a whole*, and not with local strains such as may be produced by blows of the sea.

These general considerations are certain to command acceptance, but when an attempt is made to give them a more exact application, in order to determine the probable maximum strain which may be brought upon a ship exposed to the action of waves, difficulties arise of a very serious character. In fact, the best authorities agree in adopting a mode of treatment which has much to recommend it, although it by no means comprehends all the conditions of the problem, being rather a means of comparing the strains

of different ships than of estimating the absolute maximum strain likely to be brought upon a particular vessel in a seaway. Two extreme cases are taken: one (illustrated by Fig. 87) where the ship is supposed to rest instantaneously in statical equilibrium upon the crest of a wave having a length equal to her own; the other (see Fig. 88) where, in instantaneous equilibrium, she lies across the hollow of the

FIG 87.



same wave, her bow and stern being at successive crests. The waves are assumed to have the maximum steepness likely to be associated with their length; the ship is supposed to displace as much water on the waves as in still water; her centre of gravity is supposed to be exactly over the centre of buoyancy corresponding to each of the extreme positions; and, instantaneously, she is treated just as if the wave delivered its pressure upon her vertically, much as

FIG 88.



still water does, the *form* of the displacement only being changed. Objections may, of course, be urged to all these assumptions; but, on the whole, they appear to embody the best method of comparing the severest longitudinal bending strains of different classes of ships.

A glance at the diagrams shows how great a difference in the distribution of the buoyancy is produced by the passage of the wave; WL in each indicates the load water-line in still water. On the crest (see Fig. 87) the buoyancy at the extremities of the ship is decreased as compared with still

water; the buoyancy amidships being considerably increased. In the hollow (see Fig. 88) the conditions are reversed; there is an increase of buoyancy at the bow and stern which sink into the wave deeper than the level of WL; while there is a decrease of buoyancy amidships. Speaking generally, it may be said, therefore, that all classes of ships supported on the crest of a wave of their own length tend to *hog throughout their length*, the greatest hogging moment being experienced either by the midship section or a section lying near to it. This is true even for vessels with central weights like the *Devastation* or the *Vanguard*. On the other hand, in all except very few and unusual cases ships astride a wave hollow (as in Fig. 88) have excesses of buoyancy at the ends and excesses of weight amidships; consequently they are subjected to *sagging moments throughout the length*,* the maximum bending moment being experienced at or near the midship section, even by ships like the *Minotaur*, which in still water tend to hog throughout the length.

A few facts for the *Minotaur* and *Devastation* will more clearly illustrate the foregoing statement. When the *Minotaur* floats on the crest of a wave 400 feet long and 25 feet high, the excesses of weight at the bow and stern become increased to 1275 and 1365 tons respectively—about *three times* as great as the corresponding excesses in still water; the excess of buoyancy amidships being no less than 2640 tons. The maximum hogging moment borne by the midship section is 140,000 foot-tons—more than *three times* the maximum hogging moment experienced in still water.

* See the remarks made at page 261. Special features may produce small excesses of weight at the bow or stern even when they are immersed in the adjacent wave slopes. For example, in the *Minotaur*, on the wave of her own length mentioned in the text, the heavily armoured bow has a very small excess of weight, 10 tons on 10 feet;

and in the *Devastation*, similarly circumstanced, the lowness of the freeboard leads to the extremities of the deck being buried deep in the wave slopes, causing excesses of weight of about 25 and 65 tons respectively forward and aft. But these may be safely neglected, since the resultant hogging moments are very small.

These exaggerations of strain, however, leave the character of the strain unaltered, every transverse section being subjected to a hogging moment as in still water.

Astride the wave hollow, the ship is subjected to entirely different conditions; at both bow and stern there is an excess of buoyancy of about 690 tons, and amidships an excess of weight of 1380 tons. Throughout the length sagging strains have to be resisted; and the maximum sagging moment, borne by a transverse section near the middle of the length, is about 74,800 foot-tons.

Ships of the *Devastation* type gain upon the *Minotaur* class when placed upon the wave crest, because the added buoyancy amidships is well situated in relation to the concentrated weights there placed. Hogging moments are then experienced throughout the length, but they are of moderate amount as compared with those for the *Minotaur* type. When the *Devastation* floats on a wave of her own length (300 feet by 20 feet high)—a proportionately steeper wave than that assumed for the *Minotaur*—the weight and buoyancy are distributed as follows. First 37 feet from the bow, weight 130 tons in excess; next 34 feet, buoyancy 90 tons in excess; next 35 feet (under fore turret), weight 580 tons in excess; next 84 feet (in wake of wave crest), buoyancy 940 tons in excess; next 22 feet, weight (under after turret) 160 tons in excess; next 37 feet, buoyancy 260 tons in excess; and thence to the stern, weight 420 tons in excess. This case is more complicated than that of the *Minotaur* type, just as it has been shown to be in still water. But the resultant bending moments are far less severe; the maximum hogging moment amidships in the *Devastation* is only one-fourth (36,800 foot-tons) that in the *Minotaur*.

The most critical case for the *Devastation* type is that when the ship lies astride a wave hollow, as in Fig. 88. The substitution of the wave profile for the horizontal surface of still water exaggerates the excesses of weight amidships, while the immersion of the extremities in the wave slopes decreases or does away with any excess of weight existing there in

still water. The lowness of the freeboard in the *Devastation* helps the ship in this critical position; the wave slopes cover the extremities of the upper deck, the ship sinking bodily deeper into the wave than if she had a lofty bow and stern like the *Minotaur*; consequently there are less excesses of buoyancy at the extremities, as well as less sagging moments amidships. The actual distribution of the weight and buoyancy in this position may be summarised as follows.* The first 80 feet of length from the bow, buoyancy 920 tons in excess; the first 95 feet of length from the stern, buoyancy 880 tons in excess; on the midship length of about 135 feet, weight 1800 tons in excess. These are considerable quantities, but compared with the corresponding figures for the *Minotaur* on a wave crest, they appear moderate. The resultant maximum sagging moments in the *Devastation*, experienced by a section near the middle of the length, is 51,000 foot-tons; about *two-thirds* the corresponding sagging moment for the *Minotaur*, and a little over *one-third* the maximum hogging moment for that ship.

It has been previously remarked that the fairest comparison is that which expresses the bending moments as a fraction of the product of the weight (W tons) into the length (L feet). As a summary of the foregoing remarks the following table is given.

Maximum Bending Moment.	<i>Minotaur.</i>	<i>Devastation.</i>
On wave crest—hogging	$\frac{1}{2} \times W \times L$	$\frac{1}{7} \times W \times L$
In wave hollow—sagging	$\frac{1}{3} \times W \times L$	$\frac{1}{5} \times W \times L$
In still water	$\frac{1}{8} \times W \times L$ (Hogging)	$\frac{1}{7} \times W \times L$ (Sagging)

The vessel with weights concentrated amidships is thus shown to be much the less strained; and the only additional remark that need be made in illustration of the contrast is

* See foot-note on page 274.

that the armour of an ironclad ship contributes great assistance to the hull against sagging, as compared with its assistance against hogging.

One circumstance which is apparent in the above table tells very greatly in favour of vessels with weights concentrated amidships; viz. that there is a much less difference between the maximum hogging and sagging strains experienced by a vessel of the *Devastation* type than between the corresponding strains in a vessel like the *Minotaur*. The rapidity with which these great changes of straining actions take place has already been alluded to; this contrast enables it to be illustrated. From the time that the *Minotaur* occupies the position shown in Fig. 87 to the instant when she may lie across the hollow as in Fig. 88 will be an interval of only $4\frac{1}{2}$ seconds; the straining actions at the commencement of that brief interval tend to hog the ship with a moment of 140,000 foot-tons, while at its end their character has undergone a complete change, and they produce a sagging moment of 74,800 foot-tons. The sum of these quantities — say 215,000 foot-tons — may be taken as a measure of the change of bending moment occurring about once in every $4\frac{1}{2}$ seconds. In the *Devastation*, owing to her less length, the time interval between the two extreme positions will be less than 4 seconds; the bending moment changing from 37,000 foot-tons (hogging) to 51,000 foot-tons (sagging), the sum of the two being about 88,000 foot-tons, or considerably below one-half the corresponding sum in the *Minotaur*. As between the two ships, the difference is very important; but it will be understood that the present intention is rather to deal with types and general principles than with particular ships. These principles apply, moreover, with equal force to unarmoured vessels of war or to non-combatant vessels. Mr. Reed gives the case of her Majesty's yacht *Victoria and Albert* as an illustration of the type with weights much concentrated amidships, and very fine as well as lofty extremities; showing that her condition is even more opposite to that of

the *Minotaur* than is that of a central-battery ironclad like the *Bellerophon*. As many readers may not have ready means of access to the original paper of Mr. Reed, his results for the *Bellerophon* and the *Victoria and Albert* are appended. To these we have added the results of a recent calculation for a single-turret ironclad ram somewhat resembling her Majesty's ship *Rupert*; the length of this vessel is 256 feet, beam $57\frac{1}{2}$ feet, displacement 5000 tons.*

Maximum Bending Moment.	Turret Ram.	<i>Bellerophon</i> .	<i>Victoria and Albert</i> .
On a wave crest—hogging	$\frac{1}{43} \times W \times L$	$\frac{2}{97} \times W \times L$	$\frac{1}{43} \times W \times L$
In a wave hollow—sagging	$\frac{1}{41} \times W \times L$	$\frac{1}{43} \times W \times L$	$\frac{1}{23} \times W \times L$
In still water	$\frac{1}{263} \times W \times L$ (Hogging)	$\frac{1}{176} \times W \times L$ (Hogging)	$\frac{1}{139} \times W \times L$ (Sagging)

So far as calculations have yet been carried, the types represented by the *Minotaur* and the *Victoria and Albert* lie at opposite extremes, and there is reason to believe that few *sea-going* ships will be subjected to hogging strains more severe (in proportion to the product of the length by the displacement) than is the *Minotaur*, or to more severe sagging strains than is the *Victoria and Albert*.

From the best published account of the strains experienced by merchant ships, it appears that the maximum hogging moment experienced by ordinary steamers, when floating on the crest of a wave of their own length and of maximum steepness, is about $\frac{1}{35}$ of the product of the length by the displacement, or about 20 per cent. less than in the *Minotaur* type. Astride the hollow of these waves, the maximum sagging moment experienced is considered not to exceed $\frac{1}{30}$ of the product of the length into the displacement, nearly agreeing with the *Minotaur* type. The comparative light-

* This calculation was made under the direction of the Author by one of his pupils at the Royal Naval College, Lieut. Tuxen, of the Danish navy.

ness of the unarmoured ends in the merchant ships accounts for these differences.

The late Professor Rankine, apparently without recourse to detailed calculations from actual ships, fixed upon $\frac{1}{2}$ of the product of the length by the displacement as the probable maximum hogging moment experienced by a ship on a wave crest, but this is probably outside the truth. On the other hand, he expressed the opinion that sagging strains need never become so important as hogging strains; whereas, as we have seen, in certain types of ships, the sagging moments are the severest, and proportionately quite as great as any hogging moments likely to be experienced by any types. These facts are mentioned in passing simply as illustrations of the risks run by even the ablest investigators in generalising without sufficient data; and on this ground, the desirability of further and more extensive investigations may well be urged.

All the foregoing estimates of the relative distribution of the weight and buoyancy have been made on the supposition that the ship is upright; but it commonly happens that, in a seaway, a vessel rolls through large angles, while subjected to longitudinal bending strains. Such inclinations from the upright necessarily affect the distribution of the buoyancy along the length, and without actual calculation it is not possible to ascertain how these changes may affect the bending moments. It is, however, worthy of note that the hypothetical cases in Figs. 87 and 88 represent a ship bow-on to the waves; the position in which she is likely to roll comparatively little. On the other hand, if she is broad-side-on, or nearly so, to the waves, and rolls considerably in consequence, the wave form occupies a position relatively to her length far less likely to cause such unequal distribution of the weight and buoyancy as is assumed in Figs. 87 and 88. When the ship lies obliquely to the waves, another kind of strain is developed concurrently with longitudinal bending; viz. the *twisting* tendency, produced when the bow is lying on the slope of one wave and the stern on that of

the next wave, the fore and after parts of the ship being subject to forces tending to heel them in opposite directions. But all these are matters which should influence the structural arrangements in a degree subordinate to that of the considerations which have received most attention in this chapter; and they are mentioned here chiefly because in the following chapter some notice will be taken of the manner in which the shipbuilder provides strength to resist them.

The best authorities at present agree in taking the exceptional positions illustrated in Figs. 87 and 88 as affording fair comparative measures of the maximum longitudinal bending strains experienced by ships. Some writers, including the late Sir W. Fairbairn, have, however, suggested the propriety of giving to all ships strength sufficient to resist the far more severe bending strains produced when vessels are aground and supported only at the middle of the length, or at the ends. The advantage of adopting such a standard may well be questioned, seeing that the theoretical conditions of support—viz. concentration of the support at *points* along the length—are never likely to be fulfilled, and rarely, if ever, approximated to. Many ships have grounded, no doubt, and rested either at the middle part only or else only at the ends; but a certain distribution of the support has even then been secured, and in nearly all such cases the vessels have remained partially water-borne. Moreover, accidents of this kind are of rare occurrence to any ship, and are entirely escaped by the great majority of vessels; besides which it must be remembered that failure or serious damage in grounding, &c. is far more likely to result from excessive *local* strains than from bending strains experienced by the ship as a whole. The bottoms of ships crush up, or are much damaged, very frequently before the structural strength against bending strains is over-tasked. On the whole, therefore, the generally accepted method which deals with ships *afloat* appears very much superior to the alternative proposal, based upon the condition of ships *ashore*. There are a vast number of ships which have been many

years afloat on active service, and have displayed no signs of weakness, which would utterly fail under the conditions which Sir W. Fairbairn and others would have imposed; for it appears that, in the extreme cases of support ashore, the maximum bending strains reach from four to six times the maximum strains incidental to the extreme cases of support amongst waves. In some of these vessels, no doubt, the best distribution of material has not been made, and much greater longitudinal strength might be secured by improved arrangements without increase in the total weights of hull; but in most cases it would appear an unnecessary and uneconomical plan to provide a large reserve of strength to meet a contingency that may never be encountered, and which would necessitate heavier hulls and decreased carrying power.

Only a few cases can be given, from the many that might be quoted, where vessels have grounded in a tideway and been left unsupported for considerable parts of their lengths, or have stopped in launching and been suspended in exceptional positions. The well-known case of the *Northumberland*, which stopped on the launching ways at Millwall in 1866, and remained for a month with one-eighth of her length unsupported, may be mentioned, because it has been thoroughly investigated; and Mr. Reed states that even this exceptional position did not develop such severe bending strains as would result from suspension on the wave crest. Had the ship been supported only at the middle, the case would have been very different; as it was, the ship maintained her form unchanged. A similar and more recent case is that of the Brazilian ironclad *Independenzia*, which stopped on the launching ways; her bottom crushed up, owing to the concentration of the support near the middle of the length, but we are informed that the sheer was unbroken, and no serious damage done to the structure. Very different from the condition of these iron ships was that of the wood line-of-battle ship *Cæsar*, which stopped in launching at Pembroke in 1853, and remained a fortnight with 64 feet of the stern unsupported by the ways; her stern dropping no less than

2 feet in 90 feet. Lastly, as a converse case, we may refer to the *Prince of Wales*, an iron steamer, which was left for some time, owing to an accident, supported at the ends only, her bow on the edge of a wharf, and her stern in the water; she also was uninjured.* In none of these instances were the extreme conditions of suspension at the ends or middle realised, nor are they likely to be so.

In concluding this part of the subject, it is desirable to glance once more at the conditions of strain in ships subjected to longitudinal bending moments; for the character of such strains is not affected by changes in the magnitude of the bending moment; the intensity of the strains is alone affected. When a ship hogs, the ends dropping relatively to the middle, the upper parts of her structure tend to become stretched, i.e. they are subjected to tensile strains, while the lower parts are subjected to compressive strains; and somewhere near the middle of the depth there is a part of the structure subjected neither to tensile nor compressive strains. Conversely, when a ship astride a wave hollow is subjected to sagging moments throughout her length, the lower parts are subjected to tensile strains, and the upper parts to compressive strains, the parts near the mid-depth again being free from strain. These two cases are practically of the greatest importance, because the strains of all classes of ships, when floating amongst waves, may be grouped under them, no matter what the still-water distribution of weight and buoyancy may be, and the wave-water strains are considerably greater than the still-water strains. It is worthy of note, however, that, when a ship is subjected for a portion of her length to hogging strains, and for the remaining portion to sagging strains—a condition exemplified by the *Devastation* in Fig. 86—then the upper decks and topsides of those parts subjected to

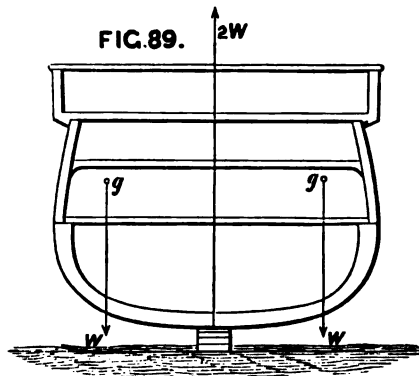
* For much interesting information bearing on the subject, see *Shipbuilding in Iron and Steel*, by Mr. Reed; Mr. Grantham's work on *Iron Shipbuilding*, and Sir W. Fairbairn's *Iron Shipbuilding*.

hogging moments tend to stretch, whereas they are subject to compressive strains at the parts subjected to sagging moments. At those athwartship sections of such a ship corresponding to the points c, c in Fig. 86, where the curve of moments MMM crosses the base-line AB, no bending moments exist, and consequently there is no development of either tensile or compressive strains. These general considerations must suffice for the present; in the following chapter we shall investigate more fully the character and magnitude of the strains resulting from longitudinal bending moments, as well as the manner in which these strains are resisted by the structure of a ship.

Attention will next be turned to the causes and character of the chief strains tending to produce changes in the *transverse forms* of ships.

The most severe transverse bending likely to be experienced by a ship at rest is that resulting from grounding or being docked. Fig. 89 will illustrate this case. Suppose

that, for an instant, the vessel is wholly supported on her keel; then the blocks or the ground must furnish an upward pressure to balance the total weight of ship and lading, and this is indicated in the diagram by $2W$ acting vertically. Considering each side of



the ship to bear an equal load, the total of hull and lading for one side of the ship is W , a downward pressure acting through g , the centre of gravity of the hull and lading of that side. The transverse distance of g from the longitudinal middle plane of the ship depends,

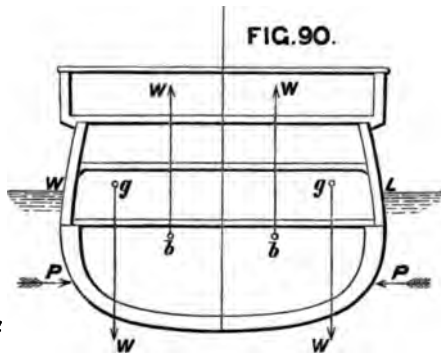
of course, on the distribution, in a transverse sense, of the weights carried. If these weights are placed centrally, g will lie much nearer to the middle plane than if the weights are "winged"—carried far away from the middle. For instance, in an armoured ship several hundred tons of armour may be carried on the broadside, and a great weight of coal in the wings; in which case g will lie far out. On the other hand, a merchant ship may have her cargo—say of rails or heavy materials—stowed almost at the centre, along over the keel; in which case g will lie near the middle plane. When the distribution of the weights is known, the position of g can be determined; the transverse bending moment will (under the conditions assumed) equal the product of W into the distance of g from the middle plane. This moment tends to make the bilges drop relatively to the middle, and to break off the ribs of the ship at the middle line.

This is an extreme case, not often realised perhaps, but sometimes occurring. A ship left aground by the retreating tide is either likely to remain partially water-borne or else, when left high and dry, she will "loll" over and rest on one of her bilges as well as on the keel. A ship, when docked, is generally supported by shores as the water leaves her; so that the upward pressure from the blocks is not equal to the total weight, nor is the transverse bending moment nearly so severe when the shores take part of the weight. It is, however, certain that ships in dock, especially wood-built ironclad ships, require to be very carefully supported by shores, in order to prevent changes of transverse form; and many cases are on record where such changes have actually taken place. The converted ironclads of the Royal Navy have, for example, been found to "break" transversely when in dock, even when well shored; and it has been suggested to use bilge-blocks in order to lessen the strains. Such blocks have been used for this purpose, both in this country and abroad, in vessels of unusual form. The American monitors are said to be thus supported when in dock; and the flat-bottomed floating batteries built for the

Royal Navy during the Crimean War were docked on bilge as well as central blocks. The reduction of transverse bending strains by these special supports is easily explained; for instead of an upward pressure W at the middle line and the downward force W forming a couple, the resultant of the pressure on the keel-blocks and bilge-blocks will necessarily lie some distance out from the middle, and closer to the line of action of the downward force W .

Ships afloat in still water are not strained so severely as vessels supported

on the keel only; for a reason very similar to that just given. Fig. 90 illustrates this case. Taking one half the ship separately, its weight W acts through g , as before explained; but the support W is



now furnished by the buoyancy of that half of the ship acting upwards through b , the centre of buoyancy for that half. Probably the case illustrated in the diagram is the most common, g lying further from the middle than b ; but in some ships with great weights of cargo stowed centrally over the keel, it is conceivable that the relative positions of g and b may be reversed, g lying nearer to the middle of the ship.

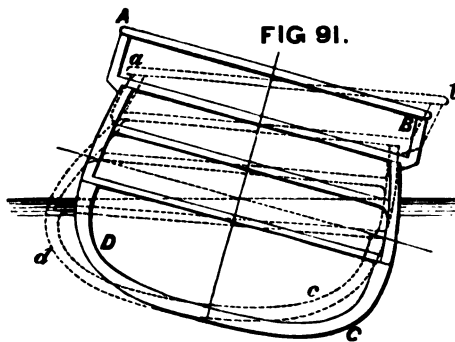
The horizontal fluid pressures also contribute towards producing changes of transverse form. The pressures P, P in Fig. 90 are equal and opposite when the ship is at rest; but as she is not a rigid body, or a solid, she tends to become compressed by the equal and opposite pressures. This is a parallel case to that given before for longitudinal bending strains; only here the pressures are much greater than for longitudinal strains. For example, Mr. Reed estimates that in the *Minotaur* the longitudinal pressures

amount to about 400 tons, whereas we find on calculation that the transverse pressures would probably amount to 3500 tons. The transverse pressures P , P may be considered to act along lines at a depth below water equal to about two-thirds of the mean draughts when the ship is upright. When she is inclined, similar, but possibly more severe, compressive strains will be caused by the fluid pressures, the tendency being to force the bilges inwards, and thus to distort the transverse form.

The most marked indications of these compressive strains are usually to be found near the extremities, where the sides are flat and nearly upright. Many instances have been noted where "panting," as it is termed, has taken place in those parts of badly constructed ships, the sides moving in and out under varying conditions. Such changes of form are, however, very easily prevented by simple structural arrangements, as will be shown further on.

Rolling oscillations lead to a great increase in the strains tending to alter the transverse forms of ships. This will be obvious, from the remarks previously made respecting the accelerating forces developed during rolling, and the changes in magnitude and direction which these forces

undergo during the motion.* When the range of the oscillation is known, and the conditions of statical stability have been ascertained for the ship it is possible to approximate to the racking strains



produced; but their general character can be understood apart from calculation. Referring to Fig. 91, the cross-

* See page 207.

section of a ship will be seen in an inclined position, representing the extreme angle of heel attained when rolling. When the motion ceases, the accelerating forces reach their maximum value, and their straining effect is greatest. This straining action tends to distort the form of the transverse section as indicated in dotted lines, changing from ABCD (*drawn* lines) to *abcd* (*dotted* lines). At the angle B there is a tendency to make the inclination of the deck to the side an *acute* angle; on the opposite side, at A, there is a tendency to make the corresponding angle *obtuse*. At the bilges corresponding changes are indicated; the general character of the change may be described as resulting from the tendency of the parts to keep moving on in the direction in which they were moving before the maximum heel was reached.* Experience fully confirms the theoretical deduction, that rolling motion develops straining forces tending to change the angles made by the decks with the sides. In wood ships, working at the beam-arms is very common during heavy rolling at sea. Beam-knee fastenings work loose, and other indications of strain or working occur. At the bilges also in wood-built steam-ships, working sometimes takes place during rolling, and unless precautions are taken, pipes, &c. will be broken at the joints, or disturbed by the change of form; in fact, the attention that has been bestowed by practical shipbuilders upon beam-knees and other fastenings intended to secure rigidity of transverse form can scarcely be paralleled from any other part of the structure.

The racking strains produced by rolling have their effect greatly enhanced by the changes in direction and intensity occurring during each oscillation; and hence it is that the range of oscillation as well as the period are such important elements in a comparison of the transverse racking strains

* It will be understood that in Fig. 91 the distortion is very much exaggerated for the sake of illustrating the tendency.

experienced by two ships. Allusion has already been made to this in discussing the behaviour of ships at sea, but it is desirable to further illustrate the matter, and for this purpose it is necessary to make use of an approximate rule for the maximum value of these racking strains. The late Professor Rankine, whose labours in connection with naval architecture were worthy of his high reputation in other branches of research, has proposed such an approximate rule, which is as follows :—*

$$\text{Moment of racking forces} \left. \begin{array}{l} \text{of racking} \\ \text{forces} \end{array} \right\} = \frac{D^2}{D^2 + B^2} \times \left\{ \begin{array}{l} \text{Righting moment for} \\ \text{maximum heel at-} \\ \text{tained,} \end{array} \right.$$

where D = total depth of ship from upper deck to keel,
 B = breadth of ship.

Applying this rule to two typical ships, one having a short period like the *Prince Consort* class, and another having a long period like the *Hercules* class, a remarkable contrast becomes apparent. Actual observations show that the *Hercules* only rolled 15 degrees on each side of the upright when a converted ironclad was rolling 30 degrees each way. Suppose these figures to be used. For these two vessels, B and D , are approximately equal, the ratio $\frac{D^2}{B^2 + D^2}$ being about 1 to 3 for each ship. Assuming this ratio to be used, it is found that the moment of racking forces at the extreme of the heavy roll of the *Prince Consort* would be about 7000 foot-tons, and the corresponding moment at the extreme of the moderate heel of the *Hercules* would be about one-third as great. The *Prince Consort* has a period of about 5 seconds; consequently, twelve times every minute a racking moment of the amount stated will be acting upon her structure, and at intervals of 5 seconds the distortion will tend to take place in opposite directions. In the *Hercules*, with a

* See page 155 of *Shipbuilding, Theoretical and Practical*.

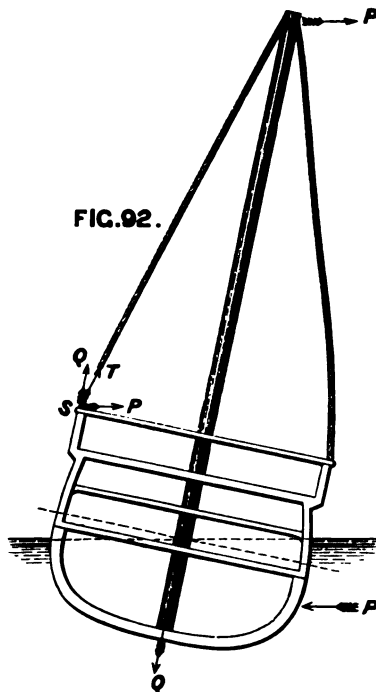
period of about 8 seconds, a racking moment less than one-third the amount of that in the *Prince Consort* will be acting only seven times every minute, and the tendency to distort will change its direction at intervals of about 8 seconds. The less frequent change of strain and the diminished moment tell greatly in favour of the slower-moving and steadier ship. What has here been shown to hold good for particular ships holds good also for ships in general. Lengthening the period of still-water oscillations not merely makes ships steadier in a seaway, but greatly reduces the effect of strains tending to produce changes in the transverse forms, or damage to the masts and rigging. Deep-rolling ships are also the quickest in their motions, and require the greatest strength in hull and equipment.

Little need be said respecting the strains produced by the propelling apparatus upon the structure of a ship considered as a whole, although this third class of strains is by no means unimportant. When a ship is propelled by sails, the effective wind pressure may be resolved into two parts: one acting longitudinally and constituting a "thrust" which propels the vessel on her course; the other acting transversely, producing leeway and an angle of steady heel. When the motion of the vessel is uniform, the longitudinal thrust exactly balances the fluid resistance to the motion ahead; the thrust and resistance form a mechanical couple; and the "centre of effort" of the sails, where the resultant thrust may be supposed to be delivered, will be at a great height above the line of action of the fluid resistance. This couple by its action must produce two effects on the ship: first, a change of trim—deeper immersion by the bow—corresponding to its moment;* second, a longitudinal racking action upon the structure of the ship. The character of this racking action may be simply illustrated by taking

* For the principles upon which the calculation of this trim would be based, see Chapter III. page 89.

a rectangular frame formed of four pieces of wood, joined to one another at the angles, and supposing either pair of its parallel sides to be acted upon by forces equal in magnitude, but opposite in direction. Obviously, the rectangle would become distorted into a rhomboid, unless the connections were very strong; but by means of a diagonal tie, like that on an ordinary field-gate, this racking or change of form may be very easily prevented. The corresponding tendency in ships is also unimportant, because of the large reserve of structural strength to resist such strains.

The heeling produced by the transverse component of the wind pressure has already been investigated;*



it has been shown to result from the moment of the couple formed by the wind pressure (P , Fig. 92) and the equal and opposite resistance of the fluid when the drift to leeward has become uniform. This couple must produce a tendency to distort the transverse form of the ship, and the character of the distortion which it tends to produce will be better seen from the following considerations. The shrouds on the windward side will be taut, and have a tension T upon them. If α be the angle of the shrouds with the vertical, and the pressure P acts horizontally (by the

* See page 62; for further explanations see Chapter XII.

parallelogram of forces), $T = P \operatorname{cosec} a$. This tension has to be resisted, primarily, by the strongly constructed channels and chain-plates, through the connections of which it is transmitted to the hull. It also gives rise to a thrust delivered by the mast upon its step; and when the angle of the shroud with the mast is known, say β , $Q = T \cos \beta$ is an equation, giving Q in terms of T ; thence Q can be expressed in terms of P , the transverse component of the effective wind pressure. The pull of the shrouds on the chain-plates (at S , Fig. 92) is also resolvable into two components: Q , acting parallel to the thrust of the mast, and P , acting parallel to the resistance to leeway. The couples thus formed tend to produce changes of transverse form, and their separate racking tendencies will be easily distinguished; the thrust couple predominates over the other. Professor Rankine estimated the probable maximum bending moment of these forces at one-half the moment of statical stability corresponding to the angle of steady heel; and on applying to the foregoing expressions the average values of the angles of shrouds with the masts, it will appear that this estimate is a fair one. Even for the largest ships the angle of steady heel corresponding to the full spread of sail is, however, so small as to make this bending moment practically unimportant as regards its effect upon the ship considered as a whole. But the necessity for careful connections at the channels and chain-plates is a point of great practical importance, being a provision for a *local* strain; and the proper construction and staying of the masts in a sailing ship is also a matter requiring careful arrangement.

The foregoing remarks are based exclusively upon statical considerations, the wind pressure being assumed *constant* and the angle of heel *steady*. It must not be forgotten, however, that very much more serious consequences may result from the action of gusts, or squalls of wind, applied suddenly; and to the rolling and lurching which take

place when ships are among waves.* Such great and variable strains, of which the amounts are not easily ascertainable by any general law, can only be met by the most careful construction of the masts, and selection, as well as arrangement, of the rigging. Neglect of proper precautions has very frequently led to the dismasting of sailing ships, especially those built of iron and with iron masts, in the mercantile marine. Within the last two or three years the subject has become so important as to receive special attention from the Committee of Lloyd's Registry, whose rules exercise so great an influence upon the construction of merchant ships. In the Royal Navy accidents of this kind are scarcely known, every care being taken to prevent them. Masts must have considerable strength in themselves to resist both the bending strains tending to break them off near the deck and the compressive strains due to the thrust produced by the tension of the shrouds; they must be associated with strong shrouds and stays, having a good spread (i.e. making as large an angle as possible with the mast), and these must be well secured to the sides of the ship by channels, chain-plates, &c. The details of all such arrangements are, however, settled rather by comparative methods than by purely scientific methods. The particulars of ships which have borne successfully the strain and stress of service are made the basis of corresponding features in other ships; and where special causes intervene, special precautions are taken. For example, in her Majesty's ship *Monarch*, where it was desirable to remove all possible obstacles to the fire of the turret guns, the masts were made of exceptional size and strength, in order that they might be capable of standing with fewer shrouds than usual when the ship was cleared for action. In other ships, where the spread of the rigging has been less than usual, the shrouds have been made exceptionally strong. Rigid tripod

* See the remarks on wind squalls at page 139, and also refer to the illustration of transverse straining due to reaction in rolling at page 288.

supports to the masts have also been used, instead of numerous wire shrouds, in turret-ships and vessels wherein an unusual horizontal range of fire for the guns was desired. This plan was adopted in the *Captain*. Such precautions are, however, local and special, not affecting the structure of the ship; and they are only mentioned, in passing, because of their great practical importance, limits of space preventing any separate discussion of the subject.

With steam as the propelling agent, the case is simpler than with sails. The thrust of the propeller will usually be delivered in the direction of the course of the ship, and will therefore have no transverse component; moreover, the line of action of that thrust will lie very much closer than it does with sail power to the line of action of the fluid resistance; consequently the tendency to produce longitudinal racking or distortion of form will be very much lessened. When the screw is employed, the line of thrust for the propeller approximates to coincidence with the line of action of the resistance; and even when paddles, or jet propellers, are used, the thrust is delivered at a comparatively small height above the line of action of the resultant resistance. It is unnecessary, therefore, to add any further remarks on this part of the subject, the ship considered as a whole being but little strained by the propelling apparatus.

The last class of strains to be considered are those grouped under the head of *local strains* in our classification. Of these, there is such a great number and variety that an exhaustive treatment of the subject will scarcely be found in works on shipbuilding; and all that can be done in the present sketch is to select a few of the principal types, indicating the causes and character of the strains. As a matter of convenience, we shall adjoin, in each case, a brief account of the arrangements by which the strain is prevented from producing local damage or failure.

At the outset it may be well to note that the same

circumstances which have already been mentioned as producing strains upon a ship *considered as a whole* may and do produce severe local strains. For example, a heavy load concentrated in a short length, not merely contributes to the longitudinal bending moment previously described, but also tends to push outwards that part of the bottom upon which it rests. Similarly, the thrust of a screw propeller not only tends to rack the ship as a whole, but produces considerable local strain on that part of the ship to which the "thrust-bearer" is attached. Again, the downward thrust of a mast, besides tending to alter the transverse form of the ship as a whole, produces a considerable local strain on the step, and on the frame of the ship which carries the step. And these are only a few illustrations of a general principle. When the ship is treated as a whole, it is virtually assumed that these local strains have been provided against; so that the various parts of the structure can act together and lend mutual assistance. As a matter of fact, however, it is not at all uncommon to find local failure supervening long before the limit of the strength of a ship considered as a whole has been realised. The case of the *Indipendenza*, previously quoted, well illustrates this; when she stopped in launching, her general structural strength was ample even against the severe bending moments experienced; but while her longitudinal form remained almost unchanged, the very exceptional local strains on a small portion of the bottom forced it inwards, disturbing the decks, &c. above it. Many similar examples might be added, but enough has been said to show how important it is to provide carefully against local strains in arranging the structure of a ship.

One of the chief causes of local straining has already been mentioned; viz. a great concentration of loads at certain parts of a ship; and the converse case is also important—that where there is a great excess of buoyancy on a short length. Examples have been given of such concentration of loads; one of the most notable is that for the *Devastation*,

in wake of the turrets (see Fig. 85), where there is an excess of weight over buoyancy of 550 tons on a length of about 30 feet. Still more concentrated is the load of armour on a battery bulkhead, weighing perhaps 60 or 80 tons, and lying athwartships. Immediately in wake of such concentrated loads the bottom tends to move outwards from its true shape; the local strain which is developed tending to produce simultaneously both longitudinal and transverse change of form. Many similar causes of straining will occur to the reader; it is only necessary to mention the cases of a vessel with a heavy cargo, like railway iron, stowed compactly, or of a vessel with heavy machinery carried on a short length of the ship, or of the parts adjacent to the mast step of a sailing ship.

Surplus buoyancy on a ship afloat is not usually found so much concentrated as surplus weight; but in some instances the excess of buoyancy produces a considerable local strain tending to force the bottom upwards. When a ship grounds, her supports are often so few and small that the bottom cannot withstand the concentrated upward pressure, which then produces considerable local damage. This is, however, an uncommon case, and one which the shipbuilder can scarcely hope to provide against satisfactorily.

To prevent local deformations of the bottom in wake of excesses either of weight or buoyancy, the shipbuilder employs a very simple and well-known device. The concentrated load or support is virtually distributed over a considerable length by means of strong longitudinal keelsons, bearers, &c. In not a few cases these longitudinal pieces are additions to the main framing or structure of the ship; in other cases they form part of the main structure, being effective against the principal strains as well as against local strains. The latter plan is preferable, where it can be adopted, favouring, as it does, lightness and simplicity of construction. These longitudinal bearers and strengthenings can only distribute loads or upward pressures when they are individually possessed of considerable strength; and

this is easily secured. Generally the longitudinals must be continued through a length sufficient to connect and secure the mutual action of parts where there is an excess of weight with others where there is an excess of buoyancy. But in very many ships, and especially in iron ships, there are cross-sections, like those at bulkheads, where alteration of the form is scarcely possible. In such cases the bearers distributing a concentrated load or pressure frequently extend from one of the strong cross-sections to the next: just as the girders of a bridge extend from pier to pier, and, if they are made sufficiently strong, can transmit a concentrated load placed midway between the piers to those supports without any sensible change of form.

The *Great Eastern* furnishes a good example of the last-mentioned arrangement. In the lower half of her structure there is very little transverse framing. Numerous and strong transverse bulkheads supply the strength requisite to maintain the transverse form unchanged. Strong girders, or frames, extend longitudinally from bulkhead to bulkhead, and transmit the strength of the bulkheads to the parts lying between them. Arrangements of a similar, but not identical, character are also made in the ironclad ships of the Royal Navy, and will be illustrated in the following chapter.* The engine and boiler bearers in many iron steamers are also arranged on this principle.

Vessels with few transverse bulkheads, or with none, have strong keelsons, binding strakes, stringers, and other longitudinal strengthenings on the flat of the bottom below the bilges, these pieces distributing loads and adding to the structural strength. This is the common arrangement in wooden ships of all classes, as well as in iron sailing ships. Recently, however, in the wood-built ships of the Royal Navy and the French navy iron bulkheads have been constructed, and, in some cases, iron bearers and keelsons have been fitted. The wood-built American river steamers

See Fig. 104, page 331.

furnish curious illustrations of the connection of parts of a ship having surplus buoyancy with others having surplus weight. Besides strong longitudinal keelsons, the builders have recourse to the "mast-and-guy" system. Poles or masts are erected at parts of the structure having surplus buoyancy; these masts are stepped upon strong timber keelsons. Chain or rod-iron guys are then secured to the heads of the masts and connected at their lower ends to parts of the vessel where considerable weights are concentrated, thus hanging these parts on, as it were, to the buoyant parts. In this fashion, the long fine bows and sterns are prevented from dropping; and, in wake of the machinery, tendencies to alter transverse form are similarly resisted. Such arrangements are, of course, only applicable to vessels employed in smooth water, not subjected to the changes of strain to which sea-going ships are liable. The guy-rods can transmit tension, but not thrust; and the plan is said to have answered admirably in these long fine vessels, having great engine-power and high speed.

Grounding is another cause of more or less severe local strains, the intensity depending upon the amount and distribution of the supports. Very concentrated supports, as has already been shown, may crush up the bottom; distributed support such as a ship obtains when docked or fairly beached produces strains which can be easily met. Every provision described above for giving stiffness to the bottom of a ship is also efficient in helping her when aground. In fact, to these provisions shipbuilders mainly trust, making few special arrangements against local strains due to grounding, and these almost wholly at the extremities. Nor is this surprising, for it is impossible to foresee all the conditions of strain, or to provide against them. Such accidents to any individual ship are comparatively rare, and in iron ships the damage which results, even when it is very serious, can be repaired much more easily than is possible in wood ships. Examples will be given in Chapter X. illustrating this difference.

Penetration of the skin of a ship ashore often takes place without any serious crushing up of the bottom; and this danger is of peculiar importance to iron ships, having skin plating never exceeding an inch in thickness, and in the great majority of cases less than half that thickness. Sharp hard substances, such as rocks, will penetrate the plating more readily than they will penetrate the much thicker bottom of a wood ship. This superiority of wood ships in sustaining rough usage ashore without penetration of the bottom is well known; and some persons have attached such importance thereto as to advocate the construction of ships with wooden floors and bottom planking, but otherwise of iron. The plan has, however, obvious disadvantages, and has not found much favour with ship-builders, who prefer to accept this occasional disadvantage of iron, rather than to sacrifice its superiority in other respects to wood.

It is sometimes assumed that iron bottoms are more inferior to wood in their resistance to penetration than is really the case. To the experiments of the late Sir W. Fairbairn, we owe more exact knowledge on the subject than was previously accessible; in these experiments, a few comparative tests were made of the resistances of wood planks and iron plates to the punching action of a very concentrated support.* Under the experimental conditions an oak plank 3 inches thick was found equal in resistance to an iron plate $\frac{1}{4}$ inch thick; and a 6-inch plank to a plate 1 inch thick. Planking appeared to offer a resistance proportional to the *square* of the thickness; whereas iron plating offered a resistance proportional to the thickness only. The largest iron ships have, therefore, bottom plating about equivalent to a 5-inch or 6-inch oak plank. This would be quite as thick as, or thicker than, the average bottom planking of large wood ships; but within this planking the wood ship

* See the account of the experiments given in Sir W. Fairbairn's work on *Iron Shipbuilding*.

probably would have solid timbers and fillings, forming a compact mass, very difficult of penetration, the iron ship having no similar backing to the thin plating. It is therefore easy to see why wooden ships are, as a rule, capable of standing more of the wear and tear incidental to grounding than ordinary iron ships with a single bottom. To attempt to increase the thickness of the bottom plating in order to meet this comparative disadvantage would be wasteful and unwise; the preferable course is to fit an inner skin within the frames, forming a double bottom. Then, if the outer plating is broken through, and the inner still remains intact, no water enters the hold, and no serious damage ensues, as explained at length in the first chapter.

Such a cellular construction of the double bottom has a further advantage well deserving consideration. Thin iron or steel plating, stretching over the spaces between transverse frames, not unfrequently shows signs of bending or "buckling" between these supports when subjected to the upward or sideways pressure of the water; and this effect may be aggravated by the strains due to hogging. By means of longitudinal frames or keelsons running along upon the plating, and attached to it, buckling may be prevented; but when, in addition, an inner bottom is worked, buckling becomes almost impossible. The experiments made before the construction of the tubular railway bridge across the Menai Straits was begun first demonstrated the great advantages obtained by the cellular system applied to wrought-iron structures, especially in those parts subjected to compressive strains. Since then the knowledge of this fact has been made generally useful, both in ship and in bridge construction; but even yet not so fully as it might be, for the use of a double bottom involves some loss of internal cargo-carrying space in a merchant ship, which owners are loth to sacrifice.

When a ship sags, the upper deck and topsides are subject to compressive strains; to meet these, as well as hogging strains, more efficiently, a cellular construction of the deck has in

some few cases been adopted. The *Great Eastern* is a case in point, to which reference will be made hereafter. Longitudinal supports are not commonly fitted to decks; the wood planks usually assisting to prevent buckling in the iron or steel plating, if any is fitted.

The local strains on the decks of ships constitute another important group. Very heavy weights are placed upon certain parts of the decks, resting only upon a certain number of the deck-beams; and no little care is needed in connecting the beams with the sides of the ship, arranging the pillars beneath them, or taking other means to distribute the load. If the loads to be carried were known, and the kind of pillaring determined, it would be a comparatively easy matter to fix the dimensions of the beams required to support the loads. In practice, however, these conditions are not commonly fulfilled, and the breadth of the ship amidships, or some other dimension, is had recourse to in proportioning the sizes of the beams. Special cases occur, especially in war-ships, where the loads to be carried are excessively great, and their positions can be fixed; as, for example, the turrets of a vessel like the *Devastation*, or the guns in the battery of a broadside ship. Beams of exceptional strength, or beams spaced more closely than at other places, are often employed in such cases; but even then it is not sufficient to regard the beams as girders supporting certain loads, with the assistance of the pillars. Both beams and pillars, besides meeting these local strains, have to assist in the maintenance of the transverse form of the ship, as will be shown in the next chapter. Sometimes it happens, especially in wake of the machinery or boilers, that it is difficult to fit pillars under some of the beams; but these beams are easily supported by longitudinal girders extending a sufficient distance fore and aft to have their ends upheld by very strong pillars.

Another class of local strains, of special importance in a war-ship, are those brought upon the bows by collision with another vessel. The importance of ram attacks is now so

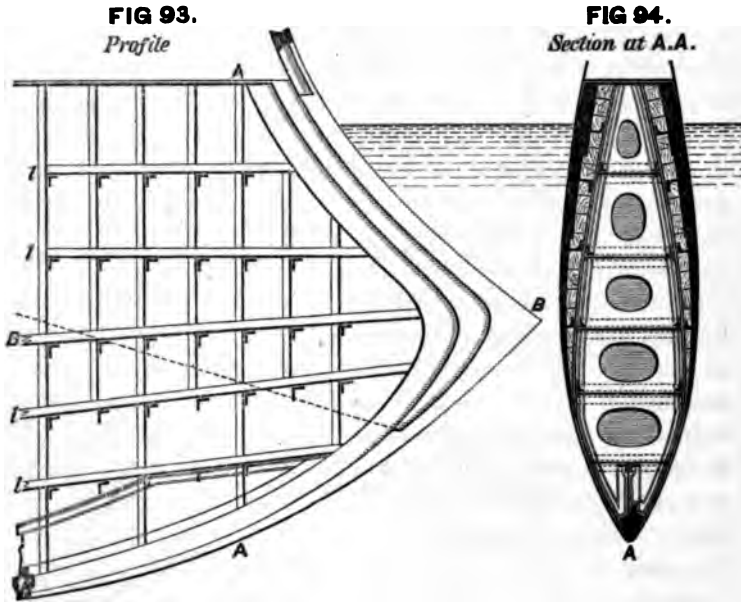
generally recognised that the great majority of the ironclad ships of all navies have been constructed with bows specially designed for delivering an effective blow upon an enemy without receiving serious damage themselves. Spurbows, protruding forward under water in such a fashion as to be able to strike the comparatively weak bottom below the armour of the ironclad attacked, are those which find most favour. Whatever may be the form of bow adopted, it must be made exceptionally strong if it is to successfully withstand the shocks and strains produced by ramming. These strains may be arranged in three divisions: (1) direct strains, tending to drive the stem and bow bodily backwards into the ship; (2) twisting strains, tending to wrench the bow off when the blow is struck obliquely, or the vessel attacked has motion across the bow of the ram-ship; (3) strains tending to perforate the skin of the ram-bow, resulting from the jagged parts of the hull of the vessel which has been struck pressing upon the ram, while the two vessels are locked together, and while the wrenching just mentioned takes place. Similar strains act upon the bow of any ship which comes into collision with another; and unfortunately there are too numerous instances of the truth of this statement in the records of accidental collisions between vessels of the mercantile marine, or other ships not built for ramming. In fact, it is to these ordinary vessels, and not to ships specially designed for ramming, that one must look for the fullest evidences of the character of the strains incidental to collision. The bows of many ships have actually been crushed in; or the skin has been penetrated; or wrenching strains—as in the ill-fated *Amazon*, of the Royal Navy—have been so serious in proportion to the strength of the bow as to twist the latter and cause the ship to founder. On the other hand, we have ample evidence that the special arrangements of ram-bows provide satisfactorily against strains which are fatal to weaker bows.

At Lissa, the Austrian ram *Ferdinand Max*, a wood ship

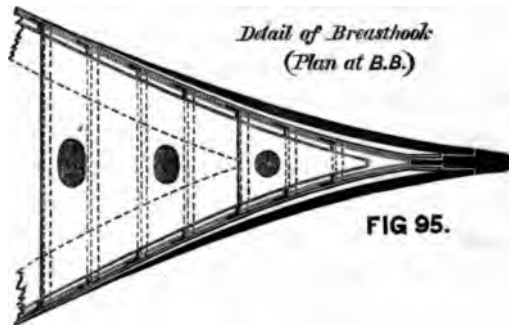
with a strengthened ram-bow, struck and sank the *Re d' Italia*, besides making other less successful attacks on other Italian ships; yet her bow sustained no serious damage, although it suffered more than an iron-built ram would have done under similar circumstances. The improvised Confederate ram *Merrimac* sank the Federal wooden frigate *Cumberland* at Hampton Roads, but wrenched her own spur badly in consequence of its faulty construction, and is said to have been consequently far less efficient in her subsequent fight with the *Monitor*. The disastrous collision between the *Vanguard* and the *Iron Duke* furnished one of the severest tests yet put upon the strength of the ram-bow in one of the modern types of iron-hulled iron-clads. To understand the severity of the test, it is necessary to note a few facts given in evidence before the court-martial. At the time of the collision the *Iron Duke* is said to have been going $7\frac{1}{2}$ knots, her course being six points off that of the *Vanguard*; the direct force of the blow delivered was at least 12,000 foot-tons. Fig. 26, page 35, illustrates the damage done to the *Vanguard*, the armour being driven in bodily and the outer bottom pierced by a huge hole some 20 or 30 square feet in area. Such a blow, of course, reacted on the bow of the *Iron Duke*, tending to drive it back into the ship; and meanwhile the *Vanguard* had a speed athwart the bow of the *Iron Duke* of no less than 6 knots, the motion producing a tendency to twist and wrench the bow, as well as to perforate the skin. The simple and comparatively light arrangements of the ram-bow answered admirably when thus severely tested, subsequent examination proving it to be so little damaged that the *Iron Duke* could, in action, have ventured safely on a repetition of the blow, and yet have remained efficient. Special interest attaching to this matter, Figs. 93-95 have been drawn to illustrate the principal features in the framing of an iron-built armoured ram-bow; and only a few explanatory remarks will be required.

The stem is a solid iron forging, weighing several tons.

Against direct strains tending to force it backward, it is supported by the longitudinal frames or breasthooks (*l, l,*



in Fig. 93), as well as by the armour-plating, backing, and skin-plating, all of which abut against the stem. The breast-



hooks are very valuable supports, being very strong yet light; their construction is shown in Fig. 95; and the foremost ends of the decks are converted into breasthooks

in a somewhat similar manner. Wrenching or twisting strains are well met by these breasthooks, stiffened as they are by numerous vertical frames, the details of which appear in Fig. 94, while their positions are indicated in Fig. 93. Perforation of the skin is rendered difficult either by carrying the armour low down over the bow or by doubling the skin-plating forward below the armour. The former plan is preferable, being more efficient against perforation, and also giving protection against raking fire when engaged bow-on to an enemy; it has been very generally adopted of late in the Royal Navy, and the French also favour this plan. Although the transverse framing of the ram-bow is thus quite subordinated to the longitudinals (*l, l*), it plays an important part in binding the two sides together, stiffening the breasthooks, and enabling a minute system of watertight subdivision to be carried out. Even if the outer skin should be broken through in ramming, water would find access to a very limited space, and consequently there would be little or no danger, and no inconvenient change of trim. Such are the main features of the ordinary ram-bow in an iron-built ironclad ship.

Recent ships of the central-citadel type are somewhat differently constructed for ramming. The armoured deck, situated several feet under water, is the strongest part of the structure which contributes the greatest support to the spur-bow. These decks are usually curved downwards at the fore end, for the purpose of gaining such a depth below water as will enable the spur to pierce an enemy below the armour. The spur is attached to the fore end of the deck; by which it is supported most efficiently against direct and wrenching strains. Subsidiary supports, breasthooks, &c. are also employed to a small extent; and in some cases arrangements have been made by which, if the spur should become locked in the side of the vessel attacked, it might actually be wrenched off without any serious damage to the bow. Perforation of the skin below the armour deck is provided against by doubling the plating.

Ram-bows in wood ships may be made fairly efficient,

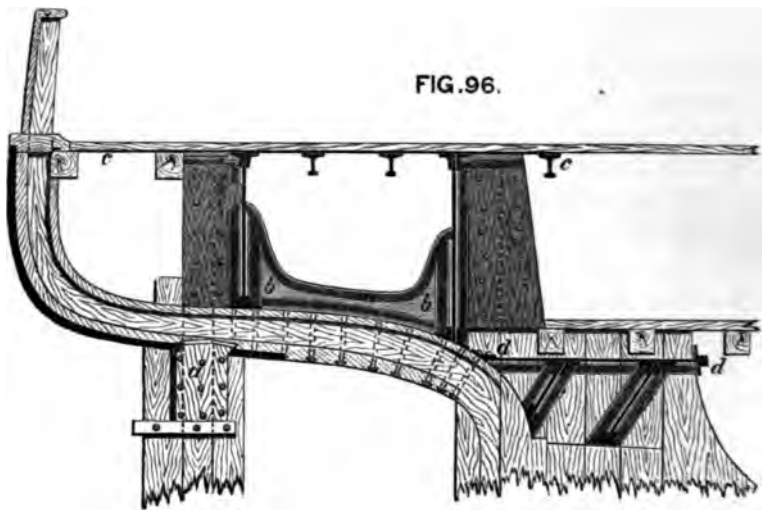
but not so simply or satisfactorily as those of iron ships, the difference being one inherent in the materials. To make the spur more efficient, it is usually armed with a sheath of metal or iron. Massive longitudinal and diagonal timbers are bolted inside the frames, and associated with iron crutches or breasthooks, to prevent the stem from being driven in or twisted when a ram attack is made. But even when all possible care is taken in fitting and fastening these strengthenings, the combination can scarcely be considered satisfactory. Weakness, working, and decay must affect it, as they do all other parts of a wooden structure. Repairs to such a bow must also prove difficult and expensive, as compared with the corresponding work in an iron-built ram, where all the parts are easy of access, and easily replaced. These are, however, matters of detail requiring no further consideration here, although they have great practical importance.

The superior strength of the bows of iron ships has been illustrated frequently in the mercantile marine, as well as in war-ships. Commonly, when collisions take place between two iron ships, the vessel struck is seriously damaged, perhaps founders, while the striking vessel escapes with little damage to her bows. Mr. Grantham quotes one case of special interest.* Nearly twenty years ago, when the *Persia*, the first iron-built Transatlantic steamer, was on her first voyage, she closely followed the *Pacific*, a wood steamer, and both are reported to have fallen in with large ice-floes. The *Pacific* was lost with all on board; the *Persia* ran against a small iceberg at full speed and shattered it, but sustained no serious damage.

The last class of local strains to be mentioned are those incidental to propulsion. Some of these have already been alluded to, viz. the strains connected with propulsion by sails, and those resulting from the attachment of the thrust-bearer to the hull of a screw-steamer. To these may be added

* In his work on *Iron Shipbuilding*.

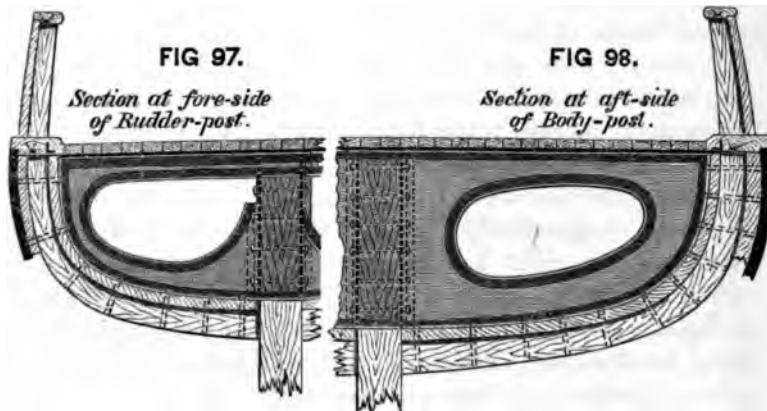
the strains produced by the moving parts of an engine, through the bearers to which they are secured ; vibration or working at the stern of screw-steamers ; strains in wake of the shafts of paddle-steamers ; and many others. The whole subject is, however, one of detail, requiring to be dealt with during the construction of the vessel by her builder and the maker of the engines. Here again the general principle of *distribution of strain* underlies all the arrangements made. The parts upon which the strains are primarily impressed must be succoured by other parts of the structure,



with which they must be connected as rigidly as possible. Changes in the relative positions of the various parts cannot occur so long as the connections are efficient, and without such changes working cannot take place. Iron is a far better material than wood for making the connections, and it has been employed very generally for the purpose, even in wood ships, with great success. Vibration may, of course, occur without any absolute working in the structure ; for either the ship as a whole may vibrate to and fro, or the observer may be deceived as to motion in

the structure by movements in platforms, or minor fittings forming no part of the structure regarded as a whole, and incapable of resisting strains or transmitting them. This distinction is especially important in vessels of great engine-power and high speed, wherein vibration, either real or apparent, may be considerable, whereas there is absolutely no working.

A single illustration of the usefulness of iron strengthenings in resisting local strains due to propulsion must suffice. Figs 96-98 contain the details of one of the best examples that could be chosen; representing the arrangements at



the stern of one of the wood-hulled ironclads of the Royal Navy. Similar strengthenings have been extensively used in unarmoured wood ships. They were introduced in consequence of the serious working and weakness not unfrequently experienced at the sterns of the earlier screw steam-ships with good engine-power; and by their use these objectionable results have been altogether prevented. Inside the ship (see Fig. 96) the upper parts of the two stern-posts are cased with iron plates; the heads of the posts are secured to iron plating (*cc*) worked on the upper beams. Between the two posts an iron knee (*bb*) is fitted, and strongly secured to the posts and to the counter of the ship.

With a lifting screw, this knee could not be fitted, but the screw-well might then be made an efficient strengthener. Partial bulkheads of iron are built across the stern at the fore side of the rudder-post and the aft side of the body-post. The construction of these is shown in Figs. 97 and 98; their upper edges are secured to the deck-plating (*cc*), while their outer edges are bolted to the sides of the ship. Change of form is thus rendered practically impossible at those two sections. Change in the angle between the counter and the rudder-post is rendered difficult by the external metal knee *a*, Fig. 96, bolted to the post and the counter. Formerly these counter-knees constituted the main strengthening at the sterns of wood ships, and they were very frequently broken in the "throat" by the working of the post produced by the action of the propeller; now such accidents are scarcely known in the Royal Navy. The body-post is also strongly connected to the hull by the iron plating (*dd*, Fig 96) under the lower-deck beams, and the brackets (*ee*). By these comparatively light and simple additions of iron strengthenings, what had been previously found an almost insoluble problem has been satisfactorily dealt with. This is but one example from the many which any reader interested in the subject will discover on investigating the details of construction in various classes of ships.

CHAPTER IX.

THE STRUCTURAL STRENGTH OF SHIPS.

THE structural arrangements now adopted in various classes of ships are the results of long continued development. Their origin is lost in antiquity, and many of the succeeding steps cannot be traced. During long periods, under the same conditions, methods of construction have remained unchanged; but altered circumstances and fresh requirements have produced great and rapid changes. From the canoe hollowed out of a single tree, or the coracle with its light frame and flexible water-tight skin, on to the enormous floating structures of the present time is a very remarkable advance; but the steps have been gradual, and not unfrequently unintentional, the full value of a new feature not being recognised until long after its introduction. The history of this gradual change and improvement, culminating in the wonderful progress of the last half-century—into which have been crowded the development of ocean steam navigation, the introduction of iron sea-going ships, and the use of armoured war-ships—constitutes a most interesting field of study; but in the present work it cannot be touched. Nor can the structural arrangements of existing types of ships receive any detailed illustration, for which the reader must turn to strictly technical treatises on shipbuilding. It will be our endeavour—bearing in mind what has been already said respecting the causes and character of the principal strains to which ships are subjected—to make clear the general principles governing

the provision of their structural strength. In doing so, it will be possible to illustrate the distinctive features in the principal classes of ships, to compare the relative efficiencies of various methods of construction, and to contrast the degrees of importance attaching to different parts of the hull of any ship. All that will be assumed is that the reader has a general acquaintance with the names of the different parts; and in most cases even that extent of knowledge will scarcely be requisite in order to follow the discussion.

All ships may be said to consist of two principal parts: (1) the water-tight skin forming the covering of their bottoms, sides, and decks, if they have decks; (2) the framing or stiffening fitted within the skin to enable it to maintain its form. There are many ways of forming the skin in different classes of ships; some of these will be described. Wood, iron, and steel are the three materials at present used for the purpose in sea-going ships; brass skins have been fitted to some small vessels designed for smooth-water services. A skin is an essential part of every ship; and much care and skill are required in its arrangements. Vessels have been built with little or no framing; but these are not ordinary cases, and probably the greatest varieties of practice are to be found in the arrangement of the framing, which constitutes a very important element of the structural strength. In constructing both skin and framing, and considering every detail of the hull, the shipbuilder should seek most fully to combine strength with lightness. To do this, he must possess an intelligent acquaintance with the causes and character of the strains to be resisted, their possible effects upon different parts of the structure, and the principles of structural strength. He is then able to choose from among the materials obtainable those best adapted for his purpose; he can duly proportion the strength of the material to the strains on the various parts, massing it where requisite, or lightly constructing parts subject to little strain; and so far as

the requirements of convenience and accommodation, or of fighting efficiency, permit, he can approximate to an ideally perfect structure, in which each part is equally strong as compared with the strain it has to bear. No structure is stronger than its weakest part; consequently a bad distribution of the materials can only be made at the sacrifice of strength, which might be secured if the material were distributed more in proportion to the straining forces.

Another important practical matter is that of the connections and fastenings of the very numerous pieces making up the hull of a ship. Unless great care is taken, the ultimate strength of these pieces will never be developed, and the structure may fail through lack of rigidity, even when it contains an amount of materials which would be ample if they were properly combined. The character of these connections must bear an intimate relation to the qualities of the materials. With wood they are necessarily different from what they would be with iron or steel. In fact, the builder has to consider this feature in making the choice of his material; having regard not merely to the ultimate resistance of a *single piece* to tensile or compressive strains, but also to the possibility of making a *combination* of two or more pieces efficient against such strains. Having made his choice, he has to effect the best possible connections and combinations, often at no small cost, in order to secure the joint action of the various pieces, and the rigidity of the structure considered as a whole.

In the present chapter it will be convenient to assume that the best possible results have been secured by the builder in each class of ship, and then to investigate their resistances to the *principal* bending strains, tending to alter the longitudinal and transverse form. Local strains have received in the preceding chapter all the attention that can be given them; and in the succeeding chapter we shall illustrate the capabilities of wood, iron, and steel as materials for shipbuilding.

The severest strains to which ships are subjected are those tending to produce longitudinal bending; and therefore the greatest strength is requisite to prevent change of form in that direction. If the ship were subjected to excessive bending moments, developing strains greater than her strength could resist, their ultimate effect would be to break her across at the transverse section where the strains reach their maximum; and this section would usually be situated near the middle of the length. Unfortunately, cases are on record where this ultimate effect has been produced, and vessels, when very severely strained, have actually broken across;* but ordinarily, instead of actual fracture, we have only to consider a tendency to produce fracture at any cross-section of the ship, the structural strength being ample in proportion to the strains. In either case one thing is clear, viz. that resistance to longitudinal bending or cross breaking at any transverse section of a ship can only be contributed by those pieces in the structure which *cross* the probable line of fracture, i. e. the particular transverse vertical section of the ship which is being considered. Pieces lying longitudinally or diagonally in the ship may fulfil this condition, and therefore contribute to the longitudinal strength; but pieces lying transversely, such as a transverse rib or frame or beam adjacent to the line of fracture, do not cross it, and therefore do not contribute to the longitudinal strength. By this simple rule it is, therefore, easy to distinguish those parts of the hull which are efficient against the principal bending moments.

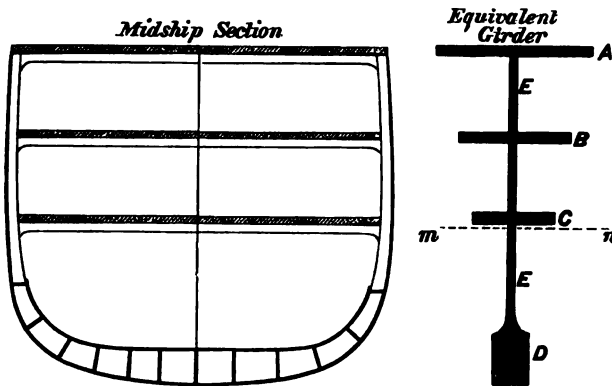
* One of the most singular cases on record is that of the *Chusan* iron steamer, which broke in two outside Ardrossan, a year or two ago, one part of the vessel floating into the harbour, while the other sunk outside. It is only proper to add that this ship was not built for sea-going service, being designed for

the shallow waters of China. Her length was 300 feet, beam 50 feet, and depth in hold only 11 feet. Another case in point is that of the *Mary*, which broke in two in the Bay of Biscay; she was also a shallow-draught vessel of great length.

Chief among these may be mentioned the skin planking or plating on the outside of the ship; the planking or plating on the decks; and the longitudinal frames, keelsons, shelf-pieces under beams, water-ways, side-stringers, and diagonal iron riders. For any transverse section of the ship, the enumeration of all these parts and the estimate of their respective sectional areas are very simple processes, upon which the calculation of the strength of the ship at that section is based.

The greatest bending strains being experienced at or near the midship section, let it be assumed for purposes of illus-

FIG. 99.



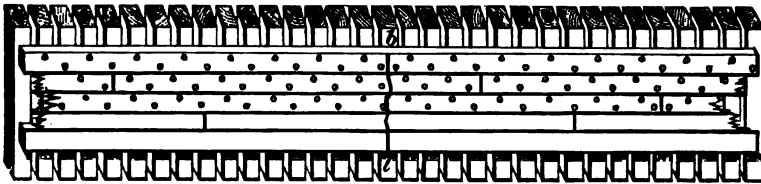
tration that the ship is upright, and that it is desired to ascertain the strength of the midship section against cross-breaking strains. In performing this calculation, it is usual to construct an "equivalent girder" section, similar to that shown in Fig. 99. On the left is drawn an outline of the midship section of an iron ship with a double bottom, and with longitudinal frames between the outer and inner skins, these latter being indicated by the strong black lines. On the decks, the planking, plating, and stringers will also be distinguished from the transverse beams upon which they are supported. The *effective areas* of all these pieces which cross the

midship section, and extend to some distance before and abaft it, are represented in the "equivalent girder" on the right. The deck planking and plating on the upper deck are concentrated in the flange A; those of the middle deck in the flange B, and those of the lower deck in the flange C. The inner and outer bottom plating, longitudinal frames, &c. from the turn of the bilge downwards are concentrated in the lowest flange or bulb D; the vertical or nearly vertical plating on the sides, together with the longitudinal stiffeners worked upon it, form the vertical web EE, connecting the flanges. It will be observed that the depths of the girder and midship section are identical, and all the corresponding pieces in both are situated at the same heights, the vertical distribution of the pieces on the midship section being maintained in the girder.

There are many important matters connected with the work of constructing equivalent girders; but one or two only of the most important can be mentioned. First, it is necessary to distinguish between the *total* sectional areas of the longitudinal pieces on the midship section, and their *effective* areas which are shown on the girder. A very simple illustration will show the character of this distinction. In wood ships it is usual to arrange the "butts" of the outside planking so that at least three planks intervene between consecutive butts lying on the same transverse section. Fig. 100 shows this arrangement; *b* and *l* are two butts placed on the same timber; and the probable line of fracture of the planking between these butts is indicated. Against tensile strains tending to pull the butts open on any section such as *H*, the butted strakes have little or no strength; therefore, in order to allow for this weakening on the midship section, *one-fourth* of the total sectional area of the outer planking must be deducted. Further, there must be bolts or wooden treenails driven in the unbutted planks, to secure them to the ribs of the ship; and the holes cut for these fastenings at any cross-section may be taken as equivalent

to a further loss of about *one-eighth* of the total sectional area. Putting together the allowances for bolts and fastenings, it appears therefore that the *effective* sectional area of planking thus arranged is about *five-eighths* of the total sectional area when resistance to *tensile* strains is being considered. But when *compressive* strains have to be resisted, the conditions are different. If the butts are properly fitted and caulked, the butted strakes are nearly, if not quite, as efficient as the unbutted strakes; and if the bolts and treenails properly fit their holes, no deduction need be made for these holes. Hence, against compressive strains, the effective area practically equals the total sectional area. Similarly, in iron ships, the holes for the rivets securing the outer plating to the ribs cut

FIG 100.



away about one-seventh or one-eighth of the total sectional area; and this deduction must be made from the total area in order to find the area effective against tensile strains; whereas against compressive strains no such deduction is needed. In many other instances similar allowances are required; but the process is an easy one when the details of the construction of a ship are known.

Another important matter is the determination of the relative values of wood and iron, or wood and steel, when they act together in resisting longitudinal bending. So long as the strains put upon the materials do not surpass the limits of elasticity of the wood—a condition which is fulfilled in nearly all cases—it is a fact, ascertained by experiment, that the wood will act with the metals and lend them valuable assistance. This is very advan-

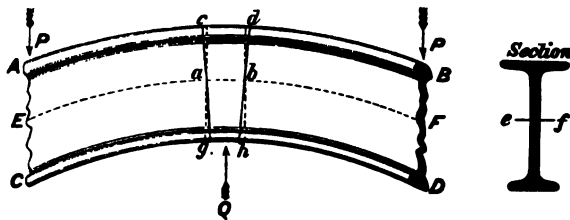
tageous to the structural strength of ships of all classes, in which iron stringers or ties are used on the decks and elsewhere, with wood planking over them. In composite ships also, with a wood skin worked on iron ribs, or in sheathed iron ships, wherein wood planks are worked outside the iron plating in order to receive zinc or copper sheathing, this combined action of wood and iron is of great value. The late Professor Rankine suggested some years ago that a fair allowance, averaging the various strengths of the timbers used in shipbuilding, would be to consider wood equivalent to *one-sixteenth* of its sectional area of iron; and this is the allowance usually made in determining the effective sectional areas for the portions of the deck-flanges (A, B, C, in Fig. 99), representing the wood planking, or for other parts where iron and wood act together.

When the equivalent girder has been drawn, the next step is to estimate the strength of the midship section thereby represented; and this is done exactly in the same manner as if the girder were the cross-section of a long beam, subjected to the same bending strains as those to which the ship is subject. The comparison of a ship tending to hog or sag to a beam is a very old one, having been made by some of the earliest writers on the theory of naval architecture. Like many other suggestions, this was not made use of to any great extent until the introduction of iron shipbuilding; and the late Sir William Fairbairn did much towards establishing the practice of treating a ship as a hollow girder, so far as longitudinal bending is concerned. Readers familiar with mathematical investigations of the strength of beams will not require any further explanation respecting the use made of the equivalent girder; but there may be some not acquainted with these investigations, and to assist such in understanding the conclusions stated farther on, a brief explanation will be given of the principal steps by which the strength of a beam may be calculated.

Fig. 101 shows the side view and section of a flanged

beam, which is bent by the action of the downward pressures P, P and the upward pressure Q . When it is thus bent, the convex upper side AB must have become elongated, as compared with its length when the beam was straight; whereas the concave under side CD must have been shortened. Hence at some intermediate part—suppose at EF —there will be found a surface which is neither stretched nor compressed, but maintains the same length which it had when the beam was straight. The surface EF is termed the “neutral surface;” all parts of the beam lying above it are subject to tensile strain, all parts below are subject to compressive strain. In the sectional drawing of the beam, ef corresponds to EF , and is termed the

FIG. 101.



neutral axis of the cross-section. On the neutral surface EF , let any two points ab be taken. When the beam is bent, the corresponding length on the upper surface is shown by cd , and that on the lower surface by gh ; the figure $cghd$ therefore represents the shape into which the bending of the beam distorts that part which was of the uniform breadth ab throughout the depth of the beam, before it was bent. For any layer in the beam the elongation or compression produced by the bending varies directly as the distance of that layer from the neutral surface. Within the limits of elasticity of the material, the elongation or compression also varies directly as the strain applied; that is to say, a bar of the material will stretch *twice* as much with a given weight suspended to it as it does with half that weight suspended; and so on. Hence it will be seen that

in a bent beam the stress on each unit of sectional area in a cross-section such as that in Fig. 101, or any other form of section, varies directly with the distance of that unit from the neutral axis *ef*. At the upper surface AB the stress will be twice as severe as it is midway between AB and EF, and the tensile strain at AB bears to the compressive strain at CD the same ratio as the distance of AB from EF bears to the distance of CD from that surface.

The question thus becomes important, What governs the position of the neutral axis? The answer is very simple. It is coincident with the *centre of gravity* of the cross-section of the beam, supposing (as may fairly be done) that the external forces PPQ act perpendicularly to the surface EF. This follows directly from the consideration that the sum of all the tensile forces developed on any cross-section of the beam must equal the sum of the compressive forces. The neutral surface of the beam contains the centres of gravity of all the cross-sections; and this condition holds for all forms of cross-section, and all variations in form at different parts of the length; the preceding remarks containing no assumption that the beam is of uniform cross-section throughout its length. When the form of the cross-section of any beam is given, the above stated property enables the position of the neutral axis to be determined easily.

One further step remains to be explained. At any cross-section of the beam in Fig 101 (say, at the middle of the length) the external forces (P and Q) give rise to a bending moment the value of which is easily ascertained. The effect of this moment is seen in the curvature of the beam; but it may be asked by what moment is the moment of the external forces balanced. Obviously it must be balanced by the moment of the internal forces (*stresses*, as they have been termed) developed by the elongations and compressions; each of these stresses may be considered as a force acting perpendicularly to the plane of the cross-section, and having for its fulcrum the neutral axis. And in this resistance to the external forces the internal forces all co-

operate—both tensile and compressive—from top to bottom of the beam. The total moment of these internal forces is readily found for a given form of cross-section. Since—

The stress per unit of sectional area varies with the distance from the neutral axis,

The moment of stress about the neutral axis must vary with the *square* of the distance of the unit of area from the neutral axis.

The total moment of the internal stresses may therefore be expressed in the form,

Moment = a constant quantity \times area of cross-section \times square of depth of section.

If each element of area is multiplied by the square of its distance from the neutral axis, the sum of the products is termed the *moment of inertia* of the cross-section about the neutral axis; and hence it is usual to write,

Moment of resistance to bending } = K \times moment of inertia
of internal stresses } of cross-section,

where K is a quantity dependent upon the elasticity of the material of which the beam is made.

From these general expressions a few practical deductions may be drawn. First: it will be seen that, for beams of similar cross-sectional form, the strength varies as the product of the *square* of the depth by the sectional area, supposing the beams to be formed of the same material. Second: it will be obvious that, with the same sectional area, changes in the form of the cross-sections of beams may largely influence the moment of inertia, and therefore influence the strength. Third: the great advantage of the *flanged* form of beam shown in Fig. 101 will be apparent; for the material thrown into the flanges is at a considerable distance from the neutral axis, and the moment of inertia is consequently increased. So long as the vertical web retains sufficient strength to keep the flanges at their

proper distance apart, and to efficiently connect them, it is desirable that all the rest of the available material should be thrown into flanges; and in lattice girder beams and bridges the principle is carried to an extreme.

Reverting to the equivalent girder for a ship (Fig. 99), it is possible to make use of the foregoing general principles in order to compare the relative importance of different parts of the structure, as measured by their resistance to longitudinal bending. The most important parts are the upper flange A and the lower D; the flange C, corresponding to the lower deck, lies so close to the neutral axis (MN) as to be of little assistance. The flange B is of much more service, but cannot compare in importance with A. The web EE, formed by the side plating or planking, is mainly useful, when the vessel is upright, in forming a rigid connection between the flanges and enabling them to act together; but on account of their distance from the neutral axis, the parts of EE lying nearest to A and D offer considerable resistance to bending. When the vessel is inclined, the conditions are somewhat changed; she then resembles a hollow girder set angle-wise. The parts contributing most to the longitudinal strength will then be the upper deck, the sheer-strakes and side plating adjacent to that deck, and the bottom in the region of the bilges; but the arrangements which are efficient when the vessel is upright will also contribute greatly to the efficiency when she is heeled over to the most considerable angles likely to be reached in rolling. Vessels are sometimes thrown over on to their beam ends, but this is a very exceptional position, and need not have much influence upon the distribution of the material. There is good reason to believe that a ship which is strong enough to resist longitudinal bending moments when she is upright will be sufficiently strong in every other position. By general consent, therefore, the upright position is assumed in the construction of the equivalent girder, and most care is

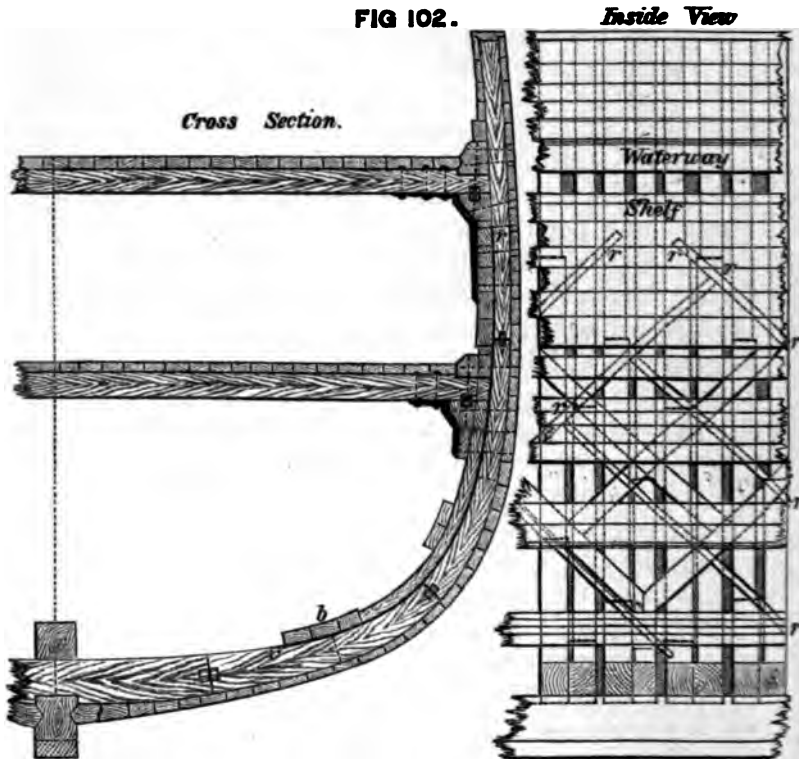
bestowed to meet the bending strains incidental to that position.

Hogging, it will be remembered, is the change of form produced by the ends of a ship dropping relatively to the middle, the keel becoming arched upwards. The conditions of strain are then similar to those in the beam, Fig. 101; the upper parts of the structure being subjected to tensile strains, the lower to compressive strains, and the division between the two being marked by a neutral surface. Sagging is the converse case where the middle drops relatively to the ends; the keel becoming arched downwards, the upper parts of the structure being subjected to compressive strains, and the lower to tensile strains, the change of strain being marked by a neutral surface, not agreeing in position with that for hogging. It will indeed be evident, from what has already been said respecting the difference between the total and effective sectional areas of parts of the structure, that the equivalent girder for hogging strains must be different from that for sagging strains; in practice the two are always dealt with independently. But while the sectional areas of the upper and lower flanges A and D of the equivalent girder in Fig. 99 change both their absolute and relative values, according as hogging or sagging strains have to be resisted, it is still true, for both hogging and sagging, that these are the two parts of the structure which are of the greatest assistance in resisting change of form. Their joint action is secured by means of the web formed by the skin.

Taking in order the three parts of the equivalent girder which require most attention, viz. the upper flange A, the lower D, and the web EE, we now propose to sketch very briefly the character of the arrangements by which they are made more or less efficient in different classes of ships. Wood ships, ordinary iron ships, "composite" ships (which resemble ordinary iron ships except in having wooden keels, stems, sternposts, and outside planking), and a few special classes of iron ships, will be mentioned; but it must be understood that no endeavour will be made to describe the

structural details of any class; for these the reader must turn to works on shipbuilding. To illustrate the contrast between these classes, and to assist our explanations, Figs. 102, 103, and 104 have been prepared. The former shows, in cross-section and inside elevation, the construction of a wooden ship according to the former practice of the Royal

FIG 102.



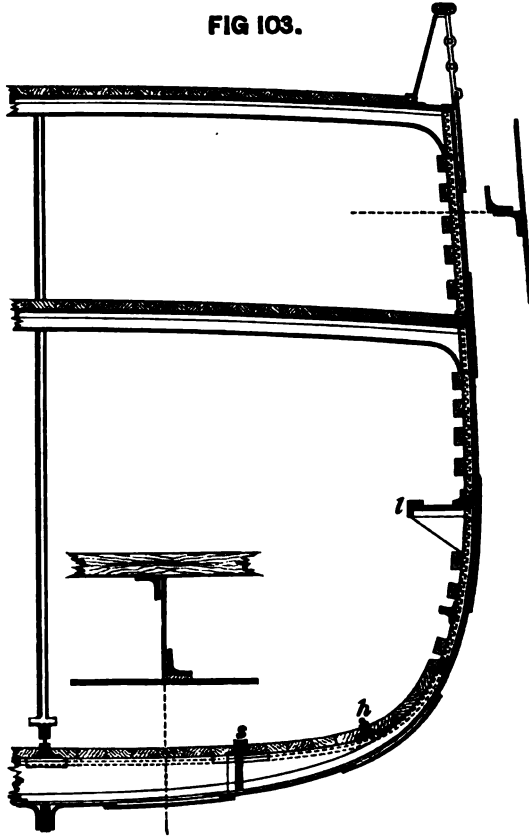
Dockyards. Fig. 103, page 324, shows, in cross-section, the construction of an ordinary iron merchant ship. Fig. 104, page 331, shows, in cross-section, the construction of an ironclad ship of modern type. As we proceed, repeated references will be made to these figures, and their principal features will be noted in connection with the contribution of individual parts to the general structural strength.

First, as to the upper flange in the equivalent girder for a wood ship. The parts ordinarily included are as follows: the deck-planking, allowing for its effective area in the manner explained above; and the thick "water-way" fitted upon the beam ends (see Fig. 102). Such a flange is much less strong against the tensile strains brought upon it by hogging than it is against the compressive strains due to sagging; the effective area against tensile strains being less than three-quarters of that against compressive strains. It is a matter of common experience that, under severe hogging strains, signs of working and weakness display themselves in the upper works of wood ships. Recently, in order to add strength to the upper deck, iron stringers and plating have been worked under the wood planking in many of the wood-built ships of the Royal Navy. Examples of this addition will be found in the converted ironclads of the *Caledonia* class, and in the largest class of corvettes.

In ordinary iron or composite ships the upper flange of the equivalent girder closely resembles that described for recent wood ships. Fig. 103 shows the arrangement; the iron stringer plates on the beam ends being drawn in strong black lines under the wood planking. These stringers should always be strongly secured to the uppermost strake of the side plating of an iron ship (termed the "sheer-strake"), which is often made thicker or doubled, for the purpose of increasing the longitudinal strength. Composite ships also, although they have not an iron skin, are usually fitted with a sheer-strake. At the outset of iron shipbuilding, the use of deck-stringers was not general; but as the sizes of ships increased, the necessity for adding to the longitudinal strength of the upper decks became apparent, and stringers were adopted. The breadths of these stringers have been increased as still larger vessels have been constructed; and at the present time it is very common to find the whole, or a great part, of the surface of the upper and main decks in large iron steam-ships covered with plating. These complete or partial iron or steel decks, fitted under the wood planking,

are most valuable additions to the structural strength, and have corrected weaknesses formerly too common in the upper parts of iron ships. Complete iron and steel upper decks have been fitted, from the first, in the iron-built armoured

FIG 103.



ships of the Royal Navy, and have proved thoroughly efficient. In the *Great Eastern* the exceptional strength required has been provided by a very unusual construction of the upper deck. This is a cellular structure formed by two strong iron skins worked above and below deep girders running longitudinally. Besides the unusually strong plating,

the strength of the girders in this ship therefore comes into play against hogging or sagging strains; whereas the *transverse* beams fitted almost without exception in other ships can lend no assistance to the decks against such strains. In the largest vessels afloat, excepting the *Great Eastern*, the simpler and lighter arrangement of iron or steel decks worked under the planking is, however, found to answer every purpose.

Next, as to the *lower flanges* in the equivalent girders of the different classes of ships; this is a less simple case than the preceding.

In wood ships the parts included in the lower flange vary considerably, according as hogging or sagging strains have to be resisted. The bottom planking up to the bilge, the keel, keelson, and binding strakes (*b*, Fig. 102) are all effective, although not equally effective, against both hogging and sagging strains. It is a common practice to fill in the openings between the ribs, from the keel up to some distance from the bilge; and this has a twofold advantage. In case of damage to the bottom planking the fillings keep the water out of the hold; and, moreover, when the vessel tends to hog, and her bottom is brought under compression, the lower part of the frames is made into a practically solid mass of timber, the fillings offering great resistance to any change of form. When sagging takes place, and the bottom is brought under tension, the fillings can lend no such help to the pieces lying longitudinally, and the difference is very considerable. It is, however, noteworthy that in ordinary wood ships the severest longitudinal bending moments are those tending to produce hogging, a fact which makes the use of fillings of the greater value. To assist the bottom in resisting the tensile strains due to sagging, iron stringers have been fitted in some few cases in lieu of the ordinary thick binding strakes; but this arrangement is not so valuable as the use of iron strengthenings to the upper deck.

In ordinary iron ships the bottom flange of the girder is made up of the keel, keelson, side keelsons (*s*, Fig. 103), hold stringers (*h*), and the bottom plating. These are all effective against both hogging and sagging strains; and, as already explained, the difference in the sectional areas, effective against tension and compression respectively, is not nearly so marked as in the case of the corresponding part of a wood ship. The transverse frames, or ribs, of the iron ship are 20 inches or 2 feet apart, there being nothing corresponding to the fillings of the wood ship. Fig. 103 by no means represents the universal practice of iron shipbuilders as to the arrangement of the longitudinal stiffeners to the bottom plating. There are very many varieties of side keelsons, hold stringers, keelsons, keels, &c., some builders preferring one arrangement, other builders preferring another arrangement. But they have one feature in common. The *main frames* lie transversely like those of a wood ship, and do not contribute to the longitudinal strength, whereas the longitudinal pieces are supplementary or subordinate to the transverse framing, and are either fitted in between the ribs (like *s*), to secure a direct connection with the bottom plating, or over-ride the ribs (lik *h*, Fig. 103). This is a grave defect in the ordinary mode of framing iron ships; economy of weight in proportion to strength would be better secured if the main frames were placed longitudinally, and thus made to assist the skin against the principal bending strains.

For wood ships it is practically a necessity to place the ribs transversely, and in the earliest iron ships the arrangements of wood ships were naturally imitated to a considerable extent. The moderate size of the earlier iron vessels rendered almost unnecessary any longitudinal strengthenings to the bottom other than were furnished by the engine and boiler bearers, fitted primarily as supports to the propelling apparatus. But as the sizes of ships increased, the longitudinal strengthenings to the bottom were multiplied, and in some cases the bottom was thus strengthened, while

the top flange of the girder was left almost uncared for, the result being a great disproportion between the strength of the top and bottom flanges. There are, of course, many local strains to be borne by the bottom of a ship—such as those due to grounding, the carriage of cargo, and possible concentration of weights—which are not paralleled by any strains that have to be borne by the decks; but to give greatly disproportionate strength to either flange involves a bad distribution of the material. The recent use of iron upper decks and broader stringer plates has partially corrected an evil formerly prevalent in iron merchant ships, but the upper flange is still commonly made much weaker than the lower. If ships fail, they usually yield to hogging strains; as an example of the opposite fault, where the upper flange of the equivalent girder yielded to the compressive strains incidental to sagging, we may refer to the case of the shallow-draught steam-ship *Mary*, which is alleged to have foundered in consequence of the upper deck crushing up when she met with very heavy weather in the Bay of Biscay on her passage to the station for which she was designed.

There is no dispute but that the combination of strength with lightness would be more efficiently secured if the main frames of iron ships were made longitudinal instead of transverse. The continued use of the old system of framing is mainly due to the greater cheapness of construction, rendered possible in consequence of the familiarity of the workmen with this mode of building, and the greater rapidity with which the work can be carried on. Moreover, by fitting numerous intercostal side keelsons, hold-stringers, &c. sufficient longitudinal strength can undoubtedly be given to the bottoms of even the largest ocean steamers, 400 to 500 feet in length, and the additional weight involved is not thought of so much importance as to render it desirable to incur the greater cost of construction of the longitudinal system of framing. To what extent weight might be saved on the hull and added to the carrying power by adopting longi-

tudinal frames will appear from the following example, given by Mr. Reed.* On a mail steamer of 2700 tons burden it was found that, by making the transverse framing subordinate to the longitudinal, a saving of no less than 150 tons could be effected in the weight of the hull, with an actual increase in the longitudinal strength, and no fear of insufficient transverse strength. Such a saving, as already explained,† really constitutes an addition to the carrying power of the ship, and can be made available either for remunerative cargo or for carrying increased weights of armour or armament. Many similar examples, drawn from actual practice, might be given, but they are scarcely needed to enforce a truth that must be nearly self-evident. If the dimensions of ships continue to increase, and steel takes the place of iron, there will be the greater probability of the general adoption of longitudinal instead of transverse framing. But at present the advantages in rapidity and cheapness of construction suffice to maintain the old system in use throughout the mercantile marine.

Composite ships resemble ordinary iron ships in having the main frames transverse; and the bottom flanges of their equivalent girders differ from those of the iron ships chiefly in that they include wood keels and bottom planking. The latter especially loses, as compared with iron plating, in its resistance to the tensile strains due to sagging moments. No equally intimate connection can be made between the intercostal side keelsons of a composite vessel and the bottom planking, as are possible between such keelsons and the bottom plating of an iron ship. Nor can the composite ship have the help of fillings between the frames like those of a wood ship. These are the only points of difference that need be mentioned.

Although the transverse system of framing is so generally adopted in the mercantile marine, there are not a few ships in which longitudinal framing occupies the chief place.

* See page 84 of *Naval Science* for 1872.

† See Chapter I. page 3.

The *Great Eastern* is the most notable example, and her structural arrangements, due to the joint labours of the late Mr. I. K. Brunel and Mr. Scott Russell, furnish good evidence of the superiority of the longitudinal system.* Other and much smaller merchant ships have been built on very similar principles; and in all the iron-built ironclads of the Royal Navy great prominence is given to longitudinal framing. Such framing is of the greatest advantage in the lower parts of ships lying below the lower deck. The comparatively flat surfaces of the bottom plating below the bilge are best stiffened against buckling by longitudinal frames, which form strong girders well secured to the bottom plating, and contribute a very substantial addition to the lower flange of the equivalent girder for the upright position. At the bilge there is usually considerable transverse curvature in the bottom plating, a fact which gives it great stiffness in itself against buckling under compressive strains, due either to hogging moments or to the concentration of surplus buoyancy; hence immediately at the bilge longitudinal frames are not so much required for the purpose of preventing buckling. Very frequently external bilge-keels are fitted just at this part of the bottom, forming good stiffeners to the plating, besides adding their own sectional areas to the lower flange of the girder. Above the bilge, and below the lower deck, longitudinal frames are again of great use, especially in adding to the longitudinal strength when the ship occupies an inclined position, and is subject to hogging or sagging moments. When we reach the parts lying above the lower deck, other considerations enter and make the longitudinals of less importance; in fact, the decks themselves with their stringers, &c. form most

* For much interesting information concerning the construction of this ship, and her predecessors, the *Great Western* and *Great Britain*, see the life of Mr. Brunel, published by his son. It is evident from the

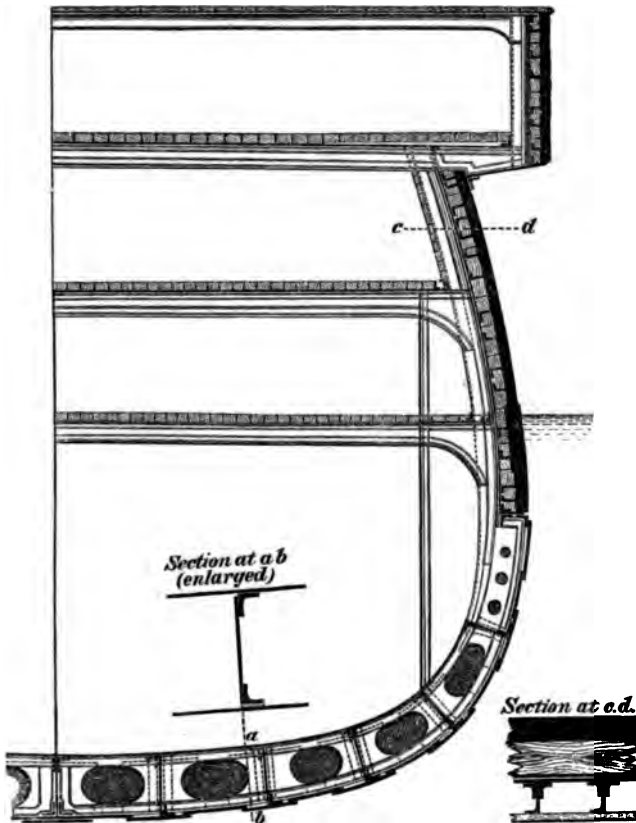
details therein given that, at a very early period after the introduction of iron ships, Mr. Brunel perceived the great advantages attaching to longitudinal framing.

efficient longitudinal stiffeners, and they are usually so close together as to render intermediate longitudinals unnecessary. Sometimes, where a lower deck does not extend throughout the whole length, but is broken for some reason, its stringer plate is continued in order to form a stiffener, as shown by *l*, Fig. 103. It may, however, be regarded as the rule that the decks need no aid of this kind, and that the only framing required in the upper parts of ships is vertical and transverse. Such framing stiffens most efficiently the almost upright side plating, gives facilities for attaching the beams to the side, and answers other purposes. The extent to which it is adopted must of course depend upon the special conditions of each class of ship. Widely spaced vertical frames suffice in the upper parts of the *Great Eastern*; whereas in armoured ships these frames are very closely spaced, in order to assist in strengthening the target formed by the armoured side. Fig. 104 illustrates the last mentioned case; below the armour, the main frames are longitudinal, as shown; but behind the armour the principal frames are vertical, being spaced only 2 feet apart (see the section at *cd*). The longitudinal girders worked between the strakes of the wood backing are not fitted primarily with a view to increase the longitudinal strength of the structure, although they have this effect, but are intended to increase the resistance of the target formed by the side of the ship against penetration or damage by projectiles.

Looking a little more closely into the arrangements illustrated in Fig. 104, it will be evident that the lower flange of its equivalent girder must be much stronger than that of the ordinary iron ship illustrated by Fig. 103. The longitudinal frames of the ironclad are numerous and strong, as compared with the longitudinal strengthenings of the merchant ship. These frames, as already explained, are of great value in preventing buckling, and resisting the tensile strains due to sagging, even when there is only a single outer skin. But their efficiency in these respects

and the strength of the lower flange of the girder are both very greatly increased by the adoption of the inner skin plating, forming a double bottom. This cellular construction is shown by experiment to develop most efficiently the

FIG 104.



strength of a structure formed of wrought-iron plates and bars, any one of which, taken singly, has little strength to resist bending. It is unnecessary to repeat what has already been said respecting the gain in safety due to the use of double bottoms, this being so great that, even if there were

no gain in structural strength, the shipbuilder would be fully justified in adopting the arrangement.

Cellular double bottoms require the sacrifice of some of the hold space, and this is an objection, from a commercial point of view, to their use in merchant ships, where the cargo-carrying capacity is of very considerable importance. Partial double bottoms, extending from the bilges to the keel, are, however, frequently fitted, chiefly for the purpose of holding water ballast, but the inner skins and longitudinal keelsons often fitted in these tanks add considerably to the longitudinal strength. Some of the earlier ironclads of the Royal Navy are similarly circumstanced, having only partial double bottoms; but the general practice has been for many years to fit complete double bottoms, as in Fig. 104. It has already been explained * that the double bottom does not extend throughout the whole length of the ships, but usually leaves about one-sixth of the length at either end destitute of this strengthener and protection. While the safety of the ship at the extremities is provided for by the other means previously described, her strength at any cross-section outside the double bottom is much lessened by the absence of the inner skin. It is, however, to be observed that the strains to which these parts are subjected are much less severe than those borne by sections lying farther from the extremities, so that in proportion to these strains the strength is ample.

Thirdly, attention must be directed to the webs or vertical portions of the equivalent girders for different classes of ships.

In ordinary wood ships the outside planking, as well as that inside, is worked (as shown in Figs. 100 and 102) in one thickness, and made up of comparatively narrow planks, or "strakes," the butts and edge-seams of which are caulked. This planking, with the shelf-pieces under the

* See Figs. 18-25, page 30.

beams, and the diagonal strengtheners, form the web of the girder. The ultimate strength of these parts against cross-breaking strains is no doubt ample in all or nearly all cases; and what has to be regarded is rather their strength to resist the *racking* strains which always accompany bending.

Reverting to the case of the beam in Fig. 101, it will be seen that, although the total of the tensile forces experienced by any cross-section equals the total of the compressive forces, these two resultants act in opposite directions, and therefore tend to *rack* or distort the beam, this racking strain reaching its maximum at the neutral surface, and gradually decreasing to nothing at the top and bottom of the beam. So long as the beam is in one piece, or so long as the pieces forming its web are well connected together edgewise, there is no difficulty in meeting this racking strain. But if a beam were constructed of which the web consisted of strakes or narrow planks placed edge on edge, and having little connection edgewise, then obviously, as the beam bent, these planks would be made to slide upon one another by the racking strains. And if these strakes were crossed at right angles by ties, corresponding to the ribs or timbers of a wood ship, these ties would add little to the strength of the web against racking. For (to quote the well-known illustration of Sir Robert Seppings), if a field-gate be made of pieces, all lying parallel or at right angles to one another, its resistance to distortion of form will be very small. On the contrary, if the strakes forming the web are crossed by diagonal ties—corresponding to the cross-bar of the gate—there will be a great addition to the strength of the combination against racking and distortion of form.

Such are the simple principles upon which the use of diagonal “riders” or ties in wood ships is principally based. The side planking above the bilge has in itself little strength to resist racking strains; and in many cases these strains have been so severe as to show marked evidence of their

action. When the line-of-battle ship *Cæsar* stopped on the launching ways and broke considerably, it was in the planking near the middle of her depth that working was most apparent; the diagonal riders also showed signs of severe straining. Moreover, it is a matter of common observation that, when the caulking of the seams of planking in a wood ship becomes slack and needs renewal, she is much more liable to working in the longitudinal sense. This circumstance is easily explainable, seeing that, when well caulked, there is a much greater resistance to the relative motion of the planks which racking strains tend to produce. Diagonal riders furnish, however, the best corrective for this source of weakness, if a single thickness of planking is worked.*

When first introduced into the Royal Navy by Sir Robert Seppings, early in the present century, these riders consisted of massive timbers, worked inside the transverse ribs of the ship. But for many years past iron-plate riders have been substituted for the timber riders, and with very great advantage. In Fig. 102 these riders are indicated in both the cross-section and the inside view, being marked *r, r*. It will be observed that they are worked *inside* the ribs, and inclined 45 degrees to the vertical. Wood-built merchant ships are usually furnished with similar iron riders, which are often worked *outside* the timbers; and that arrangement has some advantages in point of strength, although it is not so convenient to execute during the construction of a ship. Whether fitted inside or outside, the riders are usually inclined so that their upper ends slope towards the midship section of the ship; near the middle of the length (as shown on the inside view, Fig. 102) the two systems of riders belonging to the fore and after bodies respectively are made to cross each other at right

* In some small vessels built by the late Mr. Ditchburn, bolts were driven edgewise through adjacent strakes of the skin planking, in order

to prevent racking. A similar plan of bolting is sometimes adopted in certain portions of the bottom planking of ordinary wood ships.

angles. In some cases where special strength is desired, this duplicate arrangement of the riders is carried right fore and aft, as in her Majesty's ship *Caledonia*; but the more common plan is to have one system only. It will be observed that, as usually arranged, these iron riders are very efficient aids against hogging strains; which are those most injurious to wood ships. When hogging takes place, the ends must drop relatively to the middle, a change of form which would bring the iron riders under tensile strains, the kind of strains which they are best fitted to resist. Against compressive strains these thin narrow bands of iron cannot be nearly so efficient as against tensile strains, so that, as commonly fitted, riders are not of much service against sagging strains, except amidships, where the two systems overlap one another. Of course it is amidships that the severest strains are experienced, so that the crossing of the riders there is a great advantage; and it has been suggested that, if the duplication of the systems were carried through, say, one-third or one-half of the length amidships, there would be a further gain in strength, owing to the circumstance that the riders would then assist against sagging as well as hogging.

Composite ships of the mercantile marine are usually built with a single thickness of planking, and consequently need diagonal strengtheners. One common plan of fitting these is to have rider plates riveted outside the iron frames, and inclined 45 degrees to the vertical. The upper ends of those riders are attached to the sheer strake, and the lower to another detached longitudinal tie, formed by a strake of plating worked at the bilge.

The composite ships of the Royal Navy are built with their outside planking in two thicknesses. The edge-seams of the planks in the inner thickness are each covered by a plank of the outer thickness; the seams of the outer thickness being similarly covered by the planks of the inner thickness. A strong edgewise connection is thus made in the double skin, and consequently diagonal rider

plates are dispensed with. It should be added that this plan of working the planking in two layers is principally adopted because these vessels have their bottoms covered with copper sheathing, and any injurious galvanic action of the copper on the iron hull can thus be avoided.

Other composite ships have been constructed with the outside planking in two thicknesses, one or both of which had the planks worked diagonally; it was then unnecessary to fit diagonal rider plates to assist the skin against racking strains.

This diagonal system of planking has also been adopted in some special classes of wood ships with great success. The royal yachts are examples of this system of construction, and Mr. White, of Cowes, has applied it in many vessels built at his yard. Three thicknesses of planking are employed, the two inside being worked diagonally, and the outer one longitudinally. The two diagonal layers are inclined in opposite directions, and the skin thus formed possesses such superior strength to the skin of an ordinary wood ship that there need be comparatively little transverse framing above the bilges. Direct experiments with models, and the experience gained with ships built on this plan, have demonstrated its great superiority in the combination of strength with lightness. The royal yacht *Victoria and Albert*, built on this plan, with her unusually powerful engines and high speed, is subjected to excessively great sagging moments,* but has continued on service for twenty years with complete exemption from signs of weakness. Like many other improved systems of construction, this is found rather more expensive than the common plan; but if wood had not been largely superseded by iron, probably much more extensive use would have been made of the diagonal system.

It may be mentioned that the large steam and sailing launches employed in the Royal Navy are built on a some-

* See the remarks at page 278.

what similar plan; the skin planking is in two thicknesses, worked diagonally, with the two layers inclined in opposite directions. These boats answer admirably, and have only frames on the flat of the floor, where the wear and tear of grounding have to be borne.

Iron ships have outer skins formed by numerous plates, each of which is strongly fastened at the edges, as well as the butts, to the plates adjacent thereto. Such a combination is very strong against longitudinal racking strains, and needs no supplementary strengthening such as the diagonal riders of wood or composite ships. Many proposals have been made, and several plans have been patented for using diagonal strengthenings in iron ships, the superiority of an iron skin, and its capability of resisting and transmitting strains in all directions, not having been apprehended. From the bilges upwards, the outside plating forms the principal part of the web of the equivalent girder section in ordinary iron ships like that in Fig. 103; and when properly stiffened, it acts this part most efficiently when the ship is upright. When she is considerably inclined, some parts of the same plating contribute strength to the flanges of the girder-section for that position, as already explained. Vessels with double bottoms extending far up the side, or with wing-passage bulkheads like that in Fig. 104, gain much on vessels with single bottoms, since the additional skin contributes to the strength of the web of the girder for the upright position, and to the strength of the flanges of the girders for inclined positions. Any other longitudinal bulkheads which extend over a considerable length in the ship may also be regarded as contributing to the longitudinal strength, and one of the most valuable additions of this kind that can be made to a ship is a middle-line bulkhead like that shown in Figs. 18-25 (page 30) for an ironclad of recent type. The longitudinal bulkheads fitted in the *Great Eastern* add greatly to her longitudinal strength. It need hardly be said, however, that such bulkheads are fitted primarily with a view to increase in safety

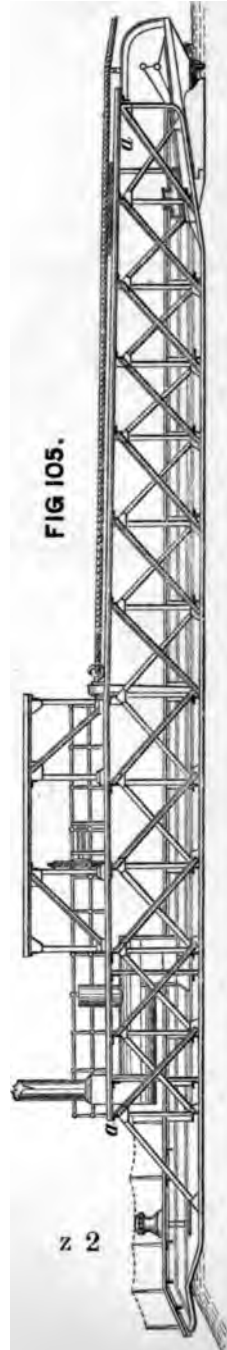
or accommodation; the increase in structural strength being a secondary consideration.

Mention may also be made, in passing, of a plan upon which a few iron ships have been built, intermediate in character between ships with transverse frames and others with longitudinal frames. The main frames in these special vessels lie diagonally, somewhat after the fashion of riders, and therefore cross the probable line of fracture of the plating in ordinary iron ships, which line, it has been said, would lie in a transverse plane. It is hoped, therefore, either to divert the line of fracture from this transverse plane to some longer and stronger diagonal line or else to make the diagonal frames add to the strength of the transverse section which gives the smallest effective sectional area to the bottom plating. The plan has not found favour with shipbuilders, nor does it seem comparable to the longitudinal system, either in cheapness and simplicity of construction or the combination of lightness with strength.

Vessels designed for service in shallow waters often have their hulls strengthened longitudinally by girders. It has been shown that the *depth* of any cross-section of a vessel has a great influence upon the amount of its resistance to bending strains; and in these special vessels the depths of the hulls are so small as to render supplementary strengthenings essential. The American river steamers before mentioned furnish good examples. Their hulls are extremely shallow, and have to carry an enormous superstructure of saloons, &c., although they have in themselves little longitudinal strength. To supply this, what is termed a "hog frame" is constructed. It consists of a strong side keelson fitted along the flat floor of the vessel, at some distance out from the keel. Upon this keelson are erected a series of timber pillars, and along over the heads of the pillars a strong continuous timber beam or tie is carried, diagonal struts being fitted between it and the keelson. A light but strong timber girder of considerable depth is thus

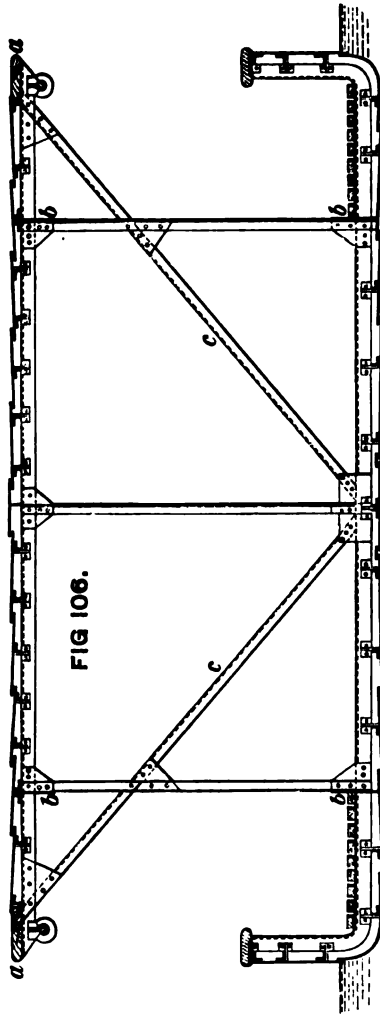
firmly combined with the shallow hull, and made to help it efficiently against hogging.* In other light-draught vessels built for river or coast service, with iron or steel hulls, arrangements have been adopted similar in principle to the foregoing, iron or steel lattice girders having been substituted for the more cumbrous and less efficient hog frame. These vessels, being designed for smooth-water service, are not subjected to longitudinal strains of so severe a character as those experienced by ships at sea, and, what is still more important, their strains remain nearly constant in character as well as intensity. Hence their case is much more easily dealt with in the manner described, than is that of a sea-going ship which has to bear rapid and extreme variations of longitudinal bending strains while she rolls from side to side in a sea-way. At the same time, there is considerable range for the exercise of ingenuity in securing the lightness of construction demanded by the shallow draught. The conditions of the problem resemble more closely those of bridge construction than those connected with the construction of sea-going ships, with which we are more especially concerned.

Figs. 105 and 106 furnish illustrations of this class; being respectively a side view and cross-section of a tug-boat built



* See a very interesting paper on the subject by Mr. Norman Russell, in vol. ii. of the *Transactions* of the Institution of Naval Architects.

for the Godavery river from the designs of Mr. J. R. Napier, about eight years ago.*



The draught of water was not to exceed one foot; it was consequently necessary to make the structure as light as possible, and steel was used instead of iron. The hull proper is that of a shallow open boat, about $3\frac{1}{2}$ feet deep; it is formed, as shown in Fig. 106, of steel plates $\frac{1}{8}$ inch thick, with each strake of plating stiffened by a longitudinal angle-bar. The transverse frames consist of angle-bars, spaced 9 feet apart, and therefore quite subordinated to the longitudinal frames. The hull proper, being so shallow and without a deck, could not contribute the necessary longitudinal strength; but this is obtained in a very ingenious manner. An awning was necessary to furnish protection from a vertical sun and tropical rains; it is marked

a, a in the diagrams, and is about 10 feet above the bottom.

* The drawings and particulars are taken from vol. viii. of the *Transactions* of the Institution of Naval Architects.

To convert this into an efficient upper flange, it is formed of steel plates $\frac{1}{8}$ inch thick, each strake being stiffened by a longitudinal angle-bar. Transverse angle-bars are fitted, 9 feet apart, vertically over the corresponding transverse frames of the hull, and diagonal braces (*c, c*, Fig. 106) connect the corresponding transverse stiffeners to hull and awning, preventing the latter from being pulled or blown over. Lattice girders (*b, b*, Fig. 106) formed by diagonal and vertical bars, as shown in Fig. 105, are fitted on each side to strengthen the connection between the awning and the hull, and to enable them to act together in resisting longitudinal bending. The diagrams explain further particulars. The vessels are driven by paddles placed under the sloping stern; the boiler is placed at the bow, where there is also a steam capstan; and the tow-rope is secured near the middle of the length and led along over the awning.

Reverting to the general discussion of the principles which should govern the distribution of the material in order to secure sufficient longitudinal strength at any cross-section of a ship, it will be obvious that, if ships always remained upright, it would be advantageous to decrease the amount of material near the neutral axis of the equivalent girder. This could best be done by thinning the skin plating or planking at this part, and in ordinary iron merchant ships some slight reductions in thickness are often made. It must not be forgotten, however, that inclined positions will be occupied by ships which are subjected to longitudinal bending moments, and then plating which forms part of the web for the girder in the upright position may form part of the flange, and be capable of yielding great assistance to the structure. Hence it is not uncommon to find that, after fitting a few thick strakes of plating from the keel outwards to the bilges, where the severe local strains due to grounding are principally felt, the rest of the bottom plating is made of uniform thickness up to the sheer strake,

which is made thicker for reasons previously assigned. Wood ships usually have their *thickest* planking in the neighbourhood of the middle of the depth, where it can be least effective against longitudinal bending strains when the ship is upright; but these wales are probably the outgrowth of the rubbing strakes formerly fitted near the main breadth, and they also form strong ties above and below the lines of ports in many classes of wooden war-ships, thus restoring, to some extent, the loss of strength due to the want of continuous longitudinal planking in wake of the ports. Moreover, when vessels approach the "beam-end" position, the wales are of considerable assistance in resisting longitudinal bending.

Modern war-ships have their structural arrangements very much controlled by the necessity for protecting certain parts by armour. The general considerations based upon the comparison of a ship to a girder are therefore, to a large extent, overruled, material being massed in flanges formed by decks near the middle of the depth, or thrown into the centre of the web of the girder for the upright position, instead of being added to the upper part or to the upper deck. For instance, to increase the resisting power of the target formed by the armoured side, the skin-plating behind the armour is made about twice as thick as the bottom plating, although its situation is not very favourable to its efficient contribution of longitudinal strength. Nor, to give one other example, do the strongly plated decks fitted some 5 or 6 feet above water (as in the belted ships) or an equal distance below water (as in the central-citadel type) contribute to the longitudinal strength at all to the same extent as the same weight of iron differently distributed might do. The armour plating itself also, even when arranged and fastened with the utmost care, must be regarded rather as a load carried by the structure than as adding much to the longitudinal strength. Being attached to the upper part of the ship, the armour is subjected to tensile strains when hogging moments act upon the structure. Against such

strains it is certain that the armour, as usually fastened, can only develop a small portion of its full strength, the fastenings which secure it to the hull not being of such a character as to render this possible. On the contrary, when sagging moments are experienced, the armour plates, being carefully fitted at the butts, can offer very great resistance to compression, and render valuable assistance to the hull proper. Other means might be found of connecting the butts of armour plates and increasing their resistance to tensile strains; but hitherto it has not been thought necessary to make the attempt. Hence it is customary, in calculations for the strengths of equivalent girders for ironclad ships, to consider side armour as efficient only against compressive strains, and not to take any credit for the help it may render against tensile strains due to hogging moments. This is an omission on the side of safety, and in all questions connected with the strength of a structure exposed to such great and rapidly varying strains as those experienced by ships, a good margin of safety is desirable.

The severest hogging and sagging moments, corresponding to exceptional positions of support for ships afloat or ashore, have been shown to have their maxima at cross-sections lying at or near the middle of the length. Other cross-sections are subjected to bending moments decreasing in amount as the distance from the midship section increases, and finally at the extremities the zero of moment is reached. This diminution of the bending moments from the middle of a ship towards her ends would, if she were regarded as a whole, render possible some diminution in the strength of other cross-sections as compared with the strength of the midship section. And although local strains and other considerations interfere somewhat with the application of the general principle, it still remains true that the fullest association of lightness with strength requires that the shipbuilder shall bestow attention upon the *longitudinal* as well as the vertical distribution of the material.

In deciding upon what reductions of scantlings or thicknesses are possible in the parts lying towards the ends of a ship, the builder has to note two important facts. First, the gradual narrowing of the ship towards the extremities is in itself a cause of decrease in the strength of cross-sections; it lessens the sectional areas of the planking or plating on decks, sides, and bottoms; and not unfrequently, owing to the reduction in girths, there are fewer longitudinal stiffeners at the ends than amidships. Second, when a ship is very considerably in-lined, the narrowing of the decks produces a virtual decrease in the *depth* of the equivalent girder sections; this may be regarded as the source of a still further loss of strength to the cross-sections lying towards the extremities, which is not in operation when the ship is upright. For the upright position the depth of the equivalent girders then remains practically constant for all cross-sections throughout the length.

These facts, taken in connection with local requirements, have led shipbuilders to make only a small decrease in the thicknesses of the planking, plating, &c. forward and aft as compared with the thicknesses used amidships. In wood ships the thickest outer planking, the wales, is reduced in thickness towards the bow and stern. In iron ships of the mercantile marine it is customary to maintain the midship thicknesses throughout one-half the length, and at the extremities to reduce the thickness of the outer skin by about $\frac{1}{8}$ inch, besides either narrowing the stringers on the decks or decreasing the thickness of stringers and deck plating. Vessels framed on the longitudinal system have, in addition, the depths of their longitudinal frames decreased towards the extremities, and as the girths of the sections become less, the practice is to stop short one or more of the longitudinals. These are the main changes that need now be mentioned; they do not effect any considerable difference in the scantlings at the extremities as compared with those amidships, and although some writers have recommended much more marked differences between the central part of a

ship and her ends, the general feeling and experience of shipbuilders have not gone in this direction.

Local requirements, as remarked above, exercise a very great influence on the longitudinal distribution of the material, often in a direction exactly opposite to that in which the consideration of the strength of the ship as a hollow girder would lead. Many examples of this will occur to the reader who has an acquaintance with the details of shipbuilding; only two or three of the most important can now be mentioned. The plating near the stern in a screw steamer, from the girder aspect of the case, might be made as thin as any plating on the ship, but as a matter of fact it is as thick as any, the reason being that the local strains due to screw propulsion require strong plating to be fitted between the stern-post and the stuffing-box bulkhead next before it. Passing to the other extremity of an ironclad ship, another instance is found. In order to meet the local strains produced by the chafing of the cables, and rubs or blows of the anchors on the bows, it is usual in ships of the Royal Navy to double the plating for some distance; and this additional thickness, of course, adds much to the strength of a ram-bow; but here again, reasoning from the girder, a minimum thickness of plating should suffice.

From the considerations stated in this and the preceding chapter, it will be obvious that the ratio of the depth of a ship to her length should exercise great influence upon the provision of longitudinal strength. The maximum longitudinal bending moment for any class is expressible in terms of the product of the weight into the *length* of a ship. On the other hand, the moment of resistance of an equivalent girder section, like that in Fig. 99, is very considerably influenced by the *depth*. Hence it is usual in merchant ships to make special provisions in ships exceeding eleven times their depth in length; and the shallower a ship is in proportion to her length, the greater should be the amount of material contributing to the longitudinal strength. In

cases where the hull proper is extremely shallow, recourse is had to some device for virtually increasing the depth, like that in Figs. 105 and 106. War-ships of nearly all classes are of greater proportionate depths than merchant ships.

The proportions of length to breadth also have to be considered in adjusting the amount of longitudinal strength; the breadth influences, as we have seen, the strengths of the decks, the plating, &c., and affects the depths and strengths of equivalent girder sections for inclined positions.

In concluding this division of the subject, we will glance at the ratios which the maximum tensile and compressive strains experienced by the upper and lower parts of the structure bear to the ultimate or breaking strengths of those parts. These ratios are technically termed "factors of safety," and they furnish a measure of the reserves of longitudinal strength possessed by ships. For the purpose of calculation it is assumed that the ship is in one of the extreme positions illustrated by Figs. 87 and 88, page 273, and that she is upright at that instant. The equivalent girder for the midship section is then constructed, and its moment of resistance to bending estimated in the manner previously explained. The comparison of this moment of resistance with the bending moment corresponding to the assumed extreme position of support, gives the means of estimating the tensile or compressive strain experienced by any part of the girder section situated at a known distance from the neutral axis.* Calculations of this kind have

* If M be the bending moment of the external forces (say in foot-tons), I the moment of inertia of the equivalent girder about the neutral axis, the sectional areas being taken, say, in *square inches*, and the vertical measurements in *feet*: then, if h_1 be the distance from the neutral axis to the top of the

girder, h_2 being the corresponding distance to the bottom, we shall have the maximum tensile or compressive strains at the top and bottom—say, p_1 and p_2 in tons per square inch of sectional area—given by the equations,

$$\frac{p_1}{h_1} = \frac{p_2}{h_2} = \frac{M}{I}.$$

been made for various classes of ships, and from these a few results may be taken for purposes of illustration.

Professor Rankine, making use of his assumption that the probable maximum bending moment experienced by a ship equalled the product of her displacement by one-twentieth of the length, compared two ships of the same form and displacement, one of wood and the other of iron.* The maximum tensile strain brought upon the upper flange of the equivalent girder of the iron ship he found to be a little less than 4 tons per square inch, or about *one-fifth* the ultimate strength of good iron plates; the corresponding strain on the upper deck of the wood ship was about $\frac{4}{10}$ ton per square inch of sectional area, or about *one-thirteenth to one-fourteenth* part of the ultimate strength of the material. An iron structure can sustain, without injury or change of form, strains which are proportionately much greater than those which can be borne by a wooden structure without permanent change of form. Hence these two ships would be regarded as about equally efficient against longitudinal bending. With iron in bridges, &c. it is assumed, for example, that the "working load," that is, the load which can be repeatedly brought upon the structure without damage, is for iron about *one-fifth* or one-sixth that which would produce fracture, and for strong timber structures only *one-tenth*. It is hardly necessary to repeat that Professor Rankine appears to have fixed too high a limit for his maximum bending moment; so that the actual maxima of tensile strains in the two ships would be less than those stated above; but from other investigations it seems that the two vessels are scarcely average representations of ordinary merchant ships, and further criticism is unnecessary.

The calculations made for Lloyd's Register by Mr. W. John seem to show that when iron merchant ships float on the crest of a wave of their own length and of average

* See pages 158, 159 of *Shipbuilding, Theoretical and Practical*.

steepness, they are frequently subjected to maximum tensile strains on the upper parts much exceeding those experienced by the iron ship just referred to. Moreover, it appears from these very valuable calculations, that there is a great increase in the tensile strain per unit of area as the tonnages of ships increase. For instance, the following results were said to be fairly representative in 1874, and although some improvements have since been introduced, in the shape of stronger upper decks, &c., the figures must still apply to the large majority of merchant ships.

Register Tonnage of Vessel.	Maximum Tension on the Upper Works.
	Tons per Square Inch.
100	1·67
500	3·95
1000	5·19
1500	5·34
2000	5·9
2500	7·1
3000	8·1

This table showed the desirability of adding to the strength of the top flanges of the equivalent girders in the larger classes of ordinary iron ships. It proved, moreover, that the long and large iron steamers now so extensively employed are not provided with anything like the same reserve of strength as is usual in vessels of smaller dimensions, and as is undoubtedly desirable in structures exposed to such extreme and rapid variations of strains. Mr. John estimated that in some cases the maximum tension on ships 400 feet long rises to about 9 tons per square inch, or about one-half of the ultimate strength of the material; and this, as he remarked, is certainly a matter for serious consideration. The adoption of iron or steel decks, and of the longitudinal instead of the transverse system of framing, would, however, remove all these objectionable features, and readily furnish ample longitudinal strength to the largest and longest

ships. This is not a matter of opinion; the *Great Eastern* is a standing witness to the fact.

Turning to vessels of war, it will at once occur to the reader that in the *Minotaur* type the bending moments are proportionately more severe than in any merchant ships, and fears have been expressed lest the structural strength should not prove sufficient to resist these very large moments. It is therefore matter for congratulation that calculations made at the Admiralty prove these heavily armoured vessels of 400 feet in length to be subjected to tensile strains on the upper decks far less than those experienced by merchant ships of equal length. Regarding the armour simply as a burden which contributes no resistance to tensile strains—an assumption which has been shown to be less favourable to the ship than might with justice be made—the maximum tensile strain brought upon the upper deck of the *Minotaur* by a bending moment of 140,000 foot-tons is only about 5 tons per square inch of sectional area; or about *one-fourth* of the ultimate strength of good iron plates, such as are used in her Majesty's ships. This is a remarkable evidence of the superiority of the structural arrangements in the ironclad over those in the merchant ships, so far as regards the resistance to longitudinal bending; the greater depth, as well as the use of strong iron decks, longitudinal framing, and a partial inner skin, in the ironclad chiefly causing the relative gain in strength.

The reduction in bending moments due to the concentration of weights amidships in ships with central batteries, or breastworks like the *Devastation*, is not accompanied by a proportionate reduction in the strengths of cross-sections as compared with the *Minotaur* class; and in some cases there is no loss of strength, the depths being about equal in the two classes. Hence a ship like the *Devastation* has a far greater reserve of strength than the *Minotaur* class possesses. On a wave crest, for instance, the maximum hogging moment is about *one-fourth* for the *Devastation* what it is for the *Minotaur*; and the resulting tensile strain on the upper deck is

only about *one-fourth* that in the *Minotaur*—viz. $1\frac{1}{2}$ ton per square inch of sectional area—when the same assumption is made as to the non-efficiency of the armour against tensile strains. The neutral axis of the equivalent girder for hogging in the *Devastation* is found, under these conditions, to be a little below the middle of the depth; so that the maximum compressive strain on the bottom is very nearly equal to the maximum tension on the upper deck, about 1 ton per square inch of sectional area. This again is a remarkable contrast to an ordinary iron merchant ship, where the comparative weakness of the top flange brings the neutral axis of the girder for hogging down to about two-thirds of the total depth from the top; and consequently makes the compressive strain on the bottom, not much more than half the tensile strain on the top of the girder.

When sagging moments act upon an ironclad, her armour can assist the structure in resisting compressive strains, and this fact tells greatly in favour of the *Devastation* and similar vessels, for which the severest bending moments are those experienced when astride a wave hollow. For instance, in the *Devastation* herself the maximum sagging moment for this position is 40 per cent. greater than the maximum hogging moment corresponding to support on a single crest; yet the armour helps so much against sagging that the maximum tensile strain on the bottom only rises to $1\frac{1}{2}$ ton per square inch of sectional area. The neutral axis of the equivalent girder for sagging is, in this case, situated much higher than that of the girder for hogging, being about one-third of the total depth of the ship below the upper deck; hence the upper deck, under the maximum sagging moment, has to resist the very moderate compressive strain of about $\frac{2}{3}$ ton per square inch. Against sagging strains the *Minotaur* type has the help of the armour, and (what is still more important) has to resist a maximum bending moment only equal to about one-half of that for hogging; so that astride the wave hollow there is a very much larger reserve of strength than there is for support upon a single wave crest.

Enough has been said to show that ironclad ships of the Royal Navy, notwithstanding the great weights of armour carried on their sides, and the necessity for complying with the requirements for offensive and defensive purposes, are much stronger longitudinally, in proportion to the strains brought upon them, than are merchant ships of the largest size. Recent types are also seen to gain greatly, as compared with earlier types, in their reserve of longitudinal strength. Both these results must be admitted to be highly satisfactory when the novelty and difficulty of ironclad ship construction are borne in mind. With these remarks we must take leave of this important subject.

The principles which govern the provision of *transverse strength* admit of being explained much more briefly than do those for longitudinal strength. In nearly all classes, the transverse frames or ribs, the deck-beams, and the planking or plating of the skin and the decks, together with the pillars under the beams, and the beam-knees, &c., connecting the decks with the sides, contribute to the transverse strength. Iron ships have the further advantage of the strength supplied by more or less numerous transverse bulkheads; and so have most composite ships, as well as many wood ships of recent types. It will be convenient, therefore, to arrange the discussion of this branch of the subject under the following heads:—(1) The strength of the transverse frames or ribs; (2) the strength of deck-beams, and their connections with the sides; (3) the strength obtained by pillars; (4) the usefulness of bulkheads in relation to transverse strength.

With each transverse frame, or rib, a portion of the skin, both inside and outside, may be considered to act in resisting changes of transverse form. For example, suppose in Fig. 103 (page 324) the ribs to be spaced 2 feet apart. If two imaginary planes of division are drawn cutting the skin

midway between the frame chosen and the frames adjacent to it on either side, this strip of skin may be regarded as forming an outer flange of a girder, the web and inner flange of which are formed by the frame. The enlarged section, placed a little below the upper deck in Fig. 103, shows the sectional form of this girder. Similarly each deck-beam may be regarded as associated with a strip of the deck-planking or plating; and, taking the beams with the frames to which they are attached, each of the combinations may be regarded as a *hoop-shaped girder* having in itself considerable strength to resist change of transverse form. Similarly in wood ships each rib and beam may be regarded as associated with the adjacent strips of inner and outer skins. It is unnecessary to say anything further respecting the skins, as considerable attention has already been given to their arrangements in different classes; but it is desirable to note briefly some of the chief differences in the construction of the transverse frames.

The ribs of wood ships are necessarily made up of several lengths (or futtocks) which are either bolted and dowelled (as shown in Fig. 102) or else connected to each other in some other way, which leaves adjacent pieces comparatively free to bend inwards or outwards in relation to one another. As a consequence no single rib can be regarded as having much strength in itself against strains tending to change its form: the butts of the various futtocks are places of comparative weakness which can scarcely be avoided. The shipbuilder, therefore, has recourse to the plan shown in the inside view, Fig. 102; if any butt is taken in the diagram, it will be seen that between that butt and the next butt, similarly placed, three unbutted timbers intervene; this is termed a "*shift* of butts," and the effect is to succour the ribs at the butts by the unbroken strength of adjacent ribs. This object is effected satisfactorily; but the framing must be weaker than it would be if the individual ribs could offer considerable resistance to changes of transverse form. Formerly it was the practice to fit transverse timber riders

within the ribs in order to strengthen the latter, but the practice died out when diagonal riders came into use.

The ribs of ordinary iron and composite ships are much stronger individually than those of wood ships. Fig. 103 explains their construction (see especially the enlarged sections), and it will be noted that each frame is really a Z-shaped girder, the flanged section giving it great strength to resist alterations of form. The angle-irons and plates of which the frame is made up are either obtained in one length or else welded or butt-strapped into the necessary lengths: the whole being so combined that there are no places of weakness corresponding to the butts in the ribs of a wood ship. This superiority shows itself markedly during the process of building a ship, the frame of a wood ship usually being built up piece by piece, whereas the frames and beams of iron ships are very frequently put together before being hoisted into place, and sustain no sensible change of form during that operation. Below the bilges floor-plates are fitted, gradually increasing in depth towards the keel: these floors are of great value in resisting transverse bending strains, as well as forming supports for cargo, &c.

Vessels in which the main frames lie longitudinally usually have their transverse frames spaced much more widely than in iron ships of the ordinary construction. In vessels of the mercantile marine built on the system advocated by Mr. Scott Russell, the only transverse frames—excluding the complete bulkheads—are placed from 12 to 20 feet apart, and formed by plates fitted in between the longitudinals, with stiffening angle-irons on the edges of the plates. These plate-frames are termed “partial bulkheads,” resembling the outer rim of a transverse bulkhead of which all the central parts have been cut away. Their principal use is to furnish a series of sections having considerable transverse strength and situated between the complete bulkheads; also to stiffen the longitudinals, and keep them in their proper positions. The *Great Eastern* has no other transverse frames than such

partial bulkheads ; but the existence of an inner skin adds greatly to the transverse strength, this skin forming strong inner flanges to the hoop-shaped girders, of which the outer bottom forms the outer flanges, and the plate-frames the webs. It should be added that in vessels so constructed the longitudinal frames are commonly made very numerous, in order to stiffen the bottom ; but even when these frames are spaced only 3 or 4 feet apart, the spaces of bottom plating left without direct support have areas of from 40 to 60 square feet, and hence results an amount of flexibility in the bottom which may become objectionable.

To obviate this objection, and give greater support to the bottom, as well as to increase the transverse strength, the ironclad ships of the Royal Navy, built on the bracket-frame system illustrated by Fig. 104, have the transverse frames 4 feet apart. Most of these frames, within the limits of the double bottom, are formed as in the diagram, plate-brackets being fitted to connect the inner and outer angle-irons with each other and with the two skins ; as well as to secure the longitudinals to the skins, and prevent any change of angle. This light and simple arrangement gives considerable transverse strength, but it is reinforced at intervals of about 20 feet by partial bulkheads similar to those used by Mr. Russell, and forming watertight partitions in the double-bottom space. Underneath the engine-room, where considerable strength is required to meet the strains due to the motions of the machinery, instead of bracket-frames, it is usual to fit plate-frames filling the spaces between the longitudinals, and to cut lightening-holes in them. Before and abaft the double bottom also, where there is no inner skin to contribute to the transverse strength, similar lightened plate-frames are fitted.

The bracket-frame system of construction was introduced by Mr. Reed when Chief Constructor of the Navy, and has been generally adopted in the construction of foreign ironclads. It differs from the system used in the *Warrior* and other early ironclads mainly in the adoption of the complete

double bottom and the more complete subordination of the transverse to the longitudinal framing. In the *Warrior*, for example, the transverse frames were more numerous and heavier than in recent ships. Their greatest spacing was about 44 inches; and for a considerable part of the girth intermediate frames were fitted, reducing the spacing to 22 inches. All these were lightened plate-frames, with strong, heavy, continuous transverse frames on the inner edges. Moreover, about 30 or 40 feet of the length at each end of the *Warrior* was framed transversely, the longitudinals being stopped short; and at these parts the transverse frames were as closely spaced as those of ordinary merchant ships. In the *Minotaur* class quite as great prominence was given to the transverse frames, which were spaced 28 inches apart. The changes effected in ships built on the bracket system have enabled considerable savings to be made in the weight and cost of hull, at the same time that the safety and general structural strength have been increased. Examples of these savings appear at page 370.

Allusion has already been made to the close spacing of the transverse frames behind armour in all ironclads; and it is unnecessary to add to these remarks. If there were no armoured side to be supported, a wider spacing of these frames would be adopted; and, in fact, this is the arrangement made in the unarmoured upper works of ships with central batteries or citadels.

The swift cruiser class of the Royal Navy have iron hulls sheathed with wood planking, and consequently have no double bottoms. The transverse frames are spaced $3\frac{1}{2}$ feet apart from keel to gunwale, which is about twice the frame-space of large iron merchant ships; and this is found to answer admirably, notwithstanding the great engine-power, fine forms, and heavy armaments carried on the decks. If mercantile shipbuilders should at length abandon the transverse system of framing, they will find instructive examples for future guidance in the *Inconstant* and her consorts. These vessels have simple wide-spaced transverse

frames, combined with good bulkhead arrangements and strong longitudinals: apart from their sheathing, their construction presents but little more difficulty than that of ordinary iron merchant ships, and it is much more favourable to the association of strength with lightness.

Brief reference must next be made to the assistance which the *deck-beams and pillars* render in preserving the transverse forms of ships. The first duty of the beams is to support the decks with their loads; this was the purpose for which beams were originally fitted. But the beams have other uses. As the various transverse strains previously described are brought to bear upon the structure, the tendency at one time may be to increase the distance between opposite sides of the ship, and at another instant to decrease it. In other words, the beams have to act as ties and struts alternately between the opposite sides. Similarly, the pillars were first fitted as struts or supports to the beams, to assist in supporting the decks; but as the vessel rolls in a seaway, the strains tending to produce alteration of transverse form sometimes produce an increased thrust upon the pillars, and at others produce a pull or tension, if the pillars are well secured at both the heads and heels. Should the pillars be only capable of acting as struts, and not as ties, one important part of their possible usefulness is lacking, because they are powerless to resist any increase in the heights of the decks above the keel.

The beams of wood ships are ordinarily of wood, of rectangular cross-section, and formed of different pieces, joined together by more or less elaborate scarphs, some of which are illustrated in Figs. 109–112, pages 381, 382. The beam-ends very frequently rest upon a shelf-piece (see Fig. 102) which is bolted to the inside of the frame timbers, and are so secured to it (by dowels, &c.) as to be capable of withstanding a considerable force tending to pull the beam away from the side. Above the beam-end another strong longitudinal timber, the “water-way,” is securely bolted to the

timbers and strongly connected with the beam, greatly increasing the strength of its connection with the side. In all these ways the beam is made capable of acting as a *tie* between the opposite sides. Its action as a *strut* is secured by very accurately fitting its ends against the inside of the timbers, and by the pillars which tie the centre down to the keelson and lower parts of the hull. Thus far the arrangement is satisfactory, but it involves considerable skill and cost in scarphing the pieces that form the beam, and connecting the beam with the water-way, shelf-piece, &c. It will be noted, however, that the rectangular form of cross-section is necessarily inferior to the flanged form; and this is an unavoidable defect with wood beams. These considerations have led to the extensive use of iron beams in recent wood ships; similar care being taken to make good the connection of the ends of these beams with the side, in order that they may act as struts or ties. Wood pillars also have fallen greatly into disuse even in wood ships, iron pillars of less weight being readily made more efficient as ties, and no less efficient as struts under the beams.

Iron ships have iron beams, which can be readily obtained of various sectional forms, all of which have more or less of that flanged form which has been shown to be so helpful to the association of strength with lightness (see Fig. 116, page 385). Like the frames, these beams can be easily welded, or strapped, into what is practically one piece, capable of resisting both tension and compression. Moreover, their ends are very simply and strongly secured to the frames (see Figs. 103 and 104), the stringer plates on the beam-ends greatly strengthening the connection of the beams with the side. Iron tubular or flanged pillars can be associated with the iron beams, and made to resist either tension or compression. In every way, as regards strength and simplicity, the iron ship has the advantage of the wood one in the character and connections of the beams and pillars. The composite ship in these particulars resembles the iron ship.

The lower decks of ships are often extended over only a

portion of the length, or else considerably weakened by having large openings out in them. Merchant ships, for example, frequently have no lower decks in wake of the cargo holds, and consequently there is not nearly the same strength of connection between opposite sides at those parts as would be secured by a strong deck with its beams. To compensate in part for this loss of strength, it is usual to fit a few strong beams—known as hold-beams—in the cargo spaces; the convenience of stowage is thus little affected, while the strong beams form good ties and struts. In very many cases where such precautions have not been taken, serious working and change in transverse form have resulted.

Perhaps the greatest point of difference between the action of the beams in wood and iron ships is to be found in their comparative resistances to *change of the angles* between the decks and the sides of the ship. The strains tending to produce such changes have been previously described; and their effects on wood ships have been so serious as to cause shipbuilders to bestow great attention upon beam-knees and their connections. A vast number of plans for beam-knees have been proposed. Formerly, before iron strengthenings became general, cumbrous timber knees were fitted; and in countries where timber is abundant such knees are even yet employed. Forged iron knees are, however, now much more generally employed, and are more efficient than timber knees, as well as less bulky. But even with the best of these arrangements—such as the knees shown under each beam-end in Fig 102—heavy rolling in a seaway may produce sensible changes of angle. The usual indications of these changes are loosening of the fastenings which secure the iron knee to the side and to the beam-end; and in the larger classes of wood frigates and line-of-battle ships in the Royal Navy these indications were not at all uncommon, notwithstanding the precautions taken in fitting and bolting the knees.

The reasons for the superior resistance of iron ships to any

corresponding change will be obvious on comparing Fig. 102 with Figs. 103 and 104. The beam-ends of the iron ships are shaped into strong knees, far more capable, from their form, of preventing change of angle. These stronger knees are fitted against the sides of the frames, and strongly riveted to them: the frames themselves are riveted to the skin, and in very many cases the stringer plates on the beam-ends are also directly connected with the skin, so that the beam-end cannot change its position relatively to the side of the ship without shearing off numerous rivets, or fracturing plates and angle-irons. Hence it is obvious that, with properly proportioned knees and riveting, change in the angle made by the decks of iron ships with the sides may be almost entirely prevented. Imperfect fastenings in the beam-knees may permit, and in some cases have permitted, working at the junction of the decks and sides even in iron ships; especially when they have happened to be associated with a considerable amount of flexibility in the frames to which the beams are attached. But these cases can only be regarded as examples of a defective application of principles which, when properly applied, lead to satisfactory results.

Similar knees are formed on iron beams fitted to wood ships, but then instead of attaching the beam-arm directly to an iron frame, as can be done either in an iron or composite ship, it has to be secured to the side by means of angle-irons riveted through the beam, and bolted to the side planking and timbers. This plan is more efficient in preventing change of angle than the ordinary knees fitted to wood beams, but not so efficient as that of iron and composite ships, the connection with the side not being so perfect.

Sometimes deep plate-knees are fitted below a few of the beams in iron ships, reaching from one deck to that next below it, for the purpose of stiffening the side. The beams forming the boundaries of large cargo-hatches or boiler-hatches in merchant ships are often treated in this manner, and made deeper and stronger than the other beams, for the purpose of compensating for the loss of transverse strength produced

by cutting off the beams to form the openings in the deck. In the iron-built ships of the Navy also, it is common to fit what are termed "partial bulkheads" at intervals between the main and upper decks, in order to stiffen the sides and to assist the beam-knees in preventing change of angle. Each of these partial bulkheads is very simply formed by a plate 3 or 4 feet wide, connected at its upper end to the beams or stringer plate of the upper deck, at its lower end to the stringer plate on the main deck, and also attached to the side plating. They are commonly fitted above the deck at which the main transverse bulkheads terminate; below this deck the main bulkheads give great assistance to the structure, and lessen the strains brought upon the beam-arms.

Not unfrequently it is a convenience to be able to dispense with knees to lower deck beams; a case in point is illustrated by Fig. 26, page 35. If the ship has a sufficient number of transverse bulkheads, this disuse of beam-knees is no source of weakness. Moreover, it will be remembered that the transverse racking strains described in a previous chapter are likely to be more severe on the upper and main decks than on the lower decks. These racking strains chiefly cause the alterations of angle between the decks and sides, as well as deformations at or near the bilges; but it is especially at the upper parts of the structures of iron ships that their effects require to be provided against by strong beam-knees and partial bulkheads.

Transverse iron bulkheads, when properly constructed, add greatly to the transverse strength of all ships, but are most valuable in iron ships having the main frames placed longitudinally and the transverse frames widely spaced. The cross-sections at which such bulkheads are placed may be regarded as practically unchanged in form, under the action of the severest transverse strains experienced by a ship, provided the thin iron plating which forms the partition be stiffened by angle-bars, T bars, or Z bars riveted to its surface. The most perfect arrangement of the stiffeners is that which

places one set vertical and the other horizontal, the plating being thus prevented from buckling in any direction. The decks which meet the bulkheads lend very material help by stiffening them and thereby preventing change of form. Having thus secured great local transverse strength, it becomes necessary to provide the means of distributing it over the spaces lying between any two bulkheads; this end is best accomplished by means of strong longitudinal frames, which are carried from bulkhead to bulkhead, and rest upon them just as the girders of a bridge rest upon the piers. It thus appears that the efficiency of the transverse bulkheads as stiffeners to the structure depends upon their numbers, the distance between consecutive bulkheads, and the capability of the longitudinal framing to distribute the strength of the bulkheads. Ordinary iron ships, having comparatively few bulkheads, do not gain so much from their help as ships with bulkheads spaced more closely. The desire to have large cargo-spaces in the hold, free from break or interruption, overrides, in most cases, considerations both of increased safety and greater strength. A compromise is sometimes made by fitting, at intervals between complete transverse bulkheads, "partial" bulkheads, formed by deep plate-frames with angle-irons on both inner and outer edges, very similar to those fitted in vessels built on the longitudinal system. But there are considerable spaces in the length of ordinary iron merchant ships for which the transverse frames have to furnish the principal part of the transverse strength, and the fewness of the bulkheads is one reason for retaining the close spacing of these frames.

When a large number of transverse bulkheads is fitted in an ordinary iron ship, the distribution of their strength over the bottom mainly depends upon the longitudinal stiffeners—keelsons, hold stringers, &c. These include very various arrangements, of very various degrees of efficiency; but in none is the distribution so simply and efficiently made as in vessels where the main frames are longitudinal (as in Fig. 104). Longitudinal bulkheads, when they are

fitted either at the middle line or towards the sides (or wings), largely assist in the distribution of the strength of transverse bulkheads. In short, all the pieces lying longitudinally, which are efficient against longitudinal bending strains as well as against some local strains, are also valuable distributors of transverse strength.

Composite ships are often fitted with transverse iron bulkheads, the vessels of that class belonging to the Royal Navy being exceptionally well subdivided. These bulkheads contribute much transverse strength, which is distributed very similarly to that for ordinary iron ships, except that the longitudinal pieces are not so well connected to the skin. Closely spaced transverse frames are trusted, however, to supply the chief part of the transverse strength.

Wood ships of recent types in the Royal Navy, and in some foreign navies, have been furnished with transverse iron bulkheads, and the results have been very satisfactory; but there must be greater difficulty in making the bulkheads succour parts lying between them in wood ships than there is in iron ships; and the attachment of the bulkheads to the sides is not so efficient as it is in either iron or composite ships.

The foregoing sketch of the arrangements made to secure longitudinal and transverse strength in different classes of ships has necessarily been hasty and imperfect. It may, however, serve as a guide to the reader whose interest in the subject leads him to study it more in detail in works devoted to practical shipbuilding. Keeping in mind the principles of structural strength that have been illustrated, and the character of the strains to be resisted, it will be possible to examine intelligently the system of construction adopted in any ship; otherwise such an examination would be impossible.

CHAPTER X.

MATERIALS FOR SHIPBUILDING: WOOD, IRON, AND STEEL.

WOOD, iron, and steel are the three classes of materials from which the shipbuilder of the present day can select. Wood ships have been in use from time immemorial; iron ships for sea-going purposes have not yet completed the first half-century of their construction; steel ships are of a still more recent date. Already wood ships are superseded to a very large extent by iron, and many persons believe that before another half-century has passed iron will have given place to steel. Hitherto the use of steel has not become general, for reasons which will be stated hereafter; but quite recently both in France and in this country considerable progress has been made in the manufacture of mild steel well adapted for shipbuilding, and the two first vessels built wholly of such steel are now in process of construction for the Royal Navy.

In contrasting the merits of these materials, it will be convenient first to compare wood with iron; afterwards briefly comparing iron with steel. This course will have the further advantage of fairly representing present practice, iron ships being many, while steel ships are few.

Our main purpose in this chapter is to examine into the qualities which make iron superior to wood, when the numerous pieces which make up the structure of a ship are combined and connected together, and subjected to the action of the different kinds of strain previously described. Before proceeding to this discussion, it may, however, be

interesting to give a few facts illustrating the wonderful development of iron shipbuilding during the last twenty-five years.*

In 1850, out of 133,700 tons of shipping added to the British mercantile marine, only 12,800 tons, less than *one-tenth*, were iron ships; in 1860, out of 212,000 tons added, 64,700 tons, nearly *one-third*, were iron ships; in 1868, out of 369,000 tons added, no less than 208,000 tons were iron ships. In 1875, out of 420,000 tons of newly built ships, 374,000 tons, nearly *nine-tenths*, were iron ships.

If attention be limited to steamships, the results are still more striking, wood having kept its place much better in sailing ships, although even there it is yielding rapidly to iron. In 1850, out of 275,000 tons of British mercantile steamers on the Register, *four-fifths* (218,000 tons) were of wood. In 1860 the total had increased to 686,000 tons; and nearly *five-sixths* (536,000 tons) were of iron. In 1868 the grand total on the Register had nearly doubled again, being 1,341,000 tons; out of this total, wood ships only represented 122,000 tons, steel ships about 8800 tons, and the remainder (1,210,000 tons) were iron-built. During 1875 a tonnage of 179,000 was added to British steam-shipping, and 176,000 tons were iron-built.

The Royal Navy presents a similar picture. In 1850 the tonnage (B.O.M.) of wood ships had a total of 99,000 tons, against 19,500 tons for iron ships. In 1860 the proportion of wood to iron was even greater than at the earlier date, 420,000 tons, against 34,800 tons. But with the construction of armoured ships iron hulls became general; and in 1870 the total tonnage of wood ships had fallen to 386,000 tons, while that of iron ships had nearly quadrupled since 1860, becoming 130,200 tons. At the present time quite three-

* See a paper on "Iron Shipbuilding," by Mr. C. M. Palmer, in the *Transactions* of the Iron and Steel Institute for 1870, and the Board of Trade Returns.

fourths of our ironclads, including all the ships added to the Navy during the last ten years, have iron hulls; and it is a significant fact that not a single wood ship is now being constructed for the Navy.

Iron shipbuilding originated in this country; has here received its most important developments; and has been the source of very great advantage. It has rendered us practically independent of foreign supplies of shipbuilding materials; which were becoming more and more important in the later days of the supremacy of wood shipbuilding, when the supplies of home-grown timber were quite inadequate to home requirements. Such supplies from abroad were liable to interruption in time of war; and during peace they placed English builders at a great disadvantage, as compared with builders in countries where shipbuilding timbers were abundant and cheap. The United States, Canada, France, and Italy, all furnished ample supplies of suitable timber; and the shipbuilding trade—so peculiarly British—seemed about to pass away into other hands, when the use of iron instead of wood once more restored the balance, and enabled us to regain our former national position.

But more than this: the use of iron ships has been the source of world-wide advantage. Had wood remained in use, ocean steam navigation could never have attained its present wonderful development, and international communication must have remained less regular and frequent. Without iron hulls, the ironclad reconstruction could never have been carried to its present position; nor could the swift cruisers have been built. Moreover, iron shipbuilding has done very much to encourage progress in the manufacture of wrought iron for all structural purposes, and thus has indirectly benefited other departments of work. In short, the experience of forty years fully confirms the wisdom of the change from wood to iron, and proves that, although iron has some drawbacks, it possesses a considerable balance of advantage. Other nations, endowed with a wealth of ship-

building timber, have not failed to realise this: in France, Italy, and still more noteworthy in the United States, iron is rapidly gaining ground, and English models are being imitated or improved upon.

A better appreciation of the great increase in the sizes and proportions of ships which has accompanied the use of iron hulls in both the Royal Navy and the mercantile marine will be obtained from a few typical examples. Taking the Royal Navy first, the following tabular statement will suffice:—

Class of Ship.	Date of Construction.	Name.	Displacement.	Indicated Horse-power.	Length.	Breadth.
<i>Wood, unarmoured.</i>			Tons.		Feet.	Feet.
Largest sailing three-deckers	1815	<i>St. Vincent</i> .	4,700	—	295	53½
" screw	1859	<i>Victoria</i> . .	6,950	4,190	290	60
" " two-deckers .	1860	<i>Duncan</i> . . .	5,700	2,820	282	58
" " frigates . .	1857	<i>Orlando</i> . . .	5,600	4,000	300	52
<i>Wood, armoured.</i>						
Largest class	1863	<i>Lord Warden</i>	7,840	6,700	290	59
<i>Iron, unarmoured.</i>						
Swift cruising frigate . . .	1866	<i>Inconstant</i> .	5,780	7,360	337	50½
<i>Iron, armoured.</i>						
Early broadside ships . . .	1859	<i>Warrior</i> . .	9,100	5,470	390	56
	1861	<i>Minotaur</i> . .	10,600	6,700	400	56½
	1865	<i>Hercules</i> . .	8,700	8,530	325	59
Modern " "	1873	<i>Alexandra</i> .	9,500	8,600	325	63½
	1869	<i>Devastation</i> .	9,290	6,650	285	62½
Mastless type (sea-going). .	1871	<i>Dreadnought</i>	10,890	8,000	320	63½
	1874	<i>Inflexible</i> .	11,400	8,000	320	76

This increase in size has not merely been associated with the special strains due to the use of armour, but with the adoption of proportionately more powerful engines, and the attainment of higher speeds. The best of the screw line-of-battle ships of the old type attained from 12 to 13 knots at full speed; this latter speed was also the maximum of the finest wood frigates. But now the armoured battle-ship has a speed of 14 to 15 knots; and the swift cruiser class have speeds of from 15 to 16 knots. Wood hulls could scarcely be expected to meet satisfactorily these greatly changed conditions; but iron hulls have answered the purpose, and there is no reason to think that the limits of the capabilities

of the material have been reached, even in the largest and swiftest ships afloat. Great engine-power in wood-built ships is very trying and injurious to the structures; but no similar wear and tear occurs with iron. The *Orlando* and her sister frigate, the *Mersey*, were, when constructed, experiments in the direction of applying large engine-power and great proportions of length to breadth in wood ships; but the results were anything but satisfactory. These vessels required considerable repairs during their brief period of service, and rapidly fell out of use. Against this failure to sustain successfully the strains incidental to screw propulsion, set the case of the iron-built *Inconstant*, which is longer than the *Orlando*, of less beam, three knots faster, with 80 per cent. greater engine-power, and yet, thanks to her iron hull, displays no signs of working or weakness.

In the United States the attempt was made to build swift cruisers, the famous *Wampanoag* class, of wood. Without entering into any details of the controversy respecting this class, it may be stated that, on all hands, it is now admitted that the wood hulls were not well suited for the great engine-power put into the ships. The fact that several of the class have been left unfinished or unemployed after trial shows the estimation in which the vessels are held by the authorities of the American Navy. Further, it is interesting to note that American shipbuilders are, at length, devoting themselves energetically to the development of iron ship construction. Several small iron vessels have been recently added to their navy; and iron has been used for the hulls of many large fast steamships for ocean navigation. French designers have also acknowledged the superiority of iron to wood, by building their swift cruisers on the model of the *Inconstant*, and their ironclads on the bracket-frame system illustrated in Fig. 104, page 331.

In the mercantile marine, scarcely less remarkable changes have been made in the sizes and proportions of ocean steamers. Take, for example, vessels on the Transatlantic service. Not quite forty years ago, the wood-built *Great*

Western was considered a remarkably fine vessel; her dimensions were, length 210 feet, breadth 35½ feet, tonnage (B.O.M) 1340 tons, load displacement 2300 tons. She was followed, in 1840, by the *Great Britain*, built of iron, of which the dimensions were, length 290 feet, breadth 51 feet, tonnage 3270 tons (register), original load displacement 3000 tons. These dimensions were then considered extravagant, if not unsafe; but the ship was quite recently at work, on the Australian line, although thirty-five years old. The changes made since her construction are still more remarkable. The largest Transatlantic steamers now at work are 490 feet long by 44 feet beam, and about 5500 tons (register), their displacement, when fully laden, being from 9000 to 10,000 tons. No one can for a moment suppose that such sizes and proportions could have been achieved with wood as the material, in conjunction with very powerful engines and extremely high speeds. Finally, as a crowning example of what may be done with iron, take the *Great Eastern*, 680 feet long, 83 feet broad, of 22,500 tons (register), and load displacement 27,400 tons, which after some fifteen years' service still remains strong and efficient, having meanwhile performed most arduous work in laying various submarine telegraph cables.

Iron ships are proved to be superior to wood in the following important particulars:—(1) Lightness combined with strength; (2) durability, when properly treated; (3) ease and cheapness of construction and repair; (4) safety, when properly constructed and subdivided. On the other hand, iron ships are inferior to wood in—(1) easy penetrability of the bottom by rocks or other hard pointed substances; (2) fouling of the bottom, and consequent loss of speed, after being afloat for some time. Compass correction in iron ships is now so satisfactorily performed that there is no need to refer to a matter which at the outset had great practical importance. Taking these points in the order in which they have been named, each of them will be illustrated briefly; and after concluding these remarks, a few will be

added on the subject of the use of iron hulls in unarmoured ships of war.

First, as to lightness combined with strength. In wood-built ships of the Royal Navy it is found that about *one-half* the total weight is required for the hull; in similar ships of the mercantile marine the hulls are somewhat lighter in proportion to the displacement. In iron merchant ships the hull frequently weighs only *one-third* of the total weight, high authorities agreeing that the change from wood to iron effects a saving of from 30 to 40 per cent. on the weight of the hull. The iron ships of the Royal Navy are not, as a rule, so lightly built as iron merchant ships, the difference being due to differences of form and the special requirements of their service. In some of the earlier iron vessels of the Navy, both armoured and unarmoured, the hulls were as heavy as, or even heavier than, the hulls of wood ships, in proportion to the displacements. But as the principles of iron ship construction have become better understood, considerable savings in weight of hull have been effected simultaneously with an increase in structural strength, and now it is not uncommon to find the weight of hull only 30 to 40 per cent. of the total displacement, in vessels carrying the thickest armour and heaviest guns. This expression of the weight of hull as a fraction of the displacement, or total weight, of the ship is by no means a complete view of the comparison of wood and iron ships. It takes no cognisance of the fact, to be hereafter illustrated, that forms, sizes, and proportions are now commonly adopted that could never have been used with wood as the material; and it does not recognise the variations which, for similar methods of construction, have to be made in the ratio of the weight of hull to the displacement, in order to secure equal structural strength in vessels of different sizes. It is, however, a sufficiently accurate mode of comparison for our present purpose, and is very commonly used. The following tabular statement will show at a glance the advantages in point of lightness possessed by iron ships of various classes;

most of the figures are taken from actual ships, and may therefore be accepted without question.

Classes of Ships.	Percentage of Displacement.	
	Weight of Hull.	Weight Carried.
Wood merchant ships	35 to 45	55 to 65
" war-ships, unarmoured	50	50
" " " ironclad	48 to 50	50 to 52
Iron merchant ships.	30 to 35	65 to 70
" troopships, Royal Navy, early types	50 to 52	48 to 52
" " " " later types	48 to 50	50 to 52
" war-ships, unarmoured (swift cruisers)	50	50
" " " ironclad, early types	52 to 58	42 to 48
" " " " later types	40 to 45	55 to 60
" " " " mastless type	30 to 35	65 to 70
" " " " circular type (Russian).	20 to 22	78 to 80

Notes to Table.

The *Orontes* and *Tamar* are the representatives of the earlier troopships. The Indian troopships represent the later types, and possess a double bottom, which their predecessors did not possess, being safer as well as lighter.

In the weight of hull for the swift-cruiser class there is included a considerable weight of wood sheathing, fixed outside the iron hull in order that the bottoms might be coppered or zincked. This wood is unnecessary for structural strength; excluding it, the percentage for hull would sink to about 42 per cent. of the displacement, notwithstanding the great engine-power and high speed of the ships.

The case of the ironclads is so important that the following additional illustrations may be interesting; they are taken from Mr. Reed's work on *Our Ironclad Ships*, and other trustworthy publications.

Ironclads of Royal Navy.		Weight of Hull.	Weight carried.	
Early types	} <i>Black Prince</i> (broadside)	Tons. 4970	Tons. 4280	
		} <i>Defence</i>	3500	2500
Recent types	{ <i>Bellerophon</i>		3650	3800
		{ <i>Monarch</i>	3670	4630
			{ <i>Invincible</i>	2740
		{ <i>Devastation</i> (mastless)		2880

Notes to Table (continued).

The explanation previously given of the structural changes by which these remarkable results have been accomplished need not be repeated.* Perhaps the saving in weight will be better appreciated when it is stated in another form. In a large ironclad of 8000 to 9000 tons displacement the decrease in weight of hull would amount to quite 800 or 1000 tons, and this being transferred to the carrying power constitutes a most notable addition thereto. At the same time a stronger, safer ship is obtained. The moderate freeboard of the mastless type conduces to their greater lightness of hull. See the remarks on page 349 as to the greater strength of the war-ships when compared with merchant ships, and as to the superiority of the recent types of ironclads when compared with earlier types.

Iron ships are, then, undoubtedly superior to wood ships in their combination of lightness with strength; and the chief causes contributing to the difference may be briefly summarised.

Each piece in the structure of a ship may be regarded in a twofold aspect: first, as an individual piece liable to be subjected to tensile, compressive, bending, or torsional strains; secondly, as a piece combined with and fastened to adjacent pieces in order that it may assist the general structural strength. Following the method of the preceding chapters, this may be expressed by saying that the various pieces making up the structure must be arranged with reference to both the local and the general requirements. Moreover, the foregoing discussion will have shown that tensile and compressive strains are of the first importance: bending strains have to be borne by some pieces, such as the deck-beams, the ribs, and longitudinals, but these strains are less important; while torsional or twisting strains are of rare occurrence, and scarcely require consideration.

Let the resistances of *single pieces* of wood and iron to tensile or compressive strains be first considered. Take a simple tie-bar, for example, and suppose a certain weight suspended to one end while the upper end is fixed. As the weight is gradually increased, the bar will begin to stretch: for a certain increment of weight the elongations will be

* See page 355.

directly proportional to the suspended weight, and when the latter is removed, the bar will return to its original length: the limits within which this condition holds are termed the "limits of elasticity," or sometimes the "elastic limits." As the suspended weights are still further increased, and the limits of elasticity are passed, if the weights are removed, the bar will be found not to return to its original length, but to have a permanent elongation or "set." Finally, as the weights are yet further increased, they will become sufficient to break the bar; and this determines the *ultimate strength* of the bar. As a measure of precaution, the strain brought upon this tie-bar, and likely to be frequently repeated, ought not to exceed the limits of elasticity; otherwise the permanent set might, in the end, become dangerously increased. And as a matter of fact, in structures exposed to severe tensile strains, the maximum strain likely to be brought upon any piece frequently is rarely allowed to exceed more than *one-half* or *one-third* the strain which would just bring the piece to its limit of elasticity. Within those limits, as was said, the strains produce elongations proportioned to their magnitude. Let the bar, for example, be L feet long, and let it be observed to stretch $\frac{1}{n}$ -th part of its length, under a strain of P lbs. per square inch of the sectional area of the bar: then for any other strain Q we must have

$$\text{Elongation} = \frac{Q}{P} \times \frac{L}{n}.$$

If it were possible without passing the limits of elasticity to *double* the length of the bar, and E were the strain which would produce this elongation, we must have

$$L = \frac{E}{P} \times \frac{L}{n}; \text{ whence } E = Pn.*$$

* To illustrate the use of this formula, we will take an actual experiment. A piece of English oak was found to stretch $\frac{1}{1153}$ of

its length under a strain of 1680 lbs. per square inch. Hence $E = 1152 \times 1680 = 1,935,000$ (nearly), the required modulus.

This is confessedly a hypothetical case, since no bar could be stretched to double its length, and return to the original length when the strain was removed; but the hypothesis can be advantageously used in practice. The quantity *E* is termed the *modulus of elasticity*, and its comparison for various substances furnishes a ready means of estimating the relative efficiencies of the different materials in resisting change of form. This is equally applicable to compression, within certain limits, as it is to tension.

In a ship or any other structure it is desirable that no permanent set shall take place in any piece; in other words, that no piece shall be strained beyond its elastic limits. In different materials the *elastic* strength, as it may be termed, bears various ratios to the *ultimate* strength. In wrought iron or steel, for example, the limits of elasticity are not passed until a strain is reached equal to about one-half the breaking strain; the elastic strength being about one-half the ultimate strength. In timber, on the contrary, the elastic strength appears not to exceed one-third or one-fourth the ultimate strength; but the limits of elasticity have not been accurately determined. For absolute resistance to fracture, the shipbuilder has to consider the ultimate strengths of the materials employed; for ordinary conditions of service he has to consider what shall be the *working* strains which can be repeatedly brought upon the various parts without producing permanent change of form. The ratios which these working strains bear to the ultimate strengths are termed "factors of safety." These explanatory remarks will enable us to compare with more precision the relative efficiencies of wood and iron.

Take, first, the ultimate resistances to *tensile* strains of these two materials. Good iron plates, such as are used in the hulls of her Majesty's ships, have a tensile strength of from 40,000 to 50,000 lbs. (18 to 22 tons) per square inch of sectional area, the weight per cubic foot being 480 lbs. By means of careful tests this strength is secured in all the iron used; and it is a noteworthy fact that iron can be procured

of almost *constant* quality and strength. Taking this as the standard, let us see how the timbers chiefly used in ship-building compare with iron as to their tensile strengths in proportion to their weights. One feature in which all timbers differ from iron is in their want of uniformity of quality and tensile strength. Even when the utmost care has been taken to season timbers, considerable variations are found to exist, not merely in different logs, but in the strengths of different pieces cut from various parts of the same tree. Such causes as the existence of knots, cross-grain, &c. affect the strength; and it is very different lengthwise of the grain from what it is across the grain. Hence arises a difficulty in ascertaining the *average* strengths of timber materials, and one which is not easily surmountable; with the greatest care in the conduct of experiments, different investigators have reached very diverse results. Taking the best of these experiments, the following are the results for a few of the timbers most commonly used:—*

Timbers.	Average Weight per Cubic Foot.	Tensile Strength.
	Pounds.	Pounds per Square Inch.
British oak	54	7,600 to 10,000
Dantzic oak	52	4,200 to 12,800 ¹
Dantzic fir	36	2,240 to 4,480
English elm	35	5,500 to 13,500 ¹
Pitch pine	40	4,600 to 7,800
Teak	48	3,300 to 15,000 ¹
African oak	62	4,800 to 10,900
Sabicu	57	4,300 to 6,900

¹ Doubtful values; Mr. Laslett gives 5700 lbs. as the upper limit for teak, 7400 lbs. for Dantzic oak, and 6700 lbs. for elm.

* These figures are based upon the experiments of Barlow, Tredgold, Hodgkinson, and others, of which an excellent summary is contained in the late Professor Rankine's works, as well as upon the more recent and valuable experi-

ments recorded in *Timber and Timber Trees*, by Mr. Laslett, Admiralty Inspector of Timber. Sir W. Fairbairn's tables have also been examined in comparison with the others.

British oak may fairly be taken as the standard timber, and its weight per cubic foot is about *one-ninth* that of iron, while its ultimate tensile strength might be about *one-fifth* that of iron. Here, then, the timber apparently gains upon the iron in its ultimate strength compared with its weight; but it is easy to see that it does not really compare so favourably. First, the builder would have no certainty that any piece of oak he might select would reach the average of strength: it might fall so low as to be only one-eighth the ultimate strength of iron, some specimens tested having had that ultimate tensile strength. Second, to guard against possible defects not discoverable on the surface, and to meet the different range of elasticity, a larger factor of safety would be employed with the timber than with iron—about 10 for timber, as against 4 or 5 for iron.

As a simple illustration, take the case of a tie-bar of oak, say, 1 square foot in sectional area; it would probably have an ultimate tensile strength of about 570 tons, but would only be trusted with a moving load of about 55 to 60 tons. An iron bar of equal weight would have a sectional area of $\frac{1}{3}$ square foot, and a tensile strength of 320 tons; but, owing to its superior elasticity and the confidence felt in its uniformity of strength, it would be trusted with a load of from 65 to 80 tons. Or, to state the comparison somewhat differently, an iron bar capable of safely sustaining the same load as the oak bar need only have an ultimate tensile strength of, say, 260 tons, which would be equivalent to a sectional area of 13 square inches. The oak bar would weigh 54 lbs. per foot of length; the equivalent bar of iron would weigh about 45 lbs. per foot of length.

The same considerations apply to other timbers, oak being superior to most, if not to all of them: and in these considerations we find one of the explanations of the superiority of iron to wood in the combination of lightness with strength. Professor Rankine proposed $5\frac{1}{2}$ tons per square inch as the average ultimate tensile strength of ship-

building timber; but, in view of the more recent and extensive experiments which have been quoted, this estimate appears too high, and 3 tons per square inch would be sufficient allowance; 48 lbs. per cubic foot is about the average weight of these timbers.

Their ultimate resistances to compression also require consideration, in comparison with the resistance of wrought iron to direct compression.* Here authorities differ widely as to the strength of wrought iron. Professor Rankine gives from 27,000 to 36,000 lbs. per square inch; whereas Sir W. Fairbairn fixed it at 70,000 lbs., on the authority of Rondelet, the tensile strength being 45,000 to 50,000 lbs. per square inch. If the mean of the two statements is taken, it will be found that the ultimate resistance of iron to compressive strains is very nearly the same as its resistance to tensile strains, and this is probably very near the truth.

Taking the same timbers as in the list previously given, it appears from experiment that their ultimate resistances to compression are as follows:—

Timbers.	Compressive Strength.
	Pounds per Square Inch.
British oak	7,600 to 10,000
Dantzic oak	6,800 to 8,700
Dantzic fir	7,000 to 9,500
English elm	5,800 to 10,000
Pitch pine	6,500 to 9,800
Teak	6,300 to 12,000
African oak	10,000 to 11,000
Sabicu	6,500 to 9,000

A fair average value of the compressive strengths of timbers used in shipbuilding, therefore, appears to be about $3\frac{1}{2}$ tons per square inch, which nearly agrees with Professor Rankine's estimate. Against these strains, moreover, the use of so

* The iron is not supposed to fail by "buckling." See remarks on this subject at page 299.

large a factor of safety as against tensile strains scarcely appears necessary. Supposing a factor of safety of 8 to be taken instead of 10, the safe working load, on an average, for timber subject to compressive strains would be about *three-eighths* of a ton per square inch: for wrought iron, the working load would be from $2\frac{1}{2}$ to 4 tons—say, 3 tons as a safe average. As regards compressive strains, therefore, timber in single pieces compares better with iron, in strength relatively to weight, than it does in resistance to tensile strains. All pieces in a ship, however, are liable to both classes of strains, and consequently wood is inferior to iron, its inferiority becoming more marked when one passes from single pieces to a combination.

These factors of safety for both tensile and compressive strains have been determined chiefly from the practice of civil engineers, and are adapted to the conditions of fixed structures which have to bear the working loads frequently. There is an important difference between such structures and ships; for the latter have to resist the maximum strains (described in Chapter IX.) only on rare occasions, and probably at long intervals, the strains ordinarily experienced being much less severe. It will be evident that a severe strain only occasionally applied is not so likely to produce serious damage as a less strain frequently applied, especially when the character and intensity of the latter strain are continually and rapidly changing, provided that the maximum strain does not surpass the limits of elasticity of the materials. For these reasons, shipbuilders do not restrict themselves to the factors of safety approved by civil engineers. At present there are no recognised factors for the different classes of ships, but the subject is receiving attention, and from the analyses of the conditions of strain in numerous successful and unsuccessful ships there will probably be deduced, ere long, useful rules for practice corresponding to those of the civil engineer.

The moduli of elasticity of the two materials afford, perhaps, the readiest means of comparing their relative

resistances to both tensile and compressive strains. Professor Rankine gave the following values :—

Materials.	Modulus of Elasticity.
Wrought iron . . .	28,000,000
English oak . . .	1,450,000
Dantzic oak . . .	1,190,000
Dantzic fir . . .	1,958,000
English elm . . .	700,000
Pitch pine . . .	1,226,000
Teak . . .	2,400,000

More recent experiments made in the Royal Dockyards on some of these timbers give somewhat different moduli of elasticity. English and Dantzic oak, for example, had moduli of about 1,900,000—greater than those assigned by Professor Rankine; whereas teak had a modulus of about 1,300,000, or little more than one-half that in the above list. On the whole, however, it seems not unreasonable to accept the average modulus proposed by Professor Rankine, viz. that timber shall be considered to have about *one-sixteenth* the modulus of iron. When iron and wood act together, therefore, this is the ratio which should govern their equivalent sectional areas.* The ratio of weights per cubic foot, it will be remembered, is about 1 for wood to 10 for iron. No further remarks will be needed in illustration of the superior combination of lightness with both tensile and compressive strength, in single pieces of iron as compared with single pieces even of the best timber.

The resistance offered by a combination of pieces of timber to *compressive* strains does not compare less favourably with that of iron than does the resistance of a single piece of timber to that of a single piece of iron, provided

* See the remarks on page 315.

only that there is good workmanship in the fitting of the pieces together. This has already been explained in connection with the effective resistance to hogging strains offered by the lower parts of the wood ship illustrated by Fig. 102, page 322. A plain "butt" (or flat end) to two planks or timbers will effectively transmit a thrust, provided only that the two ends are well fitted to one another, and are prevented from changing their relative positions.

On the contrary, when several pieces of timber have to be combined in order to resist *tensile* strains, their resistance compares much less favourably with that of a combination of iron plates or bars than does the ultimate tensile strength of a single piece of timber with that of a single piece of iron. Against tension a butt-joint is obviously quite ineffective: for in Fig. 102, if any two timbers abutting on one another in a rib or frame were considered to act alone, and to be subjected to a strain tending to separate the butts, they could oppose no resistance except the friction of the dowel, which would be very trifling. If a "strap" of wood or iron were fitted over the butts and bolted to the timbers, it would resist the force tending to open the butts; and it has been shown that the weakness of the butts in any rib is, so to speak, covered by the strength of the unbutted ribs lying on either side. In many wood ships the timbers of consecutive ribs are bolted together, in pairs, to increase the strength of the frame. In the case of the water-way fitted upon the beam-ends of a wood ship (Fig. 102) the various pieces are plain-butted; but the butts are covered by strong carlings fitted underneath, and to these the water-way pieces are dowelled. This is an exceptional arrangement, however, the almost universal plan adopted where two pieces of timber have to be joined end-to-end, in order to form a tie, being to "scarph" or overlap the ends in some fashion more or less complicated and expensive.

Take the keel, for example, in a wood ship: the adjoining pieces are secured by what is termed a "tabled scarph."

Fig. 107 shows the two parts of the scarph, thrown back to exhibit the projecting "tabling" and the sunken recesses into which the tabling fits. Fig. 108 shows the two parts in place, with the fastening bolts which assist the tabling in resisting tensile strains tending to open the

FIG.107

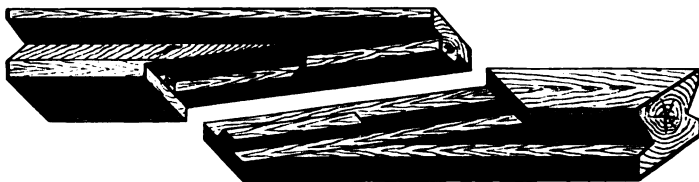
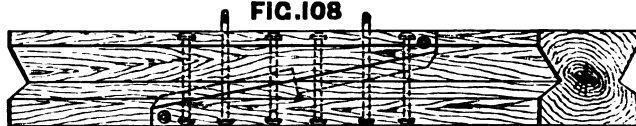


FIG.108



scarph. The plan is an excellent one, but necessitates considerable skill and cost of workmanship in fashioning the scarphs so that they may fit accurately. The same thing is true in the beam-scarphs, illustrated in side view by Fig. 109, and plan in Fig. 110. This is termed a "hooked

FIG.109

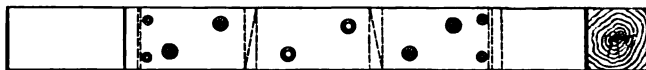


FIG.110



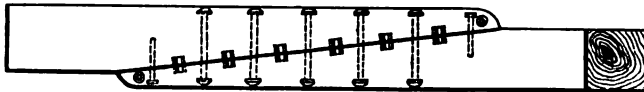
scarph," metal wedges or keys (k, k , Fig. 110) being driven to tighten up the scarph, and bolts and treenails being used to fasten it. This hooked scarph is of comparatively recent introduction, having replaced the simple but less compact and satisfactory method illustrated in Figs. 111 (side view) and 112 (plan). The fastenings in this case consist of dowels, treenails, and metal bolts. Still

another method of scarphing is illustrated in Fig. 113, and is known as a "plain scarph," being free from tabling and hooks. It is not nearly so strong against tensile strains as the preceding plans; but neither does it involve such care and expense in fashioning. The keelsons, shelf-pieces, and some other longitudinal ties, are frequently scarphed in

FIG.111

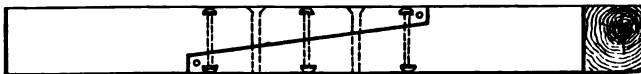


FIG.112



this manner. It will be noted that in the last plan, and the preceding one (Figs. 111, 112), the fastenings have to contribute the whole resistance to separation of the scarph under tensile strains; and when these strains are acting, there is a tendency for the wood to yield in wake of the comparatively small and hard metal bolts.

FIG.113



The greater hardness and small size of the metal fastenings in a wood ship is one fruitful source of weakness and working. Parts, at one instant under tension, tend to yield in wake of iron or metal bolts: soon after, under compressive strains, the tendency disappears, to be followed almost immediately by its reappearance, if the ship is floating amongst waves. It will of course be understood that we are here dealing with tendencies only, and not with actual yielding; the existence of a large reserve of strength often preventing the tendency from passing into a sensible change of form. When ships are weak, it is otherwise, and then working takes place. It is worth notice, in

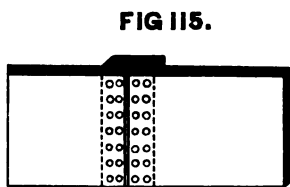
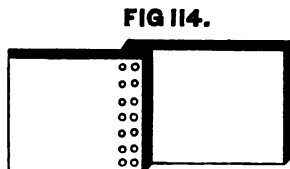
passing, that the use of timber treenails as fastenings in the outside planking of a wood ship, or of coaks and dowels, also of hard wood, is from this point of view a considerable advantage. Coaks in particular, and treenails in some degree, have a larger "bearing" surface on the wood planks, &c. than have metal bolts; besides which they are not so hard, both of which differences tend to lessen the local yielding of the pieces fastened by them.

An assemblage of wood planks or timbers, such as is found in the outside planking, or the flat of a deck, is not usually dealt with by scarphing adjoining pieces together. Plain butt-joints are then had recourse to (see Fig. 100, p. 315), and the weakness of the butted strakes on any transverse section is met by the device, previously explained, of "shift of butts." This is, however, tantamount to a reduction of the total sectional area by *one-fourth*, when resistance to tensile strains is being considered; and the holes for bolts and treenails necessitate a further deduction.

Such are the best results obtained either in timber-ties (like the keel, or beam, or shelf-piece) or in an assemblage of planking. Either scarphing of an elaborate and expensive character must be adopted, or shift of butts must be trusted. In all cases, moreover, the greater hardness and small surface of the metal bolts tend to produce yielding of the wood in wake of them when the parts are under tension.

In every one of these particulars iron gains upon wood. The rivets forming the fastenings of piece to piece are of the same degree of hardness as the plates or bars; so that yielding in wake of them is not to be feared. What must be secured is that the riveting is properly done, and the holes in the plates, &c. well filled by the rivets. Again, when two pieces of iron have to be joined to form a tie, nothing can be simpler than the connection. The pieces may either be lapped and riveted, as in Fig. 114, or butted and strapped, as in Fig. 115. In either case the shearing strength of the rivets may be made to fix the ultimate resistance of the tie to tensile strains. With the lap joints of Fig. 114

the resistance to compression is also measured by the shearing strength of the rivets; whereas in Fig. 115, if the butts are carefully fitted, the rivets in the straps need not sustain any shearing strain under compression, so long as the plates are prevented from buckling. It is usual in iron ships to have butts for the vertical joints of the outside plating, the transverse joints of the deck plating, and other important parts; but the edge joints of the outside plating, which are not subjected to great tensile and compressive strains, are usually lapped, and the edges of the deck plating are sometimes treated similarly.



The butts in a strake of plating are not necessarily sources of weakness, as are the butts in a strake of planking, because the butt-strap gives great tensile strength to the butts, and may be made to render the section of the plating in wake of a line of butts quite as strong as its section in wake of the lines of rivet-holes at adjacent transverse frames.* Shift of butts is had recourse to also in assemblages of plating, but is of less importance than in assemblages of wood planking. On the whole, in a well-built vessel, the effective sectional area of an assemblage of plating against tensile strains is probably not far from *seven-eighths* of the total sectional area, as compared with *five-eighths* for the skin of a wood ship. It is unnecessary to repeat what was said respecting the further gain of the iron skin, on account of the efficient edge connections of strake with strake,† although this is an important advantage.

Enough has been said to show that it is no exaggeration

* See a paper contributed by the Author to the *Transactions* of the Institution of Naval Architects for

1873. The subject is too technical to be discussed in these pages.

† See page 337.

of the merits of iron to say that whether in single pieces, or in simple ties, or in assemblages of numerous plates, it stands far above wood in its resistance to tensile strains. When exposed to compressive strains there is an undoubted danger of thin iron plates failing by buckling; but this can only happen in an ill-designed ship; the danger is easily guarded against, and when the plating is stiffened by some simple frame or girder, it will compare most favourably with wood in its resistance to compressive strains. A remarkable illustration of failure in an iron ship, by the buckling of her thin plating under compressive strains, is found in the steamship *Mary* (mentioned at page 312). Mr. John has carefully investigated the case, and has favoured us with the particulars of his calculations. From these it appears that the topside and deck plating were not sufficiently stiffened for the voyage, and consequently buckled when the ship was astride the wave hollows, their failure bringing upon the more rigid parts of the upper works an excessive strain, which caused the ship to break nearly amidships.*

Respecting the third class of strains, those due to bending moments, it is only necessary to add a few words. When a bent beam fails, fracture, as already explained, usually begins either at the upper or lower surfaces. If one of these surfaces is stretched, the other is compressed, and *vice versa*: failure therefore results from the excessive tensile or compressive strains brought upon the bounding layers of material. And for our purpose it will be sufficiently near the truth to assume that the resistance of these layers in the bent beam is very nearly equal to the resistances to direct tension or compression previously stated. It is undoubtedly a fact that in solid beams, like those of wood, of rectangular cross-section, the intimate connection of the parts with one another does somewhat affect the resistance of the bounding

* Mr. John's able and interesting investigation will appear in the *Transactions* of the Institution of Naval Architects for 1877.

layers. For example, Professor Rankine gives the following values :—

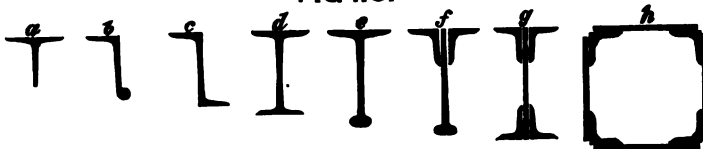
Timbers.	Strengths in Pounds per Square Inch.		
	Tensile.	Compressive.	Breaking.
Dantzic oak	12,780	7,720	8,740
Jamaica mahogany	8,800	16,600
Pitch pine	7,800	..	9,800

Such considerable differences are, however, the exceptions rather than the rule, and do not appear in the timbers most used.

With the flanged forms obtainable in wrought-iron beams, similar variations are not likely to occur, and there is no sensible error in assuming that the ultimate resistances of the flanges correspond to the tensile and compressive strengths obtained by direct pull or thrust.

A few examples of the great variety of forms in which iron beams are made will be found in Fig. 116. It is unnecessary

FIG 116.



References.

- | | |
|----------------|---------------------------------|
| a, T-iron. | f, bulb-plate with angle-irons. |
| b, angle-bulb. | g, made-beam. |
| c, Z-iron. | h, box-beam. |
| d, H-iron. | |
| e, T-bulb. | |

to repeat what has already been said as to the increased strength to resist bending obtained by using these flanged forms, instead of the solid rectangular sections which are

unavoidable with wood.* But it may be proper to mention that this essential difference between wood and iron affects the relative efficiencies not merely of deck beams, but also of ribs, longitudinal frames or strengtheners, pillars, and many other parts of the structure of a ship.

The simple angle-iron is sometimes used as a beam; its form may be seen from the sections *f*, *g*, *h*, in Fig. 116, and differs from the T-iron in having a top flange on one side only of the vertical web. Neither the angle nor the T form is well adapted for resisting bending strains, because of the absence of a bottom flange. The angle-bulb (*b*) is a great improvement in this respect, and is used for light decks or platforms. Z-iron (*c*) is used for frames behind armour in ironclads, and for longitudinal stiffeners, but not often for beams. H-iron (*d*) is expensive, and is not used so much as the made-beam (*g*) of similar cross-section. Not unfrequently, instead of having double angle-irons on the upper edge of the made-beams, to a deck covered with iron or steel plating, only single angle-irons are worked, a portion of the deck plating above the beam then forming the upper flange. Sections *e* and *f* may be regarded as interchangeable: the latter was formerly much in use, but since the iron manufacturers have made such advances as to be able to produce the section *e* with ease, and at moderate cost, the shipbuilder naturally prefers to obtain the finished form. The box-beam *h* is only used where exceptional strength is required, to support some concentrated load, or to furnish a very strong tie. Of the other sections sometimes used it is needless to speak; they all, or nearly all, exhibit the general characteristic of top and bottom flanges or bulbs connected by a thin vertical web. Even for the largest ships, beams of these sections are now procurable in one length, which is another great advantage as compared with the two-piece or three-piece wood beams required in large ships.

* See page 357 as to beams; also page 353 as to ribs.

A practical rule, not pretending to exactness, for comparing the strengths of beams may have some interest. For the flanged iron beams such as are generally used in ships, the ultimate breaking strengths of any cross-section may be expressed approximately by the formula

$$\text{Breaking strength} = 20 \text{ tons} \times \text{sectional area} \times \frac{\text{depth}}{3}.$$

The areas of the flanges being expressed in *square inches*, and the depth in *inches*, the breaking strength will represent a moment in *inch-tons*. For example, take a beam of section *d*, Fig. 116, suppose it 12 inches deep, and its top and bottom flanges to be each 6 inches wide, the web and flanges being $\frac{1}{2}$ inch thick. Then, approximately,

$$\begin{aligned} \text{Breaking strength} &= 20 \text{ tons} \times (12+6+6) \frac{1}{2} \times \frac{1}{3} \times 12 \\ &= 960 \text{ inch-tons.} \end{aligned}$$

For a solid wood beam of rectangular cross-section the approximate rule for teak or oak would be,

$$\text{Breaking strength} = 3 \text{ tons} \times \text{sectional area} \times \frac{\text{depth}}{6}.$$

The weight of the iron beam taken as our example would be about 40 lbs. per foot of length, the sectional area of a teak beam of equal weight would be about 120 square inches: suppose it to be 12 inches deep by 10 inches broad. Then

$$\begin{aligned} \text{Breaking strength (approximate)} &= 3 \text{ tons} \times 120 \times \frac{1}{6} \\ &= 720 \text{ inch-tons.} \end{aligned}$$

As regards ultimate strength, the iron beam is therefore one-third stronger than the wood beam of equal weight. But here the necessity for taking account of working strengths as well as breaking strengths must be remembered. The comparatively large factors of safety required with timber increases the advantage of iron, even when each beam is in a single piece. The scarphs of the wood beam further detract from its strength in wake of them. And,

moreover, it must not be overlooked that, while the strength of the iron (20 tons per square inch) may be safely looked for, the strength of the wood may vary over a very extensive range.

Putting the working strengths instead of the breaking strengths, the case stands approximately as follows :

Working strength of iron beam =

$$4 \text{ tons} \times \text{sectional area} \times \frac{\text{depth}}{3}.$$

Working strength of wood beam =

$$\frac{3}{10} \text{ ton} \times \text{sectional area} \times \frac{\text{depth}}{6}.$$

Weight of timber (per cubic foot) = (say) $\frac{1}{10}$ weight of iron.

Sectional area of timber beam = 10 times sectional area of iron beam of equal weight.

Hence, finally, for *equal weights* and *equal depths*,

$$\frac{\text{Working strength of iron beam}}{\text{Working strength of wood beam}} = \frac{4 \times 1 \times \frac{1}{3}}{\frac{3}{10} \times 10 \times \frac{1}{6}} = 2\frac{2}{3},$$

which represents a very considerable gain in favour of iron.

Besides being procurable in single pieces of a flanged form, iron plates and bars can be combined readily to produce that form ; on the other hand, wood must be used in rectangular or, at least, solid timbers, and cannot readily have many pieces combined into a flanged form. Examples of this difference have already been given. Refer, for instance, to the contrast between the solid timber ribs spaced closely in the wood ship (see Fig. 102, page 322) and the flanged transverse frames with the adjoining segments of plating in the iron ship (Fig. 103, page 324). As another contrast, compare the strong longitudinal frames or girders, to which the adjacent parts of the inner and outer skins form flanges in the ironclad ship (Fig. 104, page 331), with the solid binding strakes or keelsons of a wood ship. Many other illustrations of the facility with which iron can be thrown into the form best adapted for resisting bending strains will present themselves to the

student interested in the detailed structural arrangements: but we cannot now enlarge upon this important feature. Nor need we do more than recall attention to the fact that when the ship, as a whole, is treated as a girder resisting longitudinal bending moments, the component parts of the flanges in that girder are mainly exposed to tensile and compressive strains, in resisting which iron gains upon wood in the manner explained above; the web of the girder is simultaneously subjected to racking or distorting strains, against which the superior edge connections in an iron ship make the skin greatly more efficient than the skin of a wood ship.

From this brief sketch it will be understood why iron ships are lighter in proportion to their strength than wood ships of the same form and dimensions; as also why it is possible with iron to construct ships of sizes, proportions, and speeds unattainable with wood. It is, of course, possible by ill-considered structural arrangements to throw away much of the advantage that may be gained by using iron hulls. Bad combinations, improper distribution of the material, imperfect fastenings, and other faults may lead to the production of weak, yet heavy, iron ships. It has been shown in the preceding pages that even now, in the magnificent iron ocean steamships which lie so far beyond the possibilities of wood construction, all has not been done that might be accomplished towards associating lightness with strength. This statement, however, is only tantamount to an assertion that the capabilities of iron as a shipbuilding material have not yet been fully developed in the mercantile marine; and in support of this view we can refer to the remarkable results attained in the armoured ships of the Royal Navy, or the still more notable case of the *Great Eastern*.

Next, as to the comparative *durability* of iron and wood ships. For some years after the introduction of iron ships this was a matter of dispute, but lengthened experience

has settled it definitively in favour of iron. Ships properly constructed of that material, and properly treated during their service, suffer but little deterioration during long periods. Wood ships, on the contrary, even when constructed of well-selected and seasoned timber, and carefully used, are, as a rule, subject to comparatively rapid decay. Many examples may undoubtedly be found of great durability in wood ships, but these are exceptional cases; and, moreover, their occurrence has not put within the power of shipbuilders any means by which similar durability can be secured in other wood-built ships. For instance, the *Sovereign of the Seas*, built at Woolwich in 1635, is said to have been pulled to pieces forty-seven years later, the greater part of the materials having been found in such good condition as to be used in rebuilding her. Still more notable is the case of the *Royal William*, built about 1715, which remained on service for ninety-four years with only three slight repairs. Both these vessels were built of oak felled in the winter, and much importance was attached to this circumstance; but later experience in the *Hawke* sloop, built in 1793, threw some doubt upon the previous conclusion, the vessel having fallen into such a state of decay in ten years that she was taken to pieces.*

The very numerous schemes for preventing dry-rot and other kinds of decay in timber, which were proposed and tried prior to the introduction of iron ships, afford ample evidence that these cases of long-continued service were not common. These processes are now matters of history only, and will not be discussed; but there appears reason to believe that, on the whole, the best results, as to durability, were obtained with ships built of well-selected materials, which were allowed to season naturally, prior to being used in the ship, and after she was in frame.† This last-named condition

* See the remarks of Mr. *and Timber Trees.*

Ambrose Bowden, quoted by Mr. † It may be interesting to mention
Leslett at pages 68-70 of *Timber* that Lloyd's rules for wood merchant

of course involved slow progress with the construction of any ship, and was scarcely likely to have been fulfilled in the mercantile marine at any period; but in the Royal Navy, in the earlier half of the present century, it was frequently fulfilled, and some of the ships then built proved very durable.

With such varying conditions—depending upon the selection of the timber, the circumstances of its growth, the season when it was felled, the processes of seasoning, preservation, &c.—it will be readily understood that it is not an easy matter to assign the average durability of wood ships. Probably experience with ships of the Royal Navy prior to the general introduction of steam propulsion or the use of iron furnishes the best data for forming a just estimate; for the subsequent changes in *matériel*, from sailing to unarmoured steam ships, from these again to ironclads, and from wood hulls to iron, have all tended to introduce other conditions than those of fair wear and tear into the cessation of the service of wood-built ships. In 1841 Mr. Chatfield read a paper before the British Association, at Plymouth, in which he stated, as the result of careful examination, that thirteen years was the average time during which wood-built war ships remained efficient when employed on active service, and receiving ordinary repairs at intervals. Experience in the French navy points to a very similar term of service for wood ships. Moreover, the Rules for Wood Ships issued by the Committee of Lloyd's Register, and guiding the construction of by far the greater number of wood merchant ships, allow from twelve to fourteen years as the average period of durability to be assigned to the best descriptions of shipbuilding timber when properly seasoned and free from defects. Less satisfactory materials, used in subordinate parts of ships, or in vessels of inferior classes, have

ships strongly recommend the practice of "salting" the timbers, beams, &c.; and allow an additional year

of classification to vessels thus treated.

considerably shorter periods assigned, ranging so low as from four to six years.

Under the most favourable conditions, therefore, the average durability on active service of well-built wood ships, fairly used and kept in good repair, may be taken at from twelve to sixteen years. It has been shown that in some cases much greater durability has been obtained; and, on the other hand, many instances might be cited where vessels hastily constructed of unseasoned or unsuitable timber have fallen into decay in half, or less than half, the average time of service named. It is, of course, understood that the period of service is considered to expire when the cost of the repairs would be so heavy, if they were thorough, as to make it more economical to replace the worn ship by a new one. In the United States navy, for example, many wood vessels, built with the greatest possible rapidity during the Civil War, have been condemned after only six or eight years of service; while others, on which work has been suspended, have actually rotted on the stocks,* and will probably never be completed. The hurried construction, and use of any materials that could be procured, were undoubtedly the chief cause of the rapid decay; and on the other side of the picture may be placed the durability of the earlier screw frigates of the American Navy, which remained efficient for periods exceeding the average given above. Very similar results followed the hurried construction of the gunboats built for the Royal Navy during the Crimean War; they speedily fell out of service.

Recent experience with the wood ships of the Royal Navy may be quoted in support of the views expressed.† Taking the unarmoured wood ships, from frigates downwards, it appears that after ten to fifteen years of service they have reached such a condition as to render it impolitic to repair them.

* See published reports of the Secretary of the Navy. 297) of 1876, of Vessels Launched, Broken up, Sold, &c., from 1855.

† See *Parliamentary Paper* (No.

Special requirements have kept a few such vessels on service for longer periods; but no injustice is done to the class in fixing sixteen years as the general upper limit of durability for sea-going wood ships.

Ironclad wood-built ships are no longer-lived; in fact the conditions in these ships are, on the whole, less favourable to durability than they are in unarmoured ships. Nearly all the converted ironclads of the Royal Navy (*Caledonia* class) dating from 1861, but not actually on service until two or three years later, are now either on the Harbour Service List or else in such a condition as to render their repair inexpedient. So also is the *Lord Clyde*, which is about two years younger. In the French navy, also, very similar steps have been taken, the earlier wood-built ironclads having been struck off the effective list. The Italian navy furnishes still further examples, and so does the Austrian; but it is unnecessary to multiply illustrations of the comparatively speedy decay of wood ships. Even when all possible care has been taken in their construction, hidden sources of decay may exist in the structure, and sooner or later produce serious results. No certain length of service can be guaranteed under these conditions to any wood ship; and not unfrequently it happens that, in the examination of some apparently trifling defect, the discovery is made of much more serious and unsuspected decay, leading in some cases to the condemnation of the ship as unfit for further service. With iron ships the conditions are quite different, as we will now proceed to show.

Iron is not subject to those internal sources of decay to which timber is liable: nor is it subject to the attacks of worms or marine animals which can penetrate the comparatively soft planking; nor is it liable to rot in consequence of imperfect ventilation or other causes. Moreover, in a well-built iron ship there ought not to be any sensible working; whereas in wood ships, however carefully constructed, the connections and fastenings must, as we have shown, be less satisfactory; the entire prevention of working is practically impossible, and in such working is found a fruitful

source of weakness or decay. Corrosion or rusting of the surfaces is the special danger requiring to be carefully guarded against in iron ships; and it is by no means insignificant in its character. Both outside and inside, an iron ship is constantly exposed to conditions tending to promote corrosive action. The above-water parts of the hull are the least likely to suffer; but even these, on the outside, have to resist the effects of air, water, and weather, and in the inside are exposed to changes of temperature, the condensation of vapour, and other circumstances productive of rust, if left unchecked. The under-water parts of the hull are much less favourably situated. Outside, the bottom plating is immersed in corrosive sea-water; and inside, the plating, frames, &c. are to some extent exposed to bilge-water, often very corrosive in its character, to the chemical action of coal or other substances carried in the hold as cargo, and not unfrequently to galvanic action produced by metallic connection with pipes, &c., of copper, brass, or lead, immersed in the same bilge-water as the iron. Moreover, in steamers there are the great alternations of temperature in the parts adjacent to the boilers and engine-room, the condensation of steam upon the surfaces of the iron, and the production of gases more or less effective in aiding corrosion. Adding to these extraneous causes the generally admitted facts that in iron, such as is used for shipbuilding, the want of homogeneity in the various parts of the same plate or bar may cause corrosion to begin, or accelerate its progress; and that when rust has once formed it tends to propagate itself, eating deeper and deeper into the iron affected, it will be evident that watchfulness and precaution are needed to insure the preservation of iron ships. Their durability, in short, is not a result to be assumed as an intrinsic quality; but they differ from wood ships in this important feature:—with care and proper treatment they can, at moderate expense, be maintained in a sound and efficient state for very many years; whereas wood ships cannot be so maintained without an unwise outlay. The causes of decay in the iron ship lie upon

the surface, and are to a great degree preventible: those in the wood ship are deep-seated, difficult to discover, and practically incurable in the parts attacked. A corroded plate or bar can be scraped free from rust, cleaned and painted; and if corrosion has not proceeded far before such measures are taken, it is little or nothing the worse. On the contrary, a rotten timber or plank must be wholly or partially removed, often with very considerable difficulty. Neglect of preservative measures, of course, leads to the rapid decay of both iron and wood ships; but when the best is done for both, iron proves immensely more durable than wood.

General experience in mercantile and war fleets places this fact beyond dispute; but it does not yet enable one to fix an average of durability for iron ships, properly treated, corresponding to the average previously stated for wood ships. This is due, in part, to the comparatively short time that iron ships have been in general use: forty years or so, when contrasted with the lifetime of some existing iron ships, being a period too short to give data for fixing an average. Besides, it must be remembered that experience was necessary in order to determine what measures were best adapted to preserve iron ships, and what methods of construction most favoured such preservation. Even at the present time opinions on these matters are by no means unanimous. But certain points are settled which, at the outset, were uncertain, and in all probability the durability of ships built on these later methods—favouring the accessibility for inspection of all parts of the hull, and the isolation of the outer skin from many causes of corrosion by means of a double bottom—will prove greater than the durability of ships of earlier types. Hence the determination of the average durability of iron ships must be postponed to a later date.

Many of these early iron ships, however, proved very durable. Mr. Grantham records that the *Aaron Manby*, the first iron steam-vessel, built in 1821, lasted thirty-four years; the *Garry Owen* and *Euphrates*, river steamers, were in good order after twenty-four years' service; the *Nemesis* and

Phlegethon, the earliest iron war-ships built for the East India Company in 1839, were still at work twenty years after; and many other similar cases are known.

Turning to existing iron ships, no less notable results may be stated; but only a few can be given. The *Great Britain*, merchant steamer, was built in 1840, but is still afloat, and said to be strong and sound. In the Royal Navy the troopship *Simoom* is twenty-seven years old, but is still on active service. The *Himalaya* won golden opinions during the Crimean War, has been almost continuously employed since, and is quite as popular now as she was twenty years ago. The *Warrior* and other iron-built ironclads, dating from 1859-61, are yet strong and sound; whereas their wood-built contemporaries in the French and British navies have fallen into decay.* In the navy of the United States very similar experience has been obtained. The iron-hulled monitors which were on service during the Civil War remain on the effective list; but the wood-built monitors of later date have fallen into decay, and are being replaced by iron. Curiously enough, in some of these iron vessels wood beams were used, in consequence of the difficulty of procuring iron beams; and thus a very good illustration has been given of the comparative durability of wood and iron. The wood beams decayed after eight or ten years, and were then replaced, at considerable cost, by iron beams; the iron hulls meanwhile, although much neglected for a time, are said to have suffered no serious loss of efficiency.

Durability, in the sense we have used the term, is determined by the period which elapses before repairs become too expensive to be undertaken. Repairs to an iron ship are not

* Not unfrequently the great advantage possessed by the British ironclad fleet over that of France and other nations, in being mainly iron-built, and therefore very durable, is overlooked. Quite three-fourths of our ironclads are iron-

built; whereas in the French navy, until very recently, comparatively few ships were built of iron, and this is the only navy which in point of numbers can at all compare with our own.

nearly so difficult or expensive as in a wood ship; and therefore the limit of economical employment would not be so soon reached in the iron ship as in the wood, apart from the less rapid decay. On the other hand, the comparative thinness of the skin of an iron ship makes even a small loss of thickness important; and, what is perhaps of greater importance, corrosion is not uniform nor regular in its character over the whole surface of the bottom, but often becomes localised, "pitting" the iron plates in places. The rate of corrosion depends upon so many and such varying conditions that no general law can be assigned. For example, the same ship exposed to the action of differently constituted seawaters will be corroded at different rates. The existence of galvanic action also rapidly accelerates and localises corrosion; and two plates or bars of iron apparently similar in quality are often found to be very differently affected by corrosion, as are also different parts of the same plate or bar. It lies outside our present purpose to attempt any discussion of this subject beyond what has been done, but obviously the practical deduction to be drawn from this want of regularity in the rate of corrosion of iron ships is simply this:—to prevent serious corrosion, careful and frequent inspections are necessary of all parts of the hull, particularly of those situated below the water-line. Experience confirms the view that where such inspections are made, and the surfaces of the iron are kept protected by paint, varnish, or cement, the rate of corrosion may be made very slow. This broad general deduction is far more important than the deductions made from laboratory experiments on the loss of iron by corrosion under various conditions, although these experiments have a certain value.*

* Probably the best summary of such experiments yet published is contained in a paper contributed by Mr. R. Mallet, F.R.S., to the *Transactions* of the Institution of Naval Architects for 1872. Some

of the conclusions from those experiments stated by Mr. Mallet appear, however, scarcely consonant with the results of experience with iron ships.

The outer bottom plating of an iron ship, liable as it is to corrosion on both surfaces, furnishes one of the best tests of the possibility of lessening corrosion by the means just mentioned. In the ships of the Royal Navy, when undergoing thorough repair, it is usual, after they attain a certain age, to ascertain the decrease in thickness of the plating by careful drilling and measurement. When thus treated a few years ago, it was found that the *Simoom*, then over twenty years old, required only a small number of new plates in her bottom, by far the larger number of the plates having maintained sufficient thickness to be safely trusted for further service. It is also worthy of mention that as yet not a single bottom plate in any of the iron-built ironclads of the Navy has had to be renewed in consequence of corrosion, although some of these vessels have been afloat fifteen years. Lloyd's Rules, the highest authority that can be quoted for merchant ships, being based upon a very large range of experience, fully recognise the slow progress of corrosion in iron ships properly treated. Therein it is provided that, when an iron vessel is twelve years old, she is to be thoroughly surveyed, and all rust removed, the thickness of her plating being ascertained by drilling: where the loss in thickness exceeds *one-fourth* of the original thickness, new plates are to be fitted. Surveys made at intermediate periods are trusted to discover any local wearing or pitting, and it is not until another twelve years have elapsed that another searching investigation is required. No absolute limit is placed upon the period of service, the Rules providing that vessels will be classed "so long as on careful annual and periodical special surveys they are found to be in a fit and efficient condition to carry dry and perishable cargoes to all parts of the world."

Laboratory experiments upon the loss of thickness in iron plates subjected to the action of sea-water do not furnish trustworthy data from which to compute the durability of the bottoms of iron ships; and this for two reasons. The actual conditions of service in a ship cannot be represented, nor can all the variations in quality of the iron be tried. To state the

mean loss in thickness for a certain period, as already remarked, is very misleading, since local wear or "pitting" takes place, and may penetrate deeply into a small portion of a plate of which the general surface is but little worn. In iron vessels of considerable age it is not uncommon to find local patches of corrosion, at which the reduction from the original thickness of plates is twice or thrice as great as the average reduction. Galvanic action exaggerates local wearing: if a copper suction-pipe, for instance, dips into the bilge-water which lies upon the inner surface of the bottom plating, and this pipe and the plating are joined by ever so circuitous a metallic connection, galvanic action will be set up and the iron plate near the suction-pipe will waste. Cases are on record where by this means holes have actually been worn completely through the bottom of an iron ship, which in other respects was satisfactory; * but this kind of action is wholly preventible when proper precautions are taken. Pitting due to other causes is not wholly preventible, but it may be much lessened by careful selection of the iron plates used on the bottom, and by careful and frequent inspection, scraping, and painting of the surfaces.

To show how limited is the use of laboratory experiments, one example may be given. One careful experimenter (Mr. Mallet) estimated from his experiments that the mean loss in thickness of iron plates immersed in foul sea-water was rather over $\frac{1}{2}$ inch ($\frac{53}{100}$) in a century: two other careful investigators (Dr. Calvert and Mr. Johnson) reached the conclusion that the corresponding loss would be about $\frac{5}{8}$ inch ($\frac{61}{100}$). The mean result for all these experiments would therefore be $\frac{57}{100}$ inch as the loss of thickness in a century; which would be less than the actual thickness of the bottom plating of a large number of iron ships. As a matter of fact, however, many cases are on

* See, for example, the report on the case of her Majesty's ship *Supply*, published in the report of the Royal Commission on the loss of the *Megara*.

record where, without pitting, iron plates on the bottoms of ships have worn much more rapidly. In the *Megæra*, for example, when fifteen years old, many plates were found to have become reduced $\frac{1}{4}$ inch from their original thickness; and if this rate of wear had been maintained, the loss in a century would have been not much less than thrice as great as that given by the laboratory experiments. It is, of course, quite conceivable that under other conditions the wear in the *Megæra* might have agreed with the laboratory experiments; but neither such experiments nor actual results on ships can furnish any *general law* for the rate of corrosion.

The Regulations issued by the Admiralty for the preservation of iron ships contain the best summary of the precautions necessary for that purpose with which we are acquainted. As the circulars on this subject are generally accessible, it will be sufficient to summarise the main points. *Galvanic action* of copper, brass, or lead upon the iron hull is to be prevented by making the lower pieces of suction-pipes, &c., which are immersed in the bilge-water, of iron or zinc or zincked iron wherever that is possible. Where copper or brass pipes are unavoidable, they are to be well painted or varnished and covered with canvas in order to reduce their action on the iron. The gun-metal screw-propellers are also to be painted for the same reason, and bands of zinc, termed "protectors," are to be fitted near them, in order to concentrate the galvanic action of the propellers upon the protectors and save the bottom plating: this plan has answered admirably. In order to preserve the *inner* surfaces of the bottom plating below the bilge from the injurious effects of the wash of corrosive bilge-water from side to side as the ship rolls, cement is used, and has proved of great advantage to both merchant and war ships. Other surfaces of plates and bars in the interior are protected by suitable paints or compositions. All parts of the hull are ordered to be made as accessible as possible for inspection and repairs. In cases where parts are necessarily

inaccessible under ordinary circumstances—such as under the boilers or engines, &c.—careful records are to be kept of them; and when opportunity offers, as during a thorough repair at a dockyard, all such parts are to be opened up and inspected. When a ship is in the reserve or on service, all accessible parts are to be inspected once a quarter, cleaned and painted when necessary. Annually a more thorough survey is to be made, by dockyard officers when possible; and then the only parts to be left unvisited are those which cannot be reached without great difficulty—as, for instance, spaces which can only be attained by lifting the boilers or machinery. The use of double bottoms facilitates a thorough examination; especially of the inner surface of the outer plating, and all the parts of the inner plating underneath engines and boilers. The outer surface of the bottom plating is to be sighted at least once a year; it is protected by some anti-corrosive paint or composition, and if the annual examination shows it to be necessary, this protective material is renewed.

Such are the main points in the Admiralty Regulations. Conformity to them must prevent any serious corrosion taking place: for rusting ought to be detected in its earlier stages, and the surfaces, being frequently cleaned and coated, ought not to suffer greatly. The system has now been in force for some years, and has worked most satisfactorily. In a modified form it is applied also to the preservation of the ironwork in the composite ships of the Royal Navy.

Thirdly, iron ships gain upon wood in being more easily and cheaply built and repaired. Upon this division of the subject but few remarks will be necessary, although it has great practical importance.

Timber is only obtainable by the shipbuilder in pieces of which the forms and dimensions are limited by causes beyond his control; and the greatest care has to be bestowed upon the “conversion” of the logs, in order to get out of

them the best possible finished timbers. For some parts of a ship where the curvature is considerable—as, for instance, the ribs—it is not unfrequently a matter of difficulty to procure suitable timber. Even when a good choice has been possible, considerable labour and skill have to be expended on fashioning the pieces; and we have shown how difficult it often is to effect a good combination of piece with piece. Manual labour is, moreover, almost a necessity in the greater part of the work of building a wood ship.

Iron, on the contrary, is obtainable by the builder from the manufacturer almost of the sizes and forms required, the dimensions of the pieces and their sectional forms being limited only by the powers of the manufacturer, which continually increase as the demand increases. The progress already made is most remarkable, and there are yet no signs of the limit having been reached. Less than twenty years ago an armour plate which weighed 5 tons was considered heavy; now plates are commonly made weighing 20 or 30 tons, and plates of 40 or 50 tons can be produced if desired. Another example is furnished by the manufacture of wrought-iron beams. Formerly the sectional form *f* in Fig. 116, page 385, was largely used, and the section *e* was made with difficulty by a special process: now *e* can be rolled easily, even in the largest sizes. The section *c* also has replaced, to a large extent, a girder formed by a plate with a single angle-iron on each edge. But it is needless to further illustrate a well-known fact: the progress of the iron manufacture tends towards the production of finished sectional forms, and the avoidance of cost and labour in combining plates and angles to produce such forms.

In building an iron ship, less work is also required in fashioning and combining the pieces than is the case with wood. Beams, for instance, in the iron ship are given to the builder in one length: costly scarphs like those in Figs. 109 and 110 are unnecessary. Bending takes the place of the costly fashioning required for the curved pieces of a wood

ship. Welding, lapping, and butt-strapping replace scarfing. And, what is no less important, machinery can be, and is, extensively employed in the preparation of the parts of an iron ship.

Any one who has witnessed the rapid progress on the framing of an ordinary iron ship, as compared with that on the erection of the ribs of a wood ship, cannot fail to have noticed the much greater simplicity of the operations required in the iron ship. And although in a vessel built on the longitudinal system of framing (see Fig. 104, page 331) the operations of construction are less simple than those in an ordinary iron ship, yet even here all that has been said above applies; individual pieces are procured of the forms and dimensions desired, they are combined simply, and the work admits of being pushed on rapidly.

Iron ships are also much more easily repaired. All, or nearly all, the surfaces of the skin-plating, as well as those of the transverse and longitudinal framing, in these ships may be, and should be, made easily accessible for inspection: for which purpose it is highly desirable that the inside planking (or "ceiling") should be arranged in such a manner as to be readily removed. In case of damage, therefore, the injured parts can usually be reached, examined, and replaced without any great difficulty. Wood ships, on the contrary, are not so readily examined or repaired. The various parts are so closely associated, interlaced, overlapped, and fastened, as to render a considerable disturbance unavoidable if any considerable repair is needed. It is, for example, a task of some difficulty and expense to replace a rotten timber in the framework by a sound one, and when a vessel has been aground and had her bottom seriously damaged, the cost and difficulty of the repair must be considerable.

From many notable examples of the ease with which the repairs of iron ships may be effected, a few may be selected. The *Great Britain* was for many months ashore in Dundrum Bay, and although the bottom was battered by beating upon the rocks, and the boilers were forced up about 15 inches,

yet the damage was almost confined to the lower part of the hull, her form remained unaltered, and she was got off and repaired. The *Tyne*, an iron steamer, ran ashore on the south coast, and remained for several months in an exposed position; but she too was ultimately floated and repaired, being made as strong and sound as ever, although a large portion of her keel had been torn off and her floor much injured.* The *Great Eastern* furnishes still further proof of the ease with which an iron ship can be again made efficient after serious damage to her bottom;† and in the Royal Navy one meets with similar cases. The *Agincourt* was easily repaired after running on to the Pearl Rock; and the *Bellerophon* and *Northumberland* were again restored to efficiency without large expenditure after being injured by collision. Still more remarkable are the cases, of which several have been brought to our knowledge, where iron ships which have grounded and broken in two, have subsequently been floated, the separated parts reunited, and the ships again employed successfully. We regret that limited space prevents any details being given of these occurrences.

Further, iron ships, under the ordinary conditions of service, require much less expenditure on repairs than wood ships, in order to meet wear and tear. This is a matter not admitting of question. It is, of course, difficult to speak with certainty as to the comparative costs; but probably it is within the truth to say that, on an average, the deterioration in a wood ship is not far from twice as great as that in an iron ship, in equal times, and under similar conditions of service. The usual allowance for wood ships is that in from twelve to fifteen years the casual repairs to

* Mentioned by Mr. Grantham in his work on *Iron Shipbuilding*. Much interesting information respecting the accidents to the *Great Britain* and *Great Eastern* will be

found in the *Life* of Mr. I. K. Brunel.

† See the remarks on page 33 as to the accident to that ship.

meet ordinary wear and tear of the hull, apart from accidents, would about equal the first cost; for iron ships the corresponding term would probably be twice or thrice as great. The Parliamentary Returns for the Royal Navy confirm this view, only the figures given represent total outlay upon maintenance, repair, and alterations in the hull; machinery, armament, &c., and therefore tell against the iron hull considered separately. This being understood, the following figures will be interesting. During the eight years 1866-74 over £124,000 in all was spent upon the maintenance and repair of the *Warrior*—a large sum, doubtless, but corresponding to an average annual outlay of about *one-twenty-fifth* part only of the first cost—although this period represented what would have been the latter half of the average life of a wood ship. The same proportionate outlay occurred also in the *Defence* and *Resistance*, which, like the *Warrior*, date from 1859-60. Ships of less age, of course, cost proportionately less. The *Bellerophon*, for instance, in these eight years, being new, only had spent upon her annually, on an average, about *one thirty-third* part of her first cost, and this included repairs after her collision with the *Minotaur*. In their first five years of service the *Invincible* class cost annually only about *one-eightieth* part of their first cost. While these examples are not exactly to the point, they furnish a confirmation of the views expressed above; for the boilers and machinery are subject to greater wear and tear than the hull, and the cost of alterations in fitting or equipment is not fairly chargeable to repairs.

The relative first cost of constructing wood and iron ships is a matter upon which it is not easy to pronounce definitely. Some authorities have estimated that in merchant ships the saving by using iron instead of wood must amount to quite 10 per cent.: others have asserted that, on the whole, in iron sailing-ships merchandise can be carried at least 25 per cent. more cheaply than in wood ships of equal size. But obviously the relation between the first costs is not the sole,

nor even the chief, condition in the determination of the relative economies of the two classes of ships; and the changes in the prices of materials from time to time must greatly influence that relation. For example, when iron was so dear a few years ago, wood sailing-ships of moderate size were much in request because they were cheaper than iron ships: but even under those unusual conditions no attempts were made to reinstate wood in the construction of the largest sailing-ships, much less in that of steamers. In short, as has been previously said, it is a question of the *possibilities* of the two materials which has determined the shipbuilder to abandon wood: with iron he can achieve results not attainable with wood, and he would be justified in incurring greater first cost in building iron ships, even were that additional expense necessary. In proportion to their commercially remunerative powers, iron ships are not dearer than wood; and in judging of these powers, one has to consider, besides first cost, the durability of the structure, probable expense of repair and maintenance, carrying-power for cargo, &c. In war ships, instead of cargo, there have to be carried weights of armour and equipment; and it is quite conceivable that, to gain a permanent superiority in this carrying-power, it would be really economical in the end to incur a greater first cost. These considerations apply with greater force to the comparison of steel and iron ships than they do to that of iron and wood ships, as will appear farther on.

The last feature of superiority in iron ships to which reference will be made is their *greater safety* when properly constructed. Against all ordinary risks of foundering at sea iron ships may be secured by efficient watertight subdivision, such as has been described at length in Chapter I. It has there been remarked that in very many cases other considerations are allowed to override those of safety; iron ships being built with so few bulkheads as to be practically destitute of any provision against foundering, other than the

strength of the skin-plating and the decks. But this failure to introduce bulkheads, in order to obtain large cargo-holds, of course detracts in no measure from the possible safety of iron ships. Much the same may be said of the doorways and other openings cut in the bulkheads for convenience of passage from one compartment to another: these openings may be provided with watertight covers, but if they are not closed when accidents happen, the efficiency of the system of subdivision obviously ought not to be discredited in consequence. Again it is possible, either by defects of workmanship or by wear and tear in service, for a partition presumably watertight to be really not so: such defects are, however, easily discovered by testing, and are not difficult to remedy.

All that need be said, therefore, on this head is, that when the internal space of an iron ship is subdivided into numerous compartments by longitudinal or transverse partitions rising to a sufficient height, or by horizontal platforms, or an inner skin, and all such partitions are really *watertight*, then that ship is safer than any wood ship would be against foundering.

It is needless to quote instances of the insufficiency of the subdivision practised in most iron merchant ships: they are, unfortunately, of too common occurrence; accidental, and perhaps slight, collision leading to the rapid sinking of one or both of the ships. The ill-fated troopship *Birkenhead* is a case wherein the original subdivision was satisfactory, but was marred by cutting openings in the partitions, in order to make more easy the passage from compartment to compartment in the hold. In the *Vanguard*, according to the evidence given at the court-martial, the doors in some of the bulkheads were open when the ship was struck by the *Iron Duke*, as they naturally would be under the circumstances; although, had the ship been expecting a collision, as in action, the doors would either have been closed or held in readiness for closing. Some difficulty was experienced in closing the doors in the *Vanguard*, and the results were

very serious, as the steam-pumps could never be brought into operation. Finally, as a case where the watertightness of a partition proved of great importance, reference may be made to a case which happened some years ago. On survey it was found that the bulkheads of a steamer were not watertight; and they were ordered to be made so. Almost immediately after, the vessel was struck by another, and seriously damaged on the fore side of a bulkhead, which had been caulked, the watertightness of which prevented any passage of water farther aft, and the vessel kept afloat, bringing her passengers and freight safely into harbour.

Bulkheads in iron ships have also proved themselves of great value against fire. The well-known case of the *Sarah Sands* illustrates this. The nature of the material in their hulls gives to iron ships a greater degree of safety from fire than wood ships; although the existence of wood decks, inside planking, fittings, &c., somewhat detracts from this superiority. In the *Sarah Sands*, when employed as a troopship, and far away from land, a serious fire in the after part of the ship was kept from spreading by the existence of a bulkhead, upon one side of which cold water was thrown in large quantities; and although the vessel was much damaged, she was kept afloat and the lives of those on board were saved, which could scarcely have been hoped for had such a fire broken out in a wood ship.

Turning to the other side of the picture, brief reference must next be made to the *disadvantages* attending the use of iron ships. These are twofold: easy penetrability of the thin bottom by any hard pointed substance, and fouling of the bottom. Respecting the former, it is only necessary to refer to the remarks made in a previous chapter (page 298), and to add that the use of a double bottom completely overcomes the difficulty, while it would be unwise to attempt to meet it, as some persons have suggested, by greatly increasing the thickness of the outer bottom plating.

Fouling is a much more serious drawback to the use of iron ships. Wood ships with copper sheathing on their bottoms can keep the sea for very long periods with a comparatively small increase in resistance, and loss of speed, due to their bottoms becoming dirty. Iron ships, on the contrary, even when their bottoms are covered with the best anti-fouling compositions yet devised, cannot usually remain afloat more than a year without becoming so foul as to suffer a serious loss of speed; and very frequently a much shorter period suffices to produce this condition. The prevention of fouling has naturally attracted much attention; numberless proposals having been made with the object of checking the attachment and growth of marine plants and animals, which goes on more or less rapidly on iron ships in all waters, and especially in warm or tropical seas. Various soaps, paints, and varnishes of a greasy character have been proposed for the purpose of rendering the attachment of these marine growths difficult, and of securing a gradual washing of the bottom when the ship is under weigh. Many others have been suggested having for their common object the poisoning or destruction of these lower forms of life. Sheets of glass, slabs of pottery; coatings of cement, enamelling, and many other plans for giving a smooth polished surface to the bottom, in order to prevent the adhesion of plants and animals, have been recommended, and in several instances tried, but not with much success. In fact, it would be difficult to point to any other subject which has been made the basis of so many schemes and patents, with so little practical advantage. Between 1861 and 1866 over a hundred plans were patented for preventing fouling, and in the subsequent period inventors have been quite as busy; but no cure for fouling has yet been devised, the best compositions in use are only palliatives, and the question remains much in the same position as it did fifteen or twenty years ago.

A distinction must be made between *corrosion* and *fouling*. The former, with frequent inspection, cleaning, and painting of the outer bottom plating, can be made very slow; and this

course is not merely advantageous in preserving the structure, but has the effect of reducing the tendency to fouling. Neglect of precautions against corrosion has the effect of making fouling more rapid. Some persons even go so far as to affirm that if all *rusting* were prevented on the bottoms of iron ships, they would be free from fouling; and that if a smooth, clean surface could be maintained, the plants and animals would not attach themselves. Some serious objections to this view may be urged; but it is needless to dwell upon them, since the conditions laid down can never be fulfilled in practice on the bottom of an iron ship, subject to blows, abrasions, and all the wear and tear of service, besides being almost constantly immersed in corrosive sea-water. All iron ships with unsheathed bottoms become foul in a comparatively short time; and cases are on record where a few months in tropical waters have sufficed to produce such an amount of fouling as to reduce their speed by one-half. Under ordinary conditions, if an iron ship can be docked and have her bottom cleaned and re-coated once or twice a year, all goes well; but longer periods afloat induce an objectionable amount of fouling.

Hence it is that vessels intended for cruisers in the Royal Navy, as well as special vessels in the mercantile marine, intended to keep the sea for long periods and to maintain their speed, have been either constructed on the composite system, or else had their iron hulls sheathed over with wood planking and covered with some metallic sheathing, such as copper, Muntz metal, or zinc. The clippers which were formerly employed in the China tea-trade, and whose annual races home attracted so much notice, were built on the composite system, resembling iron ships in all respects except that they had wood planking, keels, stems, and sternposts, and had their bottoms copper-sheathed. These vessels could lie in the Chinese ports unharmed, under conditions which produced very objectionable fouling in iron ships. In the Royal Navy at the present time the composite system of construction is applied to vessels up to the size of corvettes;

the outside planking being worked in two thicknesses and the bottoms copper-sheathed. For larger and swifter cruisers, such as the *Volage* and *Inconstant* classes, the use of an iron skin becomes a necessity in connection with the provision of structural strength; and in most of these vessels copper sheathing has been adopted, two thicknesses of wood planking being interposed between the sheathing and the iron hull. Two of the ironclads of the Royal Navy, the *Swiftsure* and *Triumph*, have also been built on a similar plan. It has now been thoroughly tested during seven or eight years, and has proved satisfactory; but it involves some special dangers, and it is a very expensive method of construction, so that endeavours have been made to substitute zinc for copper, and one thickness of wood for the two formerly employed. The *Audacious*, at present flag-ship on the China station, was thus sheathed some six or seven years ago; and the experiment proved sufficiently successful to procure further trials of zinc sheathing in two or three other vessels, some of which are now on service. But the matter must still be regarded as in the experimental stage.

The anti-fouling properties of copper sheathing are due to the fact that the action of sea-water upon its surface produces oxychlorides and other salts which are readily soluble, and do not adhere strongly to the uncorroded copper beneath. Hence the salts, instead of forming incrustations, are continually being washed off or dissolved away, leaving the sheathing with a smooth, clean surface, and preventing the attachment of plants or animals. Some chemists have attached importance also to the poisonous character of the salts of copper in preventing fouling; but the foregoing is undoubtedly the more important feature, and is commonly termed "exfoliation" of the copper. The rate at which this wasting of the copper proceeds varies greatly under different circumstances, and with different descriptions of copper; and formerly this subject received much attention, the aim being to secure the minimum rate of wearing consistent with

the retention of anti-fouling properties. For this purpose Sir Humphry Davy suggested to the Admiralty the use of "protectors," formed of iron, zinc, or some metal electro-positive to copper. When these protectors were put into metallic connection with the copper sheathing and immersed, galvanic action resulted, the protectors were worn away, and the rate of wearing of the copper was decreased in proportion to the ratio of the surface of the protectors to the surface of the sheathing. When the protector had about $\frac{1}{100}$ of the surface of the sheathing, there was no wasting of the copper: with a smaller proportionate surface of the protectors the copper wasted somewhat; but even when the protectors had an area only $\frac{1}{1000}$ part that of the sheathing, there was proved to be a sensible diminution in the rate of wearing. The limits of protection from fouling appeared to be reached when the surface of the protectors equalled $\frac{1}{30}$ part of the surface of the sheathing. After experience on actual ships it was found, however, that preservation of the copper by this means led to rapid fouling, and the plan was abandoned. Nor has any substitute been since found; the practice being to exercise great care in the manufacture of the copper, and to regard its wasting as the price paid for preventing fouling. Muntz metal—an alloy of copper and zinc in the proportions of about 2 to 3—has been used largely as a substitute for copper, especially in the ships of the mercantile marine, and appears to answer fairly well, being, of course, much cheaper than copper. Such alloys are supposed by some persons to have the advantage of not producing powerful galvanic action upon iron immersed in sea-water and metallicly connected with them; but this property has not been definitely established. On the other hand, it appears that, after being long immersed, the alloy tends to alter in composition. Muntz metal sheets have been found to become brittle after being some time in use; and the explanation given is that, the zinc being electro-positive to the copper, galvanic action is established between the two metals in

the alloy, and part of the zinc removed. The introduction of a third metal, such as tin, is said to prevent this objectionable change, even when it is present in very small quantities.

Zinc is another material largely used for sheathing the bottoms of wood ships. When immersed in sea-water, the salts formed on the surface of a zinc sheet are very much more adherent to the uncorroded zinc than are the corresponding salts of copper, and are comparatively insoluble—or perhaps, we should say, are slowly soluble—by ordinary sea-water. Hence it appears that a coating of oxychloride of zinc, &c., is likely to form on the sheathing, not being washed away or removed like that on copper; and consequently zinc does not possess such good anti-fouling properties as copper, nor present such a smooth surface. But it answers fairly well, and lasts for a considerable time under ordinary conditions. In some waters, however, and those of the tropics especially, zinc sheathing has been found to perish very quickly, owing probably to such a composition of the water as favoured the rapid solution of the salts formed on the surface, the exposure of the uncorroded zinc, its rapid oxidation, and so on. Sir John Hay records that, in the *Trinculo*, one commission on the African coast sufficed to strip the bottom of zinc and leave the wood exposed, fouling of course ensuing. Other cases are reported where zinc sheets $\frac{1}{8}$ inch thick have, under exceptional conditions, been worn through in the course of twelve months.

Under ordinary conditions, zinc sheathing is much more durable: in fact, to increase its anti-fouling qualities, it is often put into communication with some metal, such as iron, which is electro-negative to itself, in order that the galvanic action which is produced may have the result of keeping the surface of the zinc freer from incrustations to which marine plants and animals can adhere. Apart from this, it may be interesting to give the relative losses sustained by copper, zinc, Muntz metal, iron, and steel, when suspended in the

sea for purposes of experiment by Dr. Calvert Johnson.*

Metals.	Loss of Weight per Month on each Square Foot of Surface.	
	In a Vessel of Sea-water.	In the Sea.
	lb.	lb.
Copper	0·0027	0·0061
Muntz metal	0·0015	—
Zinc	0·0012	0·0070
Iron	0·0056	0·0204
Steel	0·0060	0·0216

These results are open to some doubt when applied in estimating the probable loss occurring during periods of immersion in sea-water of various qualities; they are valuable for purposes of comparison between metals, and between the case of immersion in a vessel of water, and in the sea itself, where there are many circumstances tending to remove the salts formed on the surface. It is a fact that there are greatly different rates of wearing in different seas; it is of common experience; and the experiments made by R. Mallet, F.R.S., furnish some valuable information on this head.† Iron boiler plates which lost from 0·007 lb. to 0·012 lb. per square foot per month in *clear* sea-water, lost about as much in foul sea-water. With steel, very similar results were obtained.

Wood ships are protected from fouling by nail metal sheathing directly upon the wood planking; iron ships cannot be protected in quite so simple a way, the iron sheathing having to be attached in a manner depending upon its position in the galvanic scale relatively to the wood.

* See the *Transactions* of the Literary and Philosophical Society of Manchester for 1865, quoted at page 199 of *Shipbuilding, Theoretical and Practical*.

† See reports of British Association, 1841-43; also volume 1 of the *Transactions* of the Institution of Naval Architects.

upon its anti-fouling properties. Copper sheathing, for example, may produce serious galvanic action upon the iron hull, or portions of the hull, if there is intimate metallic connection between the sheathing and the iron; and even a very indirect metallic connection will suffice to produce some action. Muntz metal, again, is electro-negative to iron, and therefore requires to be insulated. Zinc, on the contrary, being electro-positive to iron, need not be insulated from it; but since the rate of wasting required to prevent fouling of the zinc is practically governed by the amount of galvanic action set up on its surface by the iron, considerable care is needed in adjusting the relative surfaces of the two materials subjected to galvanic action. A brief description will suffice to show what has been done in practice to overcome these various difficulties.

Ships of the Royal Navy built of iron, or on the composite principle, and copper-sheathed, have two thicknesses of wood planking interposed between the copper and the iron portions of the hull. The inner thickness is bolted to the skin-plating or to the iron frames; the outer thickness is bolted to the inner, the bolts not being allowed to come into contact with the iron of the hull, nor with the bolts of the inner thickness. Wood stems and sternposts are fitted in many of the composite vessels; but in the swift cruisers and ironclads brass stems and sternposts are employed. The copper sheathing is not brought into contact with the metal stems or sternposts, nor with the metal kingston-valves, &c., passing through the bottom; and by these means it is endeavoured to insulate the copper from the iron hull. Doubts have been expressed as to the sufficiency of these precautions, it being supposed that there must be some metallic connection between the hull and the copper, resulting in corrosion of the iron. It will suffice to say in reply that the precautions taken at least prevent any powerful local action, such as might otherwise take place in the neighbourhood of the fastenings. In fact, after seven or eight years' experience with the sheathed ships of the

Inconstant and *Volage* classes, including service on very distant stations and in tropical waters, no signs of serious galvanic action or corrosion have been discovered upon careful examination. Further, the copper sheathing has well maintained its anti-fouling properties, which it could scarcely have done if it were causing much galvanic action on the iron hull.

One special danger is necessarily incurred by such ships, and ought not to be passed over. Any damage to the bottom, which stripped off the bottom planking and exposed a portion of the iron skin, would necessarily place that portion of the skin within the influence of powerful galvanic action: for it would be immersed in the same sea-water as the copper sheathing, be almost certainly in metallic connection therewith, and have concentrated upon its comparatively small area the action of the very large surface of copper sheathing. The result must be very rapid corrosion of the iron skin, and possibly its perforation by holes. Such an accident, capable of stripping off wood planking 6 inches thick, firmly attached to an iron hull, must of course be exceptional in severity, and of very rare occurrence. No such case has yet occurred: but the Admiralty Regulations provide against the contingency, the commanding officer being ordered to have his ship examined and repaired with the least possible delay.

Allusion has already been made to the dangers attendant on galvanic action of the kind described, where some metal valve or pipe, connected with the iron skin and immersed in the same sea or bilge water, has produced local corrosion of a very serious and rapid character. The case of her Majesty's store-ship *Supply* illustrated this, and in the *Megara* also there was reason to believe that galvanic action had taken place.* To prevent such galvanic action on the iron skin, very stringent rules are, as was shown above, laid down for the guidance of officers charged with the construction or care of iron ships in the Royal Navy.

* See the report of the royal commission on the loss of the *Megara*.

To illustrate the greatly increased rate of corrosion of iron, incidental to galvanic action, a few examples may be taken from the results of the experiments recorded by Mr. Mallet. An iron plate immersed *alone* in clear sea-water was found to lose during a certain period a quantity which we will denote by unity: it was then immersed for an equal time in clear sea-water with an equal surface of the following metals electro-negative to it, and the corrosion increased as follows:—

Experiments.	Relative Corrosion.
Iron plate in contact with copper	4·96
” ” ” ” brass	3·43
” ” ” ” gun-metal	6·53
” ” ” ” tin	8·65
” ” ” ” lead	5·55

Other laboratory experiments, made on an extensive scale, have given different results for the relative intensities of the action of the various metals on the iron; but they fully confirm the fact that a greatly increased rate of corrosion results from galvanic action. The first two materials, copper and brass, are those of which the ship-builder has need to take most heed in arranging the sheathing or fittings of iron ships.

The increased cost of copper-sheathed iron ships is considerable, and in composite ships of the merchant fleet the use of the two thicknesses of planking is by no means common, doubtless because of the additional outlay required. With a single thickness of planking there is, of course, much greater risk of galvanic action, but in merchant ships Muntz-metal sheathing is commonly used, and its action on iron is supposed to be comparatively feeble. It has been asserted that no great difficulty would be encountered in making sheathing of such an alloy of copper and zinc as would be electro-neutral to iron, and have no galvanic action upon it when immersed in sea-water. We are unaware, however, that

any such sheathing has been tried, and nothing but experience could show whether or not it would be effective against fouling. Zinc sheathing has, however, been substituted for copper in many recent ships of the Royal Navy, and if it proves an efficient anti-fouling material, it will be much less costly than copper, and can under no circumstances produce anything but beneficial action on the iron hull.

Various plans have been tried for attaching zinc sheathing to iron hulls; that now commonly used in the Royal Navy is as follows:—A single thickness of planks (3-inch to 4-inch) is bolted outside the skin plating; to this the zinc sheets are nailed: the strakes of planking are not caulked, but the water which finds its way under the sheathing can pass freely through the seams to the iron skin. Iron stems and stern-posts are employed; and by various means a certain amount of metallic connection is made between the zinc and the iron hull, such connection, as explained previously, being desirable in order to keep the surface of the zinc freer from incrustation. Hitherto the practical difficulty has been to adjust the relative amounts of the surfaces of iron and zinc, contributing to galvanic action on the latter, in such a manner as to prevent too rapid or too local wearing of the zinc, without interfering with its anti-fouling properties. In fact, the present condition of this question bears a considerable resemblance to that previously existing, when iron protectors were under trial with copper sheathing. On wood ships, zinc lasts for a considerable time, but is not very successful in preventing fouling: there it has but little metallic contact to produce galvanic action. On some merchant ships where the zinc has been laid almost directly upon the iron skin, with felt or some similar material interposed, its rate of wear has been so quickened that a single voyage has sufficed to destroy it. Between these two conditions must lie the practically useful method of attachment, and upon this experience with actual ships can alone decide. Before many years the question will probably be in a much more settled condition; and although

there is little hope that zinc can ever be made to equal copper in its anti-fouling qualities and smoothness of surface, yet, if it be made fairly successful in this respect, it will greatly reduce the cost of construction, and the risks of accident or collision. Already it seems certain that a very great improvement upon the condition of unsheathed iron ships can be secured by the use of zinc sheathing.

At present, therefore, the question of preventing foulness of bottom in iron ships stands as follows:—By far the greater number of ships have their bottoms coated with some anti-fouling composition, and are docked for cleaning and recoating once or twice a year; when that is practicable, no serious loss of speed ensues. The annual cost for coating large ships may be taken as from £100 to £400 a year; and this is not a large outlay. A few iron ships, designed for distant voyages, and in which the power of keeping the sea, without serious loss of speed, during long periods is of great importance, have copper or zinc sheathing. Copper can be made to answer well as regards anti-fouling, but it involves a large additional outlay, and is open to the charge of possible damage to the iron hull in case of accident. Zinc has not been long enough in use to be regarded as having passed out of the region of experiment; but it promises to be fairly successful.

Many persons who admit the superiority of iron to wood hulls in vessels of the mercantile marine question the desirability of using iron hulls for war ships, unless they are ironclads. Unarmoured fighting ships, it is still urged, should be wood-built. A few remarks on this matter will not, therefore, be out of place.

Nearly forty years ago two iron steamers, the *Nemesis* and *Phlegethon*, were built for the East India Company, and successfully employed in the Chinese war of 1842. A few years later several iron frigates were ordered to be built for the Royal Navy; but these were ultimately converted into troopships, the *Simoom* and *Megæra* amongst the number.

This change was made after a series of experiments had been conducted with targets representing the sides of the *Simoom* and other vessels. These vessels had strong transverse frames spaced only 1 foot apart; and it was found that a very serious amount of splintering took place from the side of the ship first struck, while the opposite side was considerably damaged. On the whole, it was considered that the damage done by solid and hollow spherical shot to these iron ships was likely to prove of a more destructive character to the crews than the corresponding damage in a wood ship. But it was remarked that iron plating above $\frac{1}{2}$ inch in thickness sufficed to break up the shell and hollow shot from the heaviest guns then mounted in ships. This feature was undoubtedly a very great advantage of the iron sides, as compared with wood; and the destruction of the Turkish fleet at Sinope, as well as the experience with our own ships during the Crimean War, proved how great was the danger of wood hulls exposed to the fire of shell guns. On the whole, however, the decision arrived at from the trials in the *Simoom* target still holds good; and from that time to this no fighting ship of the Royal Navy has been built with uncovered iron sides, and closely spaced frames, in wake of the gun decks. Iron hulls were confined to armoured ships until the construction of the swift cruiser class, of which the *Inconstant* was the earliest example. In order to secure the requisite structural strength, an iron hull was then considered necessary; but the transverse frames were widely spaced, and the shattering effect of projectiles was still further reduced by covering the thin iron plating with wood planking. The *Simoom* target experiments had shown that wood so applied reduced splintering and damage: subsequent experiments at Shoeburyness, with targets representing respectively the sides of a wood frigate and those of a swift cruiser, have confirmed the soundness of this view, even when the vessels are exposed to the fire of heavier guns than those in use twenty-five years ago.

Before and abaft the central batteries or citadels of iron-

clad ships, there are frequently considerable portions of the topsides formed by thin uncovered iron plating; but in action these unprotected spaces would not be occupied by men, and splintering would not be productive of serious consequences. The coast-defence gunboats of the *Comet* class also have their thin iron plating exposed, but in them the single heavy gun is carried on the upper deck "in the open," and there is little to be feared from splinters: the chances of these little vessels being hit are also small. In fact, the only cases where guns are fought under cover of a deck, and behind thin plating unprotected by wood planking, are in the recently designed belted ships of the *Nelson* class in the Royal Navy; but in them very special arrangements are made to prevent splintering. The plating is of steel, about twice the thickness of an ordinary iron side: there are no numerous vertical frames behind it to be shattered; and any damage that may be done is restricted to a limited space by means of "traverse bulkheads" which are splinter-proof. On the whole, therefore, it may be safely asserted that the unarmoured or partially protected iron fighting-ships of the Royal Navy are not open to the objections which were fairly urged against the *Simoom* and her consorts thirty years ago, and which apply with considerable force to iron-built merchant ships of the present day.

In concluding this chapter, brief reference must be made to the substitution of steel for iron in shipbuilding.

The chief reason for such a substitution is the greater strength of steel. The varieties which have been used in shipbuilding have had tensile strengths from 26 to 50 tons per square inch; the corresponding strength for good iron varying from 17 to 22 tons. Hence with steel it is possible to use thinner plates and bars than with iron, in order to secure a certain strength: such thinner plates, &c., being, of course, much lighter, since steel is only about

2 per cent. heavier than iron. Numerous steel ships have been built with reductions of *one-fourth* or *one-third* from the scantlings which would have been considered necessary had iron been used: in some cases the reductions in scantlings have even reached *one-half*. The savings in weights of hull effected by using steel are very considerable, ranging, it is said, from 30 to 50 per cent. of the weight which the hull would have if built of iron and made equally strong. What is thus saved on hull is available for carrying power.

Notwithstanding the greater lightness of steel ships, it is a fact that comparatively few have been built as yet, the majority of those constructed being designed for special services where extremely shallow draught or exceptional lightness of hull was requisite. Vessels for river service, like that illustrated by Figs. 105 and 106, pages 339, 340, are frequently built of steel; and steel was also largely employed in the blockade-runners built during the Civil War in America; but taking the twenty years from 1850 to 1870, it appears that over 3,600,000 tons of iron shipping were built, while only 27,000 tons of steel ships were constructed. And this is still nearly as true as it was in 1870; the steel ships are comparatively few. In the Royal Navy, although steel has been for many years past extensively used for internal frames, stringers, and strengthenings, no ship was constructed wholly of steel until 1875; and at the present time only two such ships, the *Iris* and *Mercury*, armed despatch vessels, are being built, and the steel used in their construction is of a special character, only recently produced in this country.

Hitherto two main objections have existed to the use of steel: its greater cost, and the want of uniformity in its character, and in the qualities essential to successful resistance to the wear and tear of service. Its cost as compared with iron varies with the relative and absolute qualities of the materials used. Iron "ship-plates," for instance, of different qualities vary greatly in price; and so would steel plates.

But a good average is probably that which takes steel as about twice as costly as the iron in common use.

The more serious disadvantage of most of the varieties of steel is the want of uniformity in strength, ductility, and malleability. Steel plates made under similar conditions, and presumably of the same quality, have displayed, when tested, singular differences in their qualities; and the shipbuilder has consequently been without any assurance of safety, such as he may obtain with iron. In the Royal Navy the best quality of iron ship-plates used is required to have a tensile strength of from 18 to 22 tons per square inch; and this condition the manufacturer can fulfil almost certainly in association with defined conditions of malleability. But with steel, until recently, it was necessary to allow a wider margin; the tensile strength desired being about 33 tons per square inch, and an upper limit of 40 tons being fixed.* Moreover, it was found that the manipulation of steel during the various processes of building—punching holes, bending, riveting, &c.—required much greater care than did the corresponding operations with iron. And although of greater tensile strength than iron, and probably also of greater compressive strength, steel appeared, on the whole, less suited to withstand shocks or rough usage; its greater hardness and less malleability making it liable to fracture under conditions when good iron would simply bulge. Hence it resulted that in the ships of the Royal Navy steel was used only for internal strengthening, the outer bottom plating being of iron.

For many years the subject remained in much the same condition, notwithstanding frequent discussions and many attempts to produce steel of the quality and price suitable for shipbuilding. But during the last two years great

* Full details of the use of steel in the Royal Navy prior to 1875, and tests illustrating the want of uniformity in quality, will be found in Mr. Reed's *Shipbuilding in Iron and Steel*.

progress has been made both in France and England, and a so called "mild steel" has been produced free from the objectionable features mentioned above. The manufacture of this material in England is mainly due to the efforts of Mr. Barnaby, Director of Naval Construction, who had previously conducted most of the experiments on steel made in the Royal Dockyards, and done much to develop the use of the material.* "Mild steel" or "homogeneous iron" has a tensile strength of from 26 to 30 tons per square inch, being about 25 per cent. stronger than the best iron ship-plates: it is very ductile and malleable, and will not take a "temper" even when heated to a cherry-red and plunged into nearly cold water. It will withstand all the operations of the shipyard quite as well as, if not better than, wrought iron; and its cost is not great as compared with the high-class iron used in the ships of the Royal Navy. In no respect is it inferior to iron, and in very many it is much superior. For equal strengths, probably a reduction of *one-third* or *one-fourth* in scantlings and weight would be possible with this mild steel as compared with iron; but the *Iris* and *Mercury* have structural arrangements of so special a character that even, when completed, it will not be possible to compare fairly the ratio borne by their weight of hull to their displacement with that of iron ships of ordinary type. Speaking generally, it seems a fair assumption that, should this mild steel come into general use, it will be possible to build ships say 20 to 25 per cent. lighter than iron ships of equal strength; and although the outlay on the original construction may continue greater for some time, until the process of manufacture has become better known, this addition to the carrying-power will be a permanent advantage, and may more than recoup the additional outlay on construction during the period of service. Take, for example, a

* See Mr. Barnaby's paper on this subject in the *Transactions* of the Institution of Naval Architects for 1875; and its sequel in Mr. Riley's paper of the following year.

merchant steamer of about 5000 tons displacement, and the case would stand something as under:—

Distribution of Weights.	Iron Ship.	Steel Ship.
	Tons.	Tons.
Machinery, coals, stores, and equipment . . .	890	890
Hull	1600	1280
	2490	2170
Carrying power for cargo	2510	2830
Displacement	5000	5000

No less a quantity than 320 tons would be transferred from the hull to the cargo-carrying power; and this increase would tell greatly in favour of the steel ship during a service of twenty or thirty years.

It is only necessary to add that steel loses nothing as compared with iron in the variety of the forms in which it is produced, the efficiency of its connections, and its adaptability to the combinations required in the structure of a ship. Reduced thicknesses of plates and bars of course render necessary greater precautions against local failure, and particularly against buckling in the plating on decks, sides, or bottoms. Hence, if steel comes into general use, some longitudinal system of framing is likely to secure general adoption. Reduced thicknesses also necessitate greater care to prevent corrosion; and it is to be noted—although experience on this point is not sufficiently extensive to enable a definite opinion to be formed—that steel appears to corrode in sea-water rather more rapidly than iron. As to fouling, steel ships appear but little, if anything, better off than iron ships; in this particular further experience is requisite before a sound judgment can be formed.

Mild steel of the character described may ultimately be displaced by some stronger material having equally good qualities as regards ductility and workability. If the manufacturers can succeed in producing such steel at moderate cost, the ship-builder will be happy to avail himself of the opportunity to advance still further the combination of strength with lightness.

CHAPTER XI.

THE RESISTANCE OF SHIPS.

No branch of the theory of naval architecture has a richer literature than that which forms the subject of this chapter. It would be a formidable task merely to enumerate the names of eminent mathematicians and experimentalists who have endeavoured to discover the laws of the resistance which water offers to the progress of ships; and still more formidable would be any attempt to describe the very various theories that have been devised. Again and again has the discovery been announced of the "form of least resistance," but none of these has largely influenced the practical work of designing ships, nor can any be regarded as resting on a thoroughly scientific basis. In fact, a century and a half of almost continuous inquiry has firmly established the conviction that the problem is one which pure theory can never be expected to solve.

Although earlier theories of resistance are now discarded, and the present state of knowledge on the subject is confessedly imperfect, great advances have been made within the last half-century, and most valuable experimental data have been collected. The modern or "stream-line" theory of resistance may now be regarded as firmly established. Many eminent English mathematicians have been concerned in the introduction and development of this theory, as well as in the conduct of the experiments by which it has been put to the test. Of these, however, two only need be named. The late Professor Rankine did much

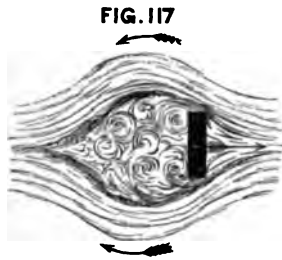
to practically apply the theory to calculations for the resistances and speeds of ships; and the broad generalisations which we owe to him have served ever since as guides to later investigators.* Mr. W. Froude is the second worker in this field of inquiry, whose labours deserve especial mention. The experiments which for some years past he has been conducting for the Admiralty are beyond all comparison with any that have gone before them; the greatest value attaches to the small portions of his results which have yet been published; and when the inquiry is completed, and the results are fully discussed, naval architects will be in possession of a mass of facts which cannot but prove highly advantageous to the designs of future ships. These experiments of Mr. Froude have been carried on upon the basis of the stream-line theory of resistance, and have fully confirmed its soundness. In addition, however, to this service, Mr. Froude has done more than any one else to elucidate and popularise the theory. His clear and masterly sketches of its main features are well worthy of careful study;† and they have the advantage of being almost entirely free from mathematics, so that the general reader can readily follow the reasoning and the experiments by which it is supported. In attempting, as we now propose to do, a brief outline of this modern theory, we gladly acknowledge our indebtedness to both Professor Rankine and Mr. Froude.

A few prefatory remarks are necessary in explanation of terms that will be frequently employed. Water is not, what is termed, a *perfect* fluid; its particles do not move past one another with absolute freedom, but exercise a certain amount of rubbing or friction upon one another, and upon any solid body past which they move. Suppose a thin board with a plane surface to be immersed in water and moved end-on, or edgewise, it will experience what is termed

* See div. i. chap. v. of *Ship-building, Theoretical and Practical*, edited by Professor Rankine.

† See *British Association Reports* for 1875.

frictional resistance from the water with which its surface comes into contact. The amount of this frictional resistance will depend upon the area and the length of the plane, as well as the degree of roughness of its surface and the speed of its motion. If this plane is moved in a direction at right angles to its surface, it encounters quite a different kind of resistance, termed *direct* or sometimes *head* resistance; this depends upon the area of the plane and the speed of its motion. Should the plane be moved obliquely, instead of at right angles to its surface, the resistance may be regarded as a compound of direct and frictional resistance. Supposing either direct or oblique motion to take place, the plane would leave an eddying "wake" behind it, as indicated somewhat roughly in Fig. 117, and the motion thus created



amongst the particles constitutes a very important element in their resistance to the passage of the plane. If the plane is not wholly immersed, or if its upper edge is near the surface, and it is moved directly or obliquely, it will heap up water in front as it advances, and create waves which will

move away into the surrounding water as they are formed, and will be succeeded by others. Such wave-making requires the expenditure of power, and constitutes a virtual increase to the resistance. If the plane were immersed very deeply, it would create little or no surface disturbance, and, therefore, require less force to propel it at a certain speed than would a plane of equal immersed area moving at the surface with a portion situated above that surface. This statement is directly opposed to the opinion frequently entertained; which confuses the greater *hydrostatical* pressure on the plane, due to its deeper immersion, with the dynamical conditions incidental to motion. Were the deeply immersed plane at rest at any depth, the pressures on its front and back surfaces would clearly balance one

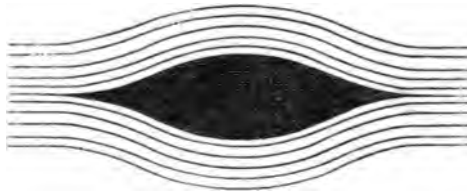
another. When it is moved ahead at a uniform speed, it has at each instant to impart a certain amount of motion to the water disturbed by its passage; but the momentum thus produced is not influenced by the hydrostatical pressures on the plane, corresponding to the depth of its immersion. Water is practically incompressible; apart from surface disturbance, the quantity of water, and therefore the weight, set in motion by the plane, will be nearly constant for all depths, at any assigned speed. In other words, if there were no surface disturbance, the resistance at any speed would be independent of the depth.

The earlier theories of resistance dealt almost exclusively with direct or oblique resistance, said little respecting frictional resistance, and nothing as to the other kinds. Commonly, the immersed surface of the ship was assumed to be subdivided into a great number of pieces, each of very small area, and approximately plane. The angle of obliquity of each of these elementary planes with the line of advance of the ship—her keel-line—was ascertained; and its resistance was calculated exactly as if it were a detached plane moving alone at the assumed speed. For quantitative purposes, experiments were to be made with small planes of known area moved at known speeds, and set at different angles of obliquity; the resistances being observed. It was generally accepted that the resistance varied with the area of the plane, the square of the speed, and the square of the sine of the angle of obliquity. But obviously there was a radical error in applying unit-forces of resistance, obtained from the movements of detached planes, to the case of a ship where all the hypothetical elementary planes were associated in the formation of a fair curved surface, and none of them could have that eddying wake (like that in Fig. 117) which necessarily accompanied each experimental plane and formed so important an element of its resistance. This objection does not apply to the experiments made under the auspices of the French Academy of Sciences, during the last century, by Bossut, Condorcet, D'Alembert, Romme, and others; these

experiments having been directed to the discovery of the resistances experienced by *solid bodies* of various forms moved at different depths. Very few of the models tried, however, had any pretension to ship-shaped forms; and this is also true of the subsequent experiments, made in this country, by Beaufoy; whose results furnished some of the most valuable data accessible up to the time that Mr. Froude began his experiments.

Satisfactory experiments on the resistances of ships can alone be made with ship-shaped models. This is the principle upon which Mr. Froude has proceeded in his experiments, and although many doubts were expressed respecting the correctness of the results deduced from models when applied to full-sized ships, there are now good reasons for trusting that method, some of which reasons will be stated further on.

FIG. 118.



The modern theory of resistance does not make any hypothetical subdivision of the immersed surface of a ship, but regards it as a whole. When such a surface, with its fair and comparatively gentle curves (like those in Fig. 118), is submerged and drawn through water, the particles are diverted laterally, and can glide over or past the ship without sudden or abrupt changes of motion, corresponding to those which occur when particles escape over the edge of the plane in Fig. 117. The paths of the particles are indicated roughly in Fig. 118 by the curved lines, the ship-shaped body being shown in black. After passing the broadest part of the vessel, the particles close in over the after part, and,

gliding over the continuous surface, form only a small wake astern.

In the modern theory, the total resistance is considered to be made up of three principal parts: (1) frictional resistance due to the gliding of particles over the rough bottom of the ship; (2) "eddy-making" resistance, due to a wake at the stern; (3) surface disturbance, or wave-making resistance. The second of these divisions only acquires importance in exceptional cases; it is known to be very small in well-formed ships. It will, therefore, be necessary to bestow most attention upon frictional and wave-making resistance, to examine the conditions governing each, and to contrast their relative importance. It will be assumed throughout that the ship is either dragged or driven ahead by some external force which does not affect the flow of the water relatively to her sides. This is the condition always assumed when the *resistance* of a ship is being treated. It is advantageous to separate propulsion from resistance, since the latter depends in all ships upon the form, proportions, and condition of the bottom; whereas there are many means of propelling ships. It will be shown hereafter that the action of a propeller, especially of the screw propeller, produces a virtual increase of the resistance, and that of serious amount; but, for the present, let it be supposed that the ship advances either by running before the wind or by being towed a considerable distance clear of another ship.

Suppose the ship to be moving ahead at uniform speed through an ocean unlimited in extent, and motionless except for the disturbance produced by the passage of the ship. Under the conditions assumed, there will obviously be no change in the *relative* motions of the ship and the water if she is supposed to remain fixed, while the ocean flows past her at a speed equal to her own, but in the opposite direction to that in which the ship really moves. Making this alternative supposition has the advantage of enabling one to trace more simply the character of the disturbances produced by

introducing the solid hull of the ship at a certain speed into water which was previously undisturbed. First, let the water be assumed to be frictionless, and the bottom of the ship to be perfectly smooth. These are only hypothetical conditions, but it is possible at a later stage of the inquiry to introduce the corrections necessary to represent the actual conditions of practice. Take any set of particles situated a long distance before the ship, and moving in a line parallel to her keel. If the ship were not immersed in the ocean current, these particles would continue to move on in the same straight line, which would be horizontal. When the ship is immersed, her influence upon the motion of the particles may extend to a very long distance ahead, but there will be some limit beyond which the influence practically does not extend; and outside this, the particles whose motion is being traced will be moving at a steady speed in a horizontal line parallel to the keel. As they approach the ship, however, their path must be diverted in order that they may pass her; and this diversion will be accompanied by a change in their speed. Supposing for the sake of simplicity that the particles maintain the horizontality of their motion, and are only diverted laterally: then, as they approach the bow of the ship, they will move out sideways from the keel-line, and lose in their speed of advance. Many considerations must govern the extent of this lateral diversion and loss of speed; such as the form of the bow, the extreme breadth of the ship, and the athwartship distance from the line of the keel of the original line of flow of the particles. After the midship part of the ship has been passed, and her breadth begins to decrease, the path of the particles will converge towards the keel-line; and their speed, which had reached its maximum amidships, will again receive a check. Finally, after flowing past the ship, and attaining such a distance astern as places them beyond the disturbing influence of the ship, the particles will regain their original direction and speed of flow, provided that there is *no surface disturbance*. This last-mentioned condition could only be

fulfilled in the case of a vessel wholly immersed, at a great depth, below the surface of an ocean limitless in depth; in the case of the ships which are only partly immersed, the retardations and accelerations described must cause the formation of bow and stern waves, and these we shall consider further on.

Although we have assumed, for the sake of simplicity, in the foregoing remarks that the particles maintain their horizontality of flow, it should be understood that the assumption is not supposed to represent the actual motion of the water in passing a ship. Diversion from the original line of flow is almost certain to have a vertical as well as a lateral component; but as to the paths actually traversed by particles, we have little exact knowledge. Mr. Scott Russell is of opinion that at the foremost part of a ship the particles move in layers which are almost horizontal; while at the stern the particles have a considerable vertical component in their motion, besides converging laterally. Professor Rankine asserts that "the actual paths of the particles of water in gliding over the bottom of a vessel are neither horizontal water-lines nor vertical buttock-lines, but are intermediate in position between those lines, and approximate in well-shaped vessels to the lines of shortest distance, such as are followed by an originally straight strake of plank, when bent to fit the shape of the vessel." But, whatever paths may be followed, if at a considerable distance astern of a ship, wholly submerged in a frictionless fluid, the particles have regained their original direction and speed of flow, which they had at a considerable distance ahead of the ship, then their flow past the ship will impress no end-wise motion upon her. To this point we shall recur.

Professor Rankine has laid down geometrical rules for constructing the paths, or "stream-lines," along which the particles of a frictionless fluid would flow in passing a body very deeply submerged, supposing the particles to move in plane layers of uniform thickness. Fig. 119 has been con-

structed by Mr. Froude in accordance with these rules.* The form of the immersed body with its comparatively blunt bow and stern is indicated in black; the curved lines indicate the paths of particles. Between any two of these stream-lines, the same particles would be found throughout the motion, and these would form a "stream" of which the stream-lines mark the boundaries. It will be noted that, as the streams approach the bow, they broaden, their speed being checked, and the particles diverted laterally; the amount of this diversion decreases as the athwartship distance of the stream from the keel-line increases, and at some distance athwartship the departure of the stream-lines from parallelism with the keel,

FIG. 119



even when passing the ship, would be very slight indeed. As the streams move aft from the bow, they become narrowed, having their minimum breadth amidships, where the speed of flow is a maximum. Thence, on to the stern, the streams converge, broaden, lose in speed, and finally at some distance astern resume their initial direction and speed. Since there is no friction, there can be no eddying wake.

So much for a vessel wholly submerged; a ship only partly immersed would be differently situated, because even in a frictionless fluid she would produce surface disturbance. At the bow, where the streams broaden and move more slowly, a wave crest will be formed, of the character shown in

* See the address to the Mechanical Section of the British Association in 1875. Professor Rankine's me-

thod is described at pages 106, 107 of *Shipbuilding, Theoretical and Practical*.

Fig. 120 ; amidships, where the conditions are reversed, some depression below the normal water-line will probably occur ; and at the stern, where the conditions resemble those forward, another wave crest will be formed. Between the bow and stern waves a train of waves may also exist, under certain circumstances. The existence of such waves, when actual ships are driven through the water, is a well-known fact ; every one readily sees why, at the bow, water should be heaped up, and a wave formed, but the existence of the stern wave is more difficult to understand. As remarked above, there is but one reason for both phenomena. A check to the motion of the particles is accompanied by an increase of pressure ; the pressure of the atmosphere above

FIG.120



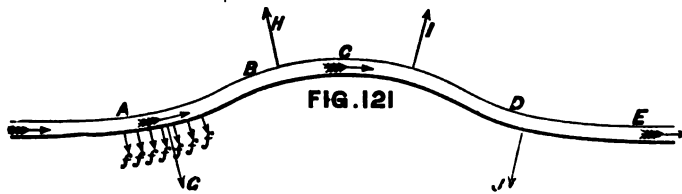
the water is practically constant, and hence the increase of pressure in the water must produce an elevation above the normal level, that is to say, a wave crest. Conversely, amidships, accelerated motion is accompanied by a diminution of pressure, and there is a fall of the water surface below the still-water level, unless the intermediate train of waves should somewhat modify the conditions of the streamline motion.

These waves require the expenditure of force for their creation, and, when formed, they may travel away into the surrounding fluid, new waves in the series being created. In the case, therefore, of a ship moving at the surface of frictionless water, the only resistance to be overcome will be that due to surface disturbance. For the wholly submerged body which creates no waves there will be no resistance, when once the motion has been made uniform ; the stream lines once established in a frictionless fluid will maintain their motion without further expenditure of power.

This remarkable result follows directly from a general

principle, which is thus stated by Professor Rankine:—
 “When a stream of water has its motion modified in passing
 “a solid body, and returns exactly to its original velocity
 “and direction of motion before ceasing to act on the solid
 “body, it exerts on the whole no resultant force on the solid
 “body because there is no permanent change of its momen-
 “tum.” In every stream surrounding the submerged body
 in Fig. 119, this has been shown to hold; each stream regains
 its initial direction and velocity astern of the body. The
 partially immersed ship in the frictionless water differs
 from the submerged ship in producing surface disturbance.

Perhaps the general principle will be better understood if
 we borrow one of Mr. Froude’s many simple and beautiful
 illustrations. Taking a perfectly smooth bent pipe (Fig. 121),



he supposes it to be shaped symmetrically, and divides it
 into four equal and similar lengths, AB, BC, CD, DE. The
 ends of the pipe at A and E are in the same straight line; a
 stream of frictionless fluid flows through it, and has uniform
 speed throughout. From A to B may be supposed to
 correspond to the forward part of the entrance of a ship,
 where the particles have to be diverted laterally, and react
 upon the inner surface of the pipe, as indicated by the small
 arrows f, f, f , the resultant of these normal forces being G.
 At the other end of the pipe, from D to E may be taken to
 represent the “run” of a ship, where the stream-lines are
 converging and tending to resume their original directions;
 on DE there will be a resultant force J equal to G. Similarly,
 the resultant forces on the other two parts BC and CD are
 equal. The final result is that the four forces exactly
 neutralise one another, and there is no tendency to force the

pipe on in the direction of the straight line joining A to E, although at first sight it would appear otherwise. The same thing will be true if, instead of being uniform in section, the pipe is of varying size; and if instead of being symmetrical in form, it is not so: provided only that at the end E the fluid resumes the velocity it had at A and flows out in the same direction. The forces required to produce any intervening changes in velocity and direction must have mutually balanced or neutralised one another, as in the preceding example, before the stream could have returned to its original velocity and direction of motion.

Applying these principles to the stream-lines surrounding a ship, it will be possible to remove one or two difficulties which have given rise to erroneous conceptions. It has been supposed, for example, that a ship in motion had to exert considerable force in order to draw-in the water behind her as she advanced. As a matter of fact, however, the after part of a ship has not to exercise "suction" at the expense of an increased resistance, but sustains a considerable forward pressure from the fluid in the streams closing in around the stern. Any cause which prevents this natural motion of the streams, and reduces their forward pressure on the stern—such as the action of a screw-propeller—causes a considerable increase in the resistance, because the backward pressures on the bow are not then so nearly balanced by the forward pressures on the stern. Again, it will be evident that—apart from its influence on surface disturbance—the extent of the lateral diversion of the streams, in order that they may pass the midship part of the ship, does not affect the resistance so much as might be supposed; since the work done on the foremost part of the ship in producing these divergences is, so to speak, given back again on the after part where the streams converge. Very considerable importance attaches, however, to the lengths at the bow and stern over which the retardations of the particles extend; since these lengths exercise considerable influence upon the lengths of the bow and stern waves created by the motion of the ship.

And, further, the ratios of these lengths of entrance and run to the extreme breadth of the ship must be important, as well as the curvilinear forms of the bow and stern, since the extent to which the particles are retarded in gliding past the ship must be largely influenced by these features; and, as we have seen, the heights of the waves will depend upon the maximum values of the retardations. In other words, with the same lengths of entrance and run, differences in the "fineness" of form at the bow and stern may cause great differences in the heights of the waves created, as well as in the energy required to create and maintain such waves.

Such are the principal features of the stream-line theory of resistance for frictionless fluids and smooth-bottomed ships. The sketch has been necessarily brief and imperfect, but it will serve as an introduction to the more important practical case of the motions of actual ships through water. Between the hypothetical and actual cases there are certain important differences. First, and by far the most important, is the frictional resistance of the particles of water which glide over the bottom; secondly, friction of the particles on one another in association with certain forms, especially at the sterns of ships, may produce considerable eddy-making resistance, although this is not a common case; thirdly, friction may so modify the stream-line motions as to alter the forms of the waves created by the motion of the ship, and somewhat increase the resistance.

First, as to *frictional* resistance. Its magnitude depends upon the area of the immersed surface of the ship, upon the degree of roughness of that surface, or its "coefficient of friction," upon the length of the surface, and upon the velocity with which the particles glide over the surface. From what has been said above, it will appear that this velocity of gliding varies at different parts of the bottom of a ship, being slower at the bow and stern than it is amidships. But, after making many experiments, Mr. Froude has come to a conclusion which greatly simplifies the calculation of this im-

portant factor in the total resistance. He affirms that no sensible error is involved in calculating the frictional resistance "upon the hypothesis that the immersed skin is equivalent to that of a rectangular surface of equal area, and of length (in the line of motion) equal to that of the model, moving at the same speed." Hence, it is only necessary to experiment with such a plane surface as will enable the proper coefficient of friction to be found, then to measure the immersed surface of the ship, and to apply the coefficient, neglecting the slight variations in speed of the particles at different parts of the surface.

Mr. Froude has made a series of such experiments for the Admiralty, and the results, which have been published,* will well repay careful study. Space will only permit us to give one or two facts deduced from these experiments. First, it seems to be established that frictional resistance varies very nearly as the *square* of the velocity, this having been the law formerly assumed to hold, provided the area, length, and condition of the surface remain unchanged.† Second, the *length* of the surface appears to have an important effect upon the mean resistance in pounds per square foot of surface. For instance, a plane 8 feet long coated with varnish, and moving at a speed of 600 feet per minute, was found to have a mean resistance of 0.325 lb. per square foot of surface; whereas a similar plane 50 feet long, moving at the same speed, had a mean resistance 20 per cent. less (viz. 0.25 lb. per square foot). For greater lengths than 50 feet, it appears that the mean resistance per square foot of area remains nearly the same as for the plane 50 feet long; being so little less that the decrease may be neglected in dealing with ships 300 or 400 feet long. In comparing the resistances of a small model and a full-sized ship, however, the allowance for difference of length is very important,

* In the Reports of the British Association and elsewhere.

ance varied as the 1.8 or 1.9 power of the velocity.

† For most surfaces the resist-

especially at high speeds; and this correction always appears in the records of the experiments made by Mr. Froude. The explanation of this experimental fact is best given in the words of its discoverer. "The portion of surface that goes first in the line of motion, in experiencing resistance from the water, must in turn communicate motion to the water in the direction in which it is itself travelling; consequently the portion of the surface which succeeds the first will be rubbing, not against stationary water, but against water partially moving in its own direction; and cannot, therefore, experience as much resistance from it."

A third important deduction is the great increase in frictional resistance which results from a very slight difference in the apparent roughness of the surface. For instance, Mr. Froude discovered that the frictional resistance of a surface of unbleached calico—not a very rough surface—was about double that of a varnished surface. This varnished surface, it is interesting to note, gave results just equal to a surface coated with smooth paint, tallow, or compositions such as are commonly used on the bottoms of iron ships. The frictional resistance of such a surface moving at a speed of 600 feet per second would be about $\frac{1}{4}$ lb. per square foot; which would give a frictional resistance of about 1 lb. per square foot of immersed surface for the clean bottoms of iron ships when moving at a speed of about 12·8 knots. This unit is worth noting. It is also easy to see, since a slight increase in roughness doubles the frictional resistance at any speed, why foulness of the bottom, especially in iron ships, often causes a considerable loss of speed.

Frictional resistance is the most important element of the total resistances of ships; and in well-formed ships moving at moderate speeds it constitutes nearly the whole of the resistance. This fact has been established experimentally, but was predicted on theoretical grounds. The experiments made by Mr. Froude on her Majesty's ship *Greyhound*, and those made by him on numerous models, show that for speeds of from 6 to 8 knots—or about the half-speed of

ordinary ships—the frictional resistance with clean bottoms is 80 or 90 per cent. of the total resistance, and at the full speeds, even of the swiftest ships, the frictional resistance equals 60 or 70 per cent. of the total resistance.* When the bottoms become foul, and the coefficients of friction are doubled or trebled in consequence, frictional resistance, of course, assumes a still more important place; the practical effect of which is, as already remarked, a great loss of speed, or a considerably greater expenditure of power in reaching a certain speed.

It will have been remarked that the method of estimating the frictional resistance on the immersed surface of a ship by comparison with that of an immersed plane of equal area and length, as well as of the same degree of roughness, takes no account whatever of the *forms* and *proportions* of ships. Two ships of very different forms, but of equal area of bottom and equal length, will have the same frictional resistance for the same speed; but they are likely to have different total resistances. The influence of form and proportion is greatest at high speeds, and it is chiefly felt in the direction of surface disturbance or wave-making; eddy-making or wake formation also depends upon form, especially at the stern.

All investigators agree that in well-formed ships with easy curves at the entrance and run *eddy-making* resistance will be small. The frictional “drag” of the ship upon the particles of water which glide past it impresses upon them a forward velocity in all cases, and forms a wake; this will have but a small speed and momentum in well-formed ships, and will probably be proportioned to the frictional resistance. Mr. Froude estimates that *eight* per cent. of the frictional resistance is a fair allowance for eddy-making in a well-

* For details in support of these statements, see the papers contributed by Mr. Froude to vols. xv.

and xvii. of the *Transactions* of the Institution of Naval Architects.

formed ship, when (to revert to our old illustration) the stream-lines would converge easily towards the stern, and have regained very nearly their original velocities and directions before they leave the ship. With a full stern, and abrupt instead of gently curved terminations to the water-lines of a ship, the particles of water cease to act upon her at a period when they still retain a considerable forward velocity; and the momentum thus created, and not given back in forward pressure on the stern, is a virtual increase to the resistance. Behind the stern of such a vessel will lie a mass of so-called "dead-water," an eddying wake like that behind the plane in Fig. 117. Such a form of stern is objectionable, and is never adopted unless its use is unavoidable in order to fulfil other and more important conditions than those affecting the resistance. The floating batteries built during the Crimean War were constructed with very full sterns, and great displacement in proportion to their extreme dimensions; their performances under steam were very indifferent as compared with those of better-formed ships. But they were designed for very special services, to float heavy guns and armour, and economical propulsion was not made a feature in their designs.

Next as to *wave-making* resistance. The general character of the causes which create waves at the bows and sterns of ships moving in a frictionless fluid have already been sketched, but may be again briefly stated. At the bow and stern, the motion of the particles of water relative to the ship has its minimum, and there are wave crests; amidships the relative motion has its maximum speed, and there may be a wave hollow. In other words, considering the ship as in motion and the water as motionless except for the motion she impresses upon it, the particles of water at the bow and stern will have motion in the same direction as the ship; those amidships will have motion in the opposite direction. Besides these two principal wave crests at the bow and stern, there may be other minor waves created; the general

principle being that a crest will be formed wherever the particles attain a maximum speed in the direction of the advance of the ship ; and a hollow will be formed where the particles have a maximum speed in the opposite direction. The main bow wave may also be followed by a train of waves, successive waves in the series having diminished heights.

In a frictional fluid like water there will be some differences in the wave-making from that sketched for the frictionless fluid. There will be a bow wave as before ; but the frictional drag of the ship upon the particles of water will alter the wave form, and probably change the position of the crest. Amidships the frictional drag will necessarily diminish, and possibly destroy, the sternward motion of the particles ; so that there may be little or no depression of the water there below its normal level in consequence of the stream-line motion. At the stern, friction will similarly modify the wave of replacement, giving the particles a greater forward velocity than they would have in a frictionless fluid.

It will, of course, be remembered that throughout this discussion no propeller is supposed to be in action, which could modify the relative motions of the water and the ship. But it is worth notice that the action of propellers may create additional wave crests, or modify considerably those formed by the ship. Paddle-wheels, for example, placed nearly amidships, accelerate the sternward motion of particles, and produce an additional wave. Screw-propellers, on the contrary, being placed aft, give sternward motion to the particles, and tend to degrade the stern wave, as well as to cause considerably greater resistance by partially destroying the forward pressure of the water upon the stern ; but they also create a local upheaval of the water, and confuse the phenomena of the waves.

Confining attention for the present to the bow wave—sometimes termed the “wave of displacement”—let us endeavour to illustrate a matter of great practical importance

to which allusion has already been made: viz. the intimate connection which should exist between the intended full speed of a ship and the length of her "entrance."* The length of the bow wave from crest to hollow depends upon the length of the entrance; in other words, during each interval occupied by a ship in advancing through a distance equal to the length of her entrance, the sets of particles then contiguous thereto have to undergo the accelerations which lead to the production of the bow wave. This interval of time depends upon the ratio of the length of entrance to the speed of the ship. Furthermore, it is a well-known fact that deep-sea waves, once formed, will travel over immense distances without any great loss of speed, and that their speeds depend directly upon their lengths. The rules previously given for deep-sea waves may be considered to hold fairly well also for the waves which are created by ships moving in deep water; applying them, it is easy to ascertain the speed at which a wave will move naturally, when its length equals the length of entrance of a ship, or to discover what will be the length of a wave which has a speed equal to the intended maximum speed of the ship.† Supposing the maximum speed of the ship to be known, then the naval architect knows that, if the length of her entrance is made sufficiently great to form a bow wave having a natural speed at least as great as the speed of the ship, the wave-making resistance may be made as small as is possible concurrently with other essential conditions. On the other hand, with a less length of entrance, forming a bow wave of which the natural speed is less than the maximum speed of the ship, it may be taken for granted that the wave-making resist-

* By "entrance" is meant the part of the ship bounded by the stem and the foremost athwartship section which has the full dimensions of the midship section. The "run" is the corresponding length at the stern.

† For these rules, see page 167. The case of motion of ships in shallow water is so special that it cannot now be considered. For sea-going ships the conditions of the text are fulfilled.

ance will assume serious proportions relatively to the other factors of the resistance.

Very similar remarks apply to the relations which should be secured between the length of the "run" of a ship—upon which the length and natural speed of the stern wave depend—and the maximum speed at which the ship is to be driven. Unless the length of the run is sufficient, a serious increase in the wave-making resistance may be looked for as the full speed is approached.

With the same lengths of entrance and run, very different forms and proportions of length to breadth may have to be associated, in order to fulfil changed conditions. Two ships, for example, may have nearly the same area of immersed skin, but in the one the proportion of length to breadth may be much smaller than in the other; and although the lengths of entrance and run correspond in the two cases, the water-lines of the shorter ship may be bluffer than those of the longer ship. It would then be reasonable to suppose that the frictional and eddy-making resistances of the two ships would be practically equal for any assigned speed; but the wave-making resistances might differ considerably, the shorter, bluffer ship creating much greater disturbance. And this increase in wave-making resistance might have to be incurred in order that other conditions, even more important than those relating to diminution of resistance, might be fulfilled. Hence it appears that in ships having lengths of entrance and run amply sufficient to fulfil the condition stated above, differences in forms and proportions of the bows and sterns may produce corresponding differences in the heights of the bow and stern waves, as well as in the forces required to create and maintain such waves, these forces varying with the heights. At present, however, we are not concerned with this general question of the variation of resistance produced by changes in the form and proportions, but simply desire to explain the important practical rule that certain minimum lengths of entrance and run proportioned to the full speeds should be provided, and can be

provided, in nearly all ships, no matter what forms and proportions may have been determined upon in order to fulfil their special conditions of service. Unless these minimum lengths are secured, the wave-making resistance at the full speeds must assume undue importance.

The laws which govern the wave-making resistance are not yet fully understood; but the following explanation of the rapid increase in the magnitude of that resistance, which takes place when a certain limit of speed is exceeded, appears reasonable. If the lengths of entrance and run are sufficient for the intended full speed, the bow and stern waves, once formed, will have such a natural speed that they can *travel with the ship*, causing but little additional resistance by the expenditure of power required to maintain them. The case is parallel to that of the deep-sea waves maintaining their speeds while they travel long distances; with this difference, that the bow and stern waves have to be maintained at their full heights, at the expense of a virtual increase in the resistance of the ship. On the other hand, if the lengths of entrance and run are insufficient for the intended full speed, the natural speed of the bow and stern waves will be less than the full speed of the ship, and in order that the waves may accompany her, their speed will have to be accelerated. Hence it follows that, instead of travelling with the ship, these slower-moving waves diverge from her path, carrying off into still water the energy she has impressed upon them. The ship has therefore to be continually creating new waves as she advances, the power thus expended being a virtual increase in the resistance, often of a serious character. This cause of increased resistance begins to operate only when the speed of the ship exceeds the natural speed of the waves corresponding to the lengths of entrance and run; it may therefore be anticipated that in a vessel, defectively formed as to the length of entrance or length of run, the law of her resistance will undergo a sudden change when her speed passes beyond that of the natural speed of her bow and stern waves.

Numerous experiments have confirmed the general accuracy of this view of the subject; and one or two illustrations will be given hereafter.

Mr. Scott Russell first drew attention to the importance of wave-making resistance, and its relation to the length of entrance and run. His researches on this subject furnished the data upon which his well-known "wave-line theory" of constructing ships was based.* This theory has not greatly influenced the practice of naval architects, nor is it generally accepted as an accurate representation of the phenomena of resistance; but it has the great merit of having enforced the importance of, and given practical rules for, proportioning the lengths of the entrance and run to the intended speeds of ships; and these rules deserve mention. The lengths of entrance and run are measured as before described. The entrance is also termed the "fore body"; the run, the "after body"; and if amidships there is a certain length of constant cross-sectional form, it is termed the "middle body." The length of the entrance, it is considered, should be equal to the length of the "wave of translation," of which the natural speed equals the maximum speed for which the ship is designed. This wave of translation differs from a trochoidal wave in being wholly situated above the still-water level, travelling as a heap of water, and not having hollows depressed below the still-water level. But for deep water, and for the small heights which waves attain when travelling with ships, no error of practical importance is involved in estimating the period and speed of waves of translation by the rules previously given for trochoidal waves. In shallow water there would be a necessity for considering the waves of translation separately, and also for altering the rules given for the trochoidal deep-sea waves; but into these special circumstances it is not necessary to enter, since they

* For particulars of this theory, see Mr. Russell's work on *Naval Architecture*; also vol. i. and ii. of the *Transactions* of the Institution of Naval Architects.

are important only in vessels designed for river or shallow-water service, and scarcely affect sea-going ships.

Treating the wave of translation as a trochoidal wave in the relation of its length and velocity, the rules of Mr. Scott Russell may be stated in the following simple form:—Let V be the maximum speed of the ship (in knots per hour); L_1 be the length of entrance appropriate to the speed V , and L_2 the length of run (both lengths being expressed in feet): then

$$\begin{aligned} L_1 &= 0.562 \times V^2, \\ L_2 &= 0.375 \times V^2 = \frac{2}{3} L_1. \end{aligned}$$

For example, let $V = 15$ knots, then, to avoid undue wave-making, the theory prescribes:—

$$\begin{aligned} \text{Length of entrance} &= 0.562 \times 15^2 = 126 \text{ feet;} \\ \text{Length of run} &= 0.375 \times 15^2 = 84 \text{ feet.} \end{aligned}$$

With these dimensions might be associated any required length of middle body, the additional resistance for the assigned speed being chiefly due to friction on the enlarged immersed surface.*

Of these two rules, that relating to the length of run is thought to have the greatest practical importance, many successful vessels having had a less length of entrance than that prescribed by the formula; whereas vessels with shorter runs than the formula prescribes have done badly. As a matter of fact, however, sea-going vessels usually have greater lengths both of entrance and run, in proportion to their maximum speeds, than are required by these rules; and instead of having the run only two-thirds as long as the entrance, the lengths of entrance and run are commonly equal, or nearly so.

It will be observed from the preceding formula that

$$L_1 + L_2 = 0.937 V^2;$$

whence

$$V^2 = 1.067 (L_1 + L_2); \text{ and } V = 1.03 \sqrt{L_1 + L_2} \text{ (nearly).}$$

* See further on this subject the recent experiments of Mr. Froude, mentioned at page 450.

So far as can be seen at present, this last equation enables a fair approximation to be made to the speed (V) at which a small increase in speed causes an increase in resistance altogether disproportionate to that which would accompany an equal increase in speed when the vessel was moving more slowly. Putting the equation in this form allows for any variations which may be desirable in practice in the ratio of the length of entrance to that of run; although neither of these can become very short in proportion to the speed without producing increased resistance. Suppose, for instance, that the common practice is adhered to, and the lengths of entrance and run made equal to one another: it may be desired to know what are the lengths appropriate to a speed of 16 knots. Here

$$L_1 + L_2 = 0.937 \times (16)^2 = 240 \text{ feet (nearly).}$$

The *Inconstant*, which has a total length of 337 feet, and a speed of 16 knots on the measured mile, might therefore have about 90 feet of parallel middle body, without encountering this undue growth of wave-making resistance; but other considerations might make it preferable to avoid having any parallel middle body.

Professor Rankine suggested another mode of approaching the investigation of the speed at which wave-making resistance begins to grow at a very disproportionate rate. He proposed to express the natural speed of advance of the waves raised by a ship in terms of the "virtual depth of disturbance" which she causes, and considered that this virtual depth must bear some relation to the "mean depth of immersion" of the part of the ship which creates the wave. Taking the after body of a ship, for example, he would estimate its displacement (in cubic feet), and divide this by the area of the water section of that part (in square feet), the quotient expressing the mean depth of immersion. But he owned that experiment alone can decide what the relation may be between this mean depth and the natural speed of the waves created. From a few calcula-

tions which we have made it would appear that the virtual depth of disturbance must be very considerably greater than the mean depth of immersion if this principle is to be accepted. We are unaware of any experiments having been made to test the proposal; and it would seem more important, for ocean navigation, to have regard to the actual lengths of the entrance and run rather than to the virtual depth of disturbance.*

Mr. Froude has investigated this question experimentally, and published some interesting results, agreeing in the main with the general considerations upon which Mr. Scott Russell proceeded, but not coinciding absolutely with the very definite form in which the wave-line theory has been expressed. According to these experiments, the total length of a ship, as well as her lengths of entrance and run, affect the wave-making resistance, especially at speeds exceeding those for which the lengths of entrance and run are suitable. Mr. Froude has discovered that the position of the crest of the last wave in the train of waves that follow the bow wave, and lie along the side of the ship, exercises a very sensible effect on the resistance. If the length and speed of the ship are such that this wave has its *crest* at or near the middle of the length of run, it delivers a forward pressure on the after body, and this is equivalent to a diminution of resistance. A contrary effect is produced when a *wave hollow* occupies the position named.† Mere increase in the length of a ship may not, according to this view of the matter, be a cause of decreased wave-making resistance, when the increase is obtained by introducing a middle body. Mr. Froude has strongly advocated the policy of adopting a greater extreme breadth, in association with a longer and finer entrance and run, as a means of avoid-

* Professor Rankine made this suggestion in 1868; see his paper in the *Transactions* of the Institution of Naval Architects.

† See the paper read at the meetings of the Institution of Naval Architects in March 1877.

ing undue wave-making, rather than of having a less breadth, associated with less lengths of entrance and run and a middle body, with the same displacement. Other considerations, however, may render it necessary to use a middle body; and then the latest experiments of Mr. Froude become of the greatest practical importance. It may indeed be hoped that, from the continuance of these experiments, still more valuable information will be obtained respecting the general laws governing wave-making resistance.

All authorities now agree that for every ship there is a certain limit beyond which any increase of speed can only be secured at the expense of a very rapid growth in the resistance; and all agree that this sudden change occurs in the wave-making factor of the resistance. It may, of course, become necessary to incur this expense, and to drive a ship at a higher speed than the natural speed of the waves raised by her entrance and run. In fact, the quick steam-launches built recently, with lengths of 50 to 100 feet, can be, and are, driven at speeds of 16 to 20 knots; for which the sum of the lengths of entrance and run, according to the preceding formula, should equal from 240 to 400 feet. But in the following chapter it will be shown how abnormally great is the proportion of power to displacement in these remarkable little vessels, when compared with the most powerful and speedy sea-going ships.

From the experiments conducted by Mr. Froude, it may be interesting to quote one or two illustrations of this important fact, as well as to compare them with the results which would follow from the use of the wave-line formula. An interesting series of experiments was made with a model of the merchant steamer *Merkara* and models of alternative forms; we will select one comparison where two models having the same length and very nearly the same area of immersed skin were tried under similar conditions.*

* See the details given by Mr. Froude in vol. xvii. of the *Transactions* of the Institution of Naval Architects.

The dimensions of these two vessels (in feet) were as under:—

Models.	Length.				Extreme Breadth.	Mean Draught.
	Entrance.	Middle Body.	Run.	Total.		
<i>Merkara</i> . . .	144	72	144	360	37·2	16·25
Model B . . .	179·5	Nil	179·5	359	45·88	18

The *Merkara* had an area of immersed surface of 18,600 square feet; model B an area of 19,130 square feet; the displacement in each case was 3980 tons. So far as surface friction went, therefore, the *Merkara* had a small advantage; as to eddy-making, the two ships must have been practically equal, and the difference between the two would arise from differences in the wave-making resistance. On trial it was found that about 18 knots marked the limit of speed for the *Merkara*, where a slight increase in speed led to a disproportionately large increase in the wave-making resistance. At a speed of 19 knots the wave-making resistance of the model of the *Merkara* was found to be fully 60 per cent. of the whole resistance, whereas at the actual maximum speed of the ship—13 knots—wave-making resistance was only 17 per cent. of the whole. No limit of speed corresponding to 18 knots in the *Merkara* was found for model B up to speeds of 19 or 20 knots; and this want of any disproportionate increase in the wave-making made the resistance of B at a speed of 18 knots only 75 per cent. that of the *Merkara*, whereas at 13 knots the difference in the resistances was very trifling.

Applying the formulæ of the wave-line theory to these two vessels, we have—

$$\text{For } \textit{Merkara} \quad \sqrt{L_1 + L_2} = \sqrt{288} = 17 \text{ (nearly).}$$

$$\text{Limiting speed } V = 17 \times 1\cdot03 = 17\frac{1}{2} \text{ knots (nearly).}$$

$$\text{For model B } \sqrt{L_1 + L_2} = \sqrt{359} = 19 \text{ (nearly).}$$

$$\text{Limiting speed } V = 19 \times 1\cdot03 = 19\cdot57 \text{ knots (nearly).}$$

There is consequently a close agreement between theory and experiment as to the limit of speed beyond which the growth of resistance becomes disproportionately great.

As a second example the case of her Majesty's ship *Greyhound* may be taken, as she is in all respects a contrast to the *Merkara*. Her length (from stem to body-post) is 160 feet; the lengths of entrance and run each about 75 feet; breadth extreme $33\frac{1}{2}$ feet, and mean draught $13\frac{1}{4}$ feet. The load displacement on the trials was 1160 tons, area of immersed surface 7540 square feet, and maximum speed under steam 10 knots. In order to ascertain the resistance, the *Greyhound* was towed by the *Volage* at varying speeds, the maximum being about 13 knots, or 3 knots above the maximum attained with her own steam-power. According to the formulæ on page 448 to this speed of 10 knots should correspond a minimum length of entrance and run rather under 100 feet; and, therefore, no inordinate growth of wave-making should have occurred up to this speed. Nor did any such abrupt growth take place during the experiments. The bluff form of the ship made the wave-making resistance much greater, in proportion to the frictional, than in the *Merkara*; for example, at 12 knots the frictional resistance is only 35 per cent. of the total resistance in the *Greyhound*, whereas in the *Merkara* the corresponding percentage is 78. But this does not affect the question now under consideration, which has to do not so much with the proportion of the two parts of the resistance as with the abrupt growth which occurs in the wave-making factor when the lengths of entrance and run are insufficient.

It must be remarked that, so long as frictional resistance forms the larger part of the total resistance, the law which was formerly received as general holds fairly well, the resistance varying nearly as the square of the speed. In the *Merkara*, for example, the law holds very closely up to the speed of 13 knots, at which, as was remarked above, the frictional resistance formed about 80 per cent. of the total. In the *Greyhound*, the same law holds very fairly up to about

8 knots only, the frictional resistance at that speed being about 70 per cent. of the total; but beyond that speed the gradual growth in importance of the wave-making factor makes the total resistance vary with a higher power than the square of the speed. At 10 knots it varies nearly as the cube of the speed; and at 12 knots, nearly as the fourth power. Hence it appears that considerable lengths of entrance and run and fine forms are advantageous, not merely in adapting vessels for high speeds, but in keeping down the law of increase in terms of the velocity for more moderate speeds.

If economical performance under steam were the sole or principal condition to be fulfilled in the *Greyhound*, it would undoubtedly have been preferable to adopt greater proportions of length to breadth, and finer forms at the extremities; then, with the same lengths of entrance and run, associated perhaps with a certain length of middle body, there would probably be somewhat greater frictional resistance than in the actual ship, but a very considerable decrease in the wave-making resistance, and on the whole a less resistance would have to be overcome in obtaining the designed speed. Such latitude of choice in forms and proportions was not, however, possible in the design of the *Greyhound*. She was intended to be efficient under sail, as well as to have moderate speed under steam; hence, moderate proportions of length to breadth became necessary, in order to secure sufficient "stiffness," and handiness. Greater fulness of form at the extremities accompanying these moderate proportions involved an increase in the wave-making resistance; and here we have an illustration of the statement made previously, that, in designing ships, the naval architect frequently has to put into a subordinate place considerations of diminished resistance and economical performance. This is especially true of the designs of war-ships; in constructing merchant ships, the naval architect can exercise greater control over the proportions; and in merchant steamers, the sail-power being only auxiliary to the steam-power, there is not the

same necessity for moderate proportions and considerable stiffness as exists in vessels intended to perform well under sail alone.

The tendency in the merchant service has been, for many years past, towards an increase in the proportion of length to breadth in steamers; and in Chapter X. several examples of the change have been given. Continuance of this policy of construction, and the gradual advances made by the same owners on the lengths of ships, may be regarded as good evidence of its advantages from a commercial point of view. The common plan is that illustrated in the *Merkara*, a certain length of parallel middle body being introduced between lengths of entrance and run, sufficient to prevent any undue growth of the wave-making resistance within the intended limits of speed. Mr. Froude has made numerous experiments on vessels of the *Merkara* and alternative types; and his results appear to show two most important facts. First, that within the ordinary limits of speed for merchant steamers (say, 13 knots) it would be possible to obtain as good results with a slightly greater draught and much more moderate proportions of length to breadth than are now commonly employed; and with a less area of immersed skin. The advantages of the more moderate proportions are greater handiness, the requirement of less structural strength and weight of hull, and the less serious loss of speed resulting from foulness of bottom; the gain in all these respects is not unimportant. Secondly, that if very high speeds have to be attained—say, speeds of 18 to 20 knots—it is preferable to decrease the length of the middle body, or to have none; increasing the lengths of entrance and run at the expense of the middle body, and making the extreme breadth greater. By this change all danger is avoided of reaching that critical speed at which the wave-making resistance grows abruptly.

Mr. Froude sums up his investigation as follows:—*

* See page 184 of the *Transactions* of the Institution of Naval Architects for 1876.

“In view of the importance of large carrying power
“combined with limited draught—a limitation which the
“Suez Canal has done much to emphasise—and I may add,
“in view of the practical sufficiency of what may be called
“moderate speed, the prevailing tendency to great length,
“including a long parallel middle body, is a fair result of
“‘natural selection.’ This form, if rationally treated, is
“perhaps, under the conditions indicated, the best adapted
“for commercial success; though where deep draught is
“unobjectionable, a shortened form with no parallel middle
“would be, as I have shown, unquestionably superior; or
“were it an object to obtain very high speed, without notable
“increase of resistance, parallelism of middle body would
“even with the longer form be inadmissible. The logic of
“the circumstances shapes itself thus:—Large displacement
“means large dimensions, somehow or somewhere; but the
“limitation of draught forbids enlargement of dimension
“except in the direction of length, since increased ratio
“of breadth to depth would involve an objectionably raised
“metacentre, and objectionable increase of skin; greatly
“extended length has, therefore, for mercantile purposes
“become essential to large carrying power. Now with a
“very long ship, if the ends are so far fined as in effect to
“limit the resistance to surface friction, the parallelism of
“the remainder clearly assigns a valuably increased carrying
“power to the ship as a whole; or, what comes to the same
“thing, secures a given carrying power with less total skin,
“and therefore less resistance at moderate speed.”

In ships of war, except in special classes, great length is objectionable because of the decrease in *handiness* which it involves; and this is especially the case in armoured ships intended to act as rams. The *Warrior* and *Minotaur* classes of the Royal Navy, with lengths of 380 and 400 feet (about $6\frac{3}{4}$ times the beam) stand alone; more recent types have lengths of from 280 to 330 feet (from $4\frac{1}{2}$ to $5\frac{1}{2}$ times the beam). It is acknowledged that these long fine vessels

are more economical performers under steam than their successors; but the greater proportionate resistance and larger engine-power of the shorter ships have been accepted because of their greater handiness and less first cost.* Moreover, the proportion of length to beam in these armoured ships frequently has to be determined by considerations other than those connected with either handiness or diminished resistance. In ships of the central-citadel type, for example, the beam is made proportionately greater than in ships with an armoured belt throughout the length in the region of the water-line; so that, when the unarmoured ends before and abaft the citadels are riddled, the ships may retain sufficient stability.

Unarmoured war-ships are generally furnished with good sail-power, a fact which (as we have seen in the case of the *Greyhound*) renders moderate length and considerable beam in proportion to length desirable. The swift cruiser classes, such as her Majesty's ships *Inconstant* and *Volage*, designed for high speed under steam, but also to keep the sea under sail alone, represent a class intermediate between the ordinary unarmoured type of fighting ship and the swift merchant steamers. They have a greater proportion of length to breadth than ordinary unarmoured ships, but considerably less than is common in merchant steamers: about $6\frac{1}{2}$ to 1 instead of 10 or 11 to 1. Even with these proportions the swift cruisers, with their large spread of sail, have no excess of stiffness; and the greater lengths of the merchant steamers, with their small proportionate breadths, give them such small metacentric heights that they are probably quite unfitted for carrying great sail-power.† All these statements simply amount to a repetition of that made previously; the designs

* See the discussion of this matter in *Our Ironclad Ships*, by Mr. Reed, C.B., late Chief Constructor of the Navy; and Chapter XIII. of this work.

† Mr. Denny, of Dumbarton,

speaking on this subject, said:—

“Every person who knows the merchant service, and the large merchant steamers, knows the fact that they are built with the least possible margin of stability.”

of war-ships are influenced by considerations of the qualities essential to their special services rather than by considerations of minimum resistance in proportion to displacement.

Summing up the foregoing remarks, it appears :—

(1) That *frictional resistance*, depending upon the area of the immersed surface of a ship, its degree of roughness, its length, and (about) the square of the speed, is not sensibly affected by the forms and proportions of ships : unless there be some unwonted singularity of form, or want of fairness. For *moderate* speeds, this element of resistance is by far the most important : for *high* speeds, it also occupies an important position—from 50 to 70 per cent. of the whole resistance, probably, in a very large number of classes, when the bottoms are clean ; and a larger percentage when the bottoms become foul.

(2) That *eddy-making resistance* is usually small, except in special cases, and amounts to some 8 or 10 per cent. of the frictional resistance. A defective form of stern causes largely increased eddy-making.

(3) That *wave-making resistance* is the element of the total resistance which is most influenced by the forms and proportions of ships. Its ratio to the frictional resistance, as well as its absolute magnitude, depend upon many circumstances ; the most important being the forms and lengths of the entrance and run, in relation to the intended full speed of the ship. For every ship there is a limit of speed beyond which each small increase in speed is attended by a disproportionate increase in resistance ; and this limit is fixed by the lengths of the entrance and run—the “wave-making features” of a ship.

The sum of these three elements constitutes the total resistance offered by the water to the motion of a ship towed through it, or propelled by sails ; and it becomes important to ascertain what is the magnitude of that resistance in proportion to the total weight of the ship. Until Mr. Froude conducted the towing experiments with her Majesty's ship

Greyhound, under the authority of the Admiralty, no exact information was accessible on this point; but these experiments have had a twofold result: they have furnished the actual resistances for the *Greyhound* when moving at various speeds, and have established the general correctness of the method by which Mr. Froude, from experiments with models, succeeds in predicting the resistances of full-sized ships. In addition, they have afforded valuable information respecting screw-propulsion, to which we shall refer in a later chapter.

The *Greyhound* weighs 1160 tons, and (as already explained) she is by no means an example of a form of small resistance. When she moved through the water, the vessel necessarily communicated motions to the water in her neighbourhood; the general character of these motions having been indicated in the preceding sketch of the stream-line theory. Changes in her own speed must have been accompanied by corresponding changes in these motions; and thus, in addition to the ship herself, a certain weight of water, which may be regarded as associated with her, must have undergone changes of speed corresponding to those impressed on the ship. Mr. Froude obtained data from which to estimate this weight of water, making special experiments for the purpose, and found it to be about one-fifth or one-sixth the weight of the ship. The *virtual* weight of the *Greyhound*, when towed, was, therefore, about 1400 tons. The tow-rope strain, or resistance, corresponding to various speeds was found to be as under. For purposes of comparison, the corresponding approximate results for the *Merkara* as also given; her actual weight being 3980 tons, and her virtual weight perhaps 4600 or 4700 tons.

Speeds of Ships.	Resistance (in Tons).	
	<i>Greyhound.</i>	<i>Merkara.</i>
4 knots	0·6	1
6 „	1·4	2·3
8 „	2·5	3·9
10 „	4·7	6
12 „	9	9

The full speed of the *Greyhound* is 10 knots; at that speed the resistance was only $\frac{1}{250}$ part of her actual weight; 13 knots is the full speed of the *Merkara*; the corresponding resistance (11.5 tons) is only $\frac{1}{350}$ part of the actual weight. It will be remarked that for very low speeds, below 8 knots, where frictional resistance constitutes almost the whole resistance, the greater surface of the bottom of the *Merkara* makes her resistance greater than that of the *Greyhound*; but at the higher speeds the greater wave-making resistance of the shorter and smaller ship makes her resistance gradually approximate to that of the *Merkara*.

One other illustration. Speaking of her Majesty's ship *Shah*, which steamed over 16 knots, Mr. Froude stated that the whole propulsive force at that extremely high speed was only 27 tons; less than $\frac{1}{200}$ part of the weight of the ship; and of this, surface friction accounted for no less than 15 tons.* Mr. Froude further remarked that, although the *Shah* carried a bow-wave 7 feet high, her whole resistance would have been represented by a wave only 30 inches high, exercising a sternward pressure. The stream-line theory furnishes, as we have seen, a rational explanation of these remarkable results; and no other theory of resistance can furnish a similarly satisfactory explanation of the very small resistance offered by water to the passage of well formed ships.

The problem to be solved by the naval architect is not to determine any exact geometrical form of least resistance of which he can make use in all cases, but in the design of each ship to select the forms and proportions which are compatible with the special conditions to be fulfilled, and which will make the resistance as small as possible. Even when thus narrowed, the problem is one of considerable difficulty; mainly because of our ignorance of the laws which govern the wave-making resistance. At present only a few of the more important conditions influencing wave-

* In his lecture at the Royal Institution in May 1876.

making have been determined, and these rather in a qualitative than a quantitative fashion; so that, without experiment, it is not now possible to ascertain what the value of this element of resistance will be in any proposed ship. In this fact is found one of the most valuable features of the experiments with models upon which Mr. Froude is engaged. Prior to the commencement of these experiments, many of the most eminent authorities on the subject, including Professor Rankine, were doubtful whether it was possible from experiments with models to obtain trustworthy results respecting the resistance of full-sized ships. Mr. Froude held the contrary opinion, and has since amply justified the correctness of his view. The best proof, however, is that furnished by the comparison of the results obtained from the towing experiments on the *Greyhound* with the results obtained from experiments on a model of the ship of dimensions $\frac{1}{16}$ the full size. In consequence of this success, Mr. Froude has given to the naval architect the power, from a comparatively inexpensive series of experiments on models, to arrive at a close approximation to the resistance of ships; and by similar experiments to test the effect upon the resistance of any variations in form and proportions, which may be possible under the special circumstances of each design. Mr. Froude has himself made many experiments of the latter class for the Admiralty, and thus done good service in the designs of various classes of war-ships. One example only can be given, and it is one of the most recent.*

In designing the *Medina* class of river-service gunboats for the Royal Navy, the draught of water was limited to less than 6 feet, and the full speed was fixed at 9 knots. The question arose which of two forms would be preferable: a vessel having a length of 110 feet and an extreme breadth

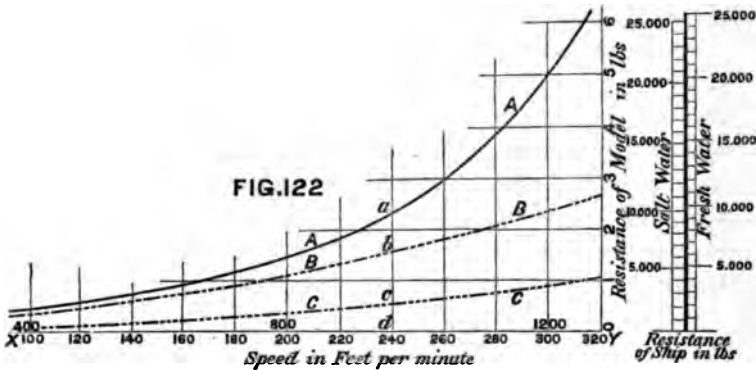
* See a speech by Mr. Barnaby, *actions* of the Institution of Naval C.B., Director of Naval Construction, Architects for 1876. reported at page 48 of the *Trans-*

of 26 feet, or a vessel of equal length, but 34 feet broad, and having greater fineness and length of entrance and run. Having experimented with models of the two forms, Mr. Froude reported that the broader vessel, with a displacement of 370 tons, would have only *two-thirds* as great resistance as the narrower vessel with a displacement of 350 tons. The results since obtained, on the measured-mile trials, with vessels built on the broader form, have fully confirmed the experiments made with the models. Without experiments the result could scarcely have been predicted; and it is a remarkable illustration of the fallacy of the opinion, formerly entertained very generally, that a greater area of midship section involved an increased resistance. The smaller actual resistance of the vessels with the larger midship sections was undoubtedly mainly due to the decrease in wave-making resistance produced by the longer and finer entrance and run. Whatever the explanation, there can be no question of the fact that this change of form was productive of a very advantageous diminution of resistance: saving one-third the engine-power required to attain the desired speed, and reducing the first cost of the machinery, as well as the cost of maintenance and repair during all the subsequent service of the numerous vessels in this class.

Apart from experiments with models, great uncertainty must always attend estimates of the resistance of new types of ships, and of the engine-power required to attain certain speeds. This is especially true of types designed for unusually high speeds lying quite outside the range of previous experience; but it is true also of all changes of type. As such importance attaches to these experiments, it is desirable that, before concluding this chapter, a brief account should be given of the process by which Mr. Froude educes the resistance of a full-sized ship from that obtained for the model. For this purpose, Mr. Froude makes use of a "scale of comparison," based upon the stream-line theory, and states it as follows:—"If the ship be D times the dimension of the model, and "if at the speeds $V_1, V_2, V_3 \dots$ the measured resist-

“ances of the model are $R_1, R_2, R_3 \dots$, then for “speeds $V_1\sqrt{D}, V_2\sqrt{D}, V_3\sqrt{D} \dots$ of the ship “the resistances will be $D^3R_1, D^3R_2, D^3R_3 \dots$. To “the speeds of the model and ship thus related it is “convenient to apply the term *corresponding speeds*.” This general statement will, perhaps, be better understood by an example ; for this purpose we cannot choose a better example than that published by Mr. Froude for the *Greyhound*, and illustrated by Fig. 122.

The curve AA in the diagram is termed a “curve of resistance;” measurements along the base-line XY repre-



sending speeds (in feet per minute), and the lengths of the ordinates drawn perpendicular to XY representing the resistances of a ship or model (in pounds) at the various speeds. To construct the curve, the model is towed at a certain speed—say, 240 feet per minute—and its resistance recorded by means of suitable dynamometrical apparatus ; a length (ad , in Fig. 122) representing this resistance is then set off along the ordinate drawn perpendicularly to XY at the point (d) corresponding to the speed. This process having been repeated for a considerable number of speeds, a series of points (such as a) is determined, and through these the curve AA is drawn. By simple measurement of an ordinate of this curve the resistance can be ascertained

at any speed within the limits over which the experiments extend. Having measured the immersed surface of the model, and ascertained by experiment its proper coefficient of friction, the frictional resistance can be easily calculated for each of the experimental speeds. The value of the frictional resistance at each speed is then set off from the base-line XY, on the same scale as was chosen for the total resistance curve AA, the length db representing the frictional resistance at the speed of 240 feet. A curve of frictional resistance (BB) is thus obtained for the model; and this operation completes all that need be done for the model; furnishing the data from which the resistance of the full-sized ship can be estimated.

In the case of the *Greyhound* the model was *one-sixteenth* of the full size of the ship: hence for the scale of comparison mentioned above, $D = 16$; $\sqrt{D} = 4$; and the "corresponding speeds" of the ship will be *four times* those of the model. In Fig. 122 the speeds in feet per minute marked *below* the line XY are speeds for the model; those marked *above* the line are speeds for the ship. For resistances at the corresponding speeds, the law stated above becomes—

$$\begin{aligned} \text{Resistance of ship} &= (16)^3 \times \text{resistance of model} \\ &= 4096 \times \text{resistance of model.} \end{aligned}$$

This change, therefore, simply amounts to an alteration in the scale of measurement of the ordinates of the curve AA; whatever length represents 1 lb. for the model must represent 4096 lbs. for the ship. The appropriate correction is made in Fig. 122 by the scale of "resistance of ship" drawn at the right-hand side of the diagram. It will be remarked that this scale provides for resistance in fresh water, as well as in sea-water, the salt-water resistance exceeding that for fresh water in the ratio in which the density is greater than that of fresh water; but this is not an important feature of the experiments, having been introduced only because Mr. Froude uses fresh water in his experimental tank. Having corrected the vertical scale of resistance in the manner

described, it would be possible to measure the resistance of the ship for any speed from the ordinates of the curve AA, were not a correction needed in the frictional resistance on account of the length of the ship exceeding that of the model so greatly.* This difficulty Mr. Froude meets by a simple device. The frictional resistance of the ship is calculated for the various speeds, making use of her actual coefficient of friction (allowing for her greater length), and these values are set off (on the proper scale, and on ordinates representing the corresponding speeds) downwards from the curve BB, which represents the frictional resistance of the model; through the points thus determined the curve CCC is drawn. Then, to determine the resistance of the ship at any speed, instead of measuring from the base-line XY, it is necessary to measure from the line CC.

Take, once more, the speed of 240 feet per minute for the model; this represents a speed of 960 feet for the ship (or about $9\frac{1}{2}$ knots per hour). The length ac on the ordinate, corresponding to this speed, represents the total resistance of the ship, on the proper scale; and the length bc represents on the same scale the frictional resistance of the ship, while cd represents the diminution of the frictional resistance of the ship as compared with the model, and will be seen to be of considerable amount.

This brief description of a method of investigation which is wholly due to Mr. Froude, and has been carried out by him to a thoroughly successful issue, will prove of value to readers who cannot avail themselves of the fuller published accounts; but all who can do so will be well repaid by the study.† What the outcome of these experiments may finally be, it is impossible to say, but the aims of Mr. Froude ‡ are

* See the remarks on page 439.

† See the *Transactions* of the Institution of Naval Architects, and *Proceedings* of the British Asso-

ciation, referred to in the preceding pages.

‡ In his lecture at the Royal Institution.

sufficiently expressed in the following passages:—"By these experiments I hope not only to obtain a great many comparisons, showing at once the superiorities of some forms to others, but to deduce general laws by which the influence of variation of form upon wave-making resistance may be predicted. Already indeed some most instructive positions concerning the operations of this cause of resistance have shaped themselves." . . . "I do not profess to direct anyone how to find his way straight to the form of least resistance. For the present we can but feel our way cautiously towards it by careful trials, using only the improved ideas which the stream-line theory supplies, as safeguards against attributing this or that result to irrelevant or rather non-existing causes."

In conclusion, it should be mentioned that in the actual propulsion of a ship the air exercises an appreciable resistance, especially if she is a rigged ship; and that the resistance of the water in a seaway must be different from that of smooth water, which alone has been considered in this chapter. Respecting the last-mentioned feature, it will suffice to say that the state of the sea and the motions of pitching and rolling vary so greatly at different times that any attempt to express the increase in resistance by an exact method would be hopeless, even if there were a complete theory for resistance in smooth water. Experience, however, confirms the accuracy of an opinion which would be formed on the most superficial investigation, viz. that great length, size, and weight in ships give them a greater power of maintaining their speed in a seaway. The regularity of the passages made by the large Transatlantic steamers, under very various conditions of wind and weather, supply the best possible illustration of this general statement, which has, however, to do with propulsion rather than with resistance.

As to air resistance, there have been very few trustworthy experiments. Mr. Froude, in his experiments with the

Greyhound, which was not rigged at the time, found that, when the speed of the wind past the ship was 15 knots per hour, it produced an effect on the hull measured by a force of 330 lbs. For other speeds of wind past the ship, it was assumed that the effect varied as the square of the speed; and it need hardly be added that in the case where a ship is steaming head to wind air resistance must be greatest, since the speed of the wind past the ship then equals the sum of her own speed and that of the wind. The absolute force of the air resistance in the *Greyhound* was thus found to be small; but if the vessel had been masted and rigged, the resistance would have been greater. Mr. Froude does not expressly state, in his report on this experiment, what scale of allowance he employed in estimating the additional resistance due to the passage of the masts and rigging through the air; but from the particulars which he has since furnished to the Author, it appears that the total resistance of the masts and rigging was taken about equal to that of the hull. At a speed of 10 knots through *still air*, this would give a total air resistance of about 300 lbs., the corresponding total of water resistance being about 10,200 lbs.; making the air resistance about $\frac{1}{34}$ part of the water resistance. If the ship steamed head to wind at a speed of 8 knots, the actual speed of the wind being 7 knots, it would pass the ship with a relative speed of 15 knots; the air resistance would then probably have a total of about 650 lbs., whereas (if the water were smooth) the total water resistance would be about 5600 lbs., the air resistance rising to about $\frac{1}{8}$ of the water resistance. These results may not be exactly correct, but they are sufficiently so for illustrative purposes; they explain the considerable decrease in speed in ships—especially rigged ships—steaming head-to-wind; and they are so considerably in excess of what would have been predicted on purely theoretical grounds as to indicate the desirability of further experiments on the air resistance to rigged ships. Up to the present time, we have little infor-

mation of an exact or trustworthy character on this important subject.

The experiments required are very simple. All that is necessary is to allow a ship to drift before the wind, to note the uniform speed which she will ultimately attain through the water, and to measure the velocity of the wind past the ship; her condition aloft must also be recorded, as to spars on-end, running rigging rove, &c. The water should be approximately smooth, and the ship should owe her drift simply to the air pressure, not to tides or currents. The resistance of the water at the uniform speed of drift must then exactly equal the total air resistance; and this water resistance could be ascertained by other experiments made either with the ship or with models. Accuracy would be increased and more valuable information obtained if the same ship were made the subject of several experiments, including two sets: one made with the same condition as to spars and rigging aloft, but with different forces of wind; the second set made with different conditions of rig, while the actual speed of the wind remained constant. This is a matter which will be likely to commend itself to the attention of naval men when they learn the imperfect condition of our present knowledge of the subject.

As to the air resistance on the hull only, there appears good reason for adopting the rule which Mr. Froude has suggested, viz. that, if the above-water portions of the hull are projected back upon the midship section of a ship, and the total area (A) inclosing these projections is determined, then the air resistance on that area (A) will approximately equal the air resistance on the hull for any assumed speed. In the *Greyhound* the area A was somewhat less than 400 square feet; Mr. Froude has ascertained by experiment that at a speed of 1 foot per second the air resistance per square foot on a plane area is about equal to $\frac{1}{10000}$ lb. A speed of 15 knots per hour equals about $25\frac{1}{2}$ feet per second; and since the air resistance varies as the square of the speed, the speed of 15 knots should correspond to a pressure of about 1 lb. per

square foot of area. Hence the total air resistance on the *Greyhound* for a speed of 15 knots past the ship should be about 400 lbs. by this law; and by experiment it was determined to be 330 lbs. This approximate rule may be found useful for purposes of comparison between different types of ships; and in mastless ships it will give a fair estimate of the total air resistance at any assigned speed of wind past the ships. Rigged ships present a more difficult problem, which can be best dealt with experimentally in the manner described above.

CHAPTER XII.

PROPULSION BY SAILS.

THE efficient management of a ship under sail furnishes one of the most notable instances of skilful seamanship. In different hands the same ship may perform very differently. Changes in stowage and trim also affect the performance; but such changes as an officer in command can make are necessarily limited in their scope and character; and some ships can never be made to sail well, having some radical fault in their designs. Without intruding upon the domain of seamanship, the naval architect requires, therefore, to study very carefully the conditions of sail-power, and the distribution of sails in a new design, if the completed ship is to be fairly successful. His success or failure greatly depends upon the possession of information respecting the performances and sail spread of ships of similar type and rig; having such information, the process by which the total sail spread and the distribution of the sail are determined in the new ship is by no means difficult or complex. Taking the exemplar ships, and the reports on their sailing qualities, an analysis is made of the sail areas, the distribution of the sail longitudinally and vertically, the transverse stability, and some other particulars. Furnished with these data, and having regard to the known qualities of the completed ships, it is possible to secure similar, or perhaps improved, performance in the new design. Apart from such experience, however, the naval architect would be unable to be equally certain of obtaining good results; and in cases where great

strides are taken in a new design, away from the sizes and proportions or sail plans of existing ships, the arrangement of the sail-power cannot but be, to a large extent, experimental. Illustrations of this are to be found in the earlier ironclads of the Royal Navy, such as the *Achilles* and *Minotaur* classes, in which the sizes, lengths, and proportions of length to breadth were all much greater than in preceding ships. When first fitted with four masts, the *Achilles* did not perform well under sail; but as now arranged with three masts, she stands high among the ironclads. The *Warrior*, on the other hand, a ship of the same class as the *Achilles*, proved successful under sail from the first; having only three masts. In fact, although the general principles of propulsion by sails were long ago formulated, and although many eminent mathematicians and naval officers have endeavoured to assist the naval architect by constructing general rules for guidance, there is even now no accepted theory fully representing the conditions of practice. In this chapter attention will be confined to a few of the fundamental principles of propulsion by sails, and to the simple rules which are commonly observed by naval architects in arranging the sails of a ship.

Suppose a fixed plane surface to be exposed to the action of a wind of known velocity, blowing steadily at right angles to the plane; the pressure upon it will then be represented by the expression—

Pressure on plane (in lbs.) = $C \times (\text{velocity})^2 \times \text{area of plane}$,

where C is a constant quantity determined by experiment. This law is not exact, but is sufficiently so for practical purposes. Some doubts exist as to the proper value to be assigned to C ; if the velocity is expressed in feet per second and the area in square feet, then, according to the best data hitherto available,*

* See a table of wind speeds and pressures at page 90 of *Shipbuilding, Theoretical and Practical*; also the “wind scales” at page 41 of the *Barometer Manual* of the late Admiral Fitzroy.

$$\left. \begin{array}{l} \text{Pressure on one square foot} \\ \text{of area on plane . . .} \end{array} \right\} = 0.00234 \text{ lb.} \times (\text{velocity})^2.$$

Lieutenant Paris, of the French navy, conducted an extensive series of experiments on the pressures of winds of various speeds, in connection with his observations on waves, and the mean coefficient deduced from his published results very nearly agrees with that stated above, being 0.00239.* These observations on ship-board, however carefully conducted, must be subjected to many disturbing causes; and, moreover, there must be great difficulty in determining accurately the velocity of the wind past the ship and past the anemometer. For these reasons it appears preferable to substitute for the motion of the wind past a plane the motion of a plane through still air, in order to obtain accurate unit pressures. This method has been employed by Mr. Froude, with the aid of his delicate automatic apparatus for measuring resistance, and we have been favoured with some of the results. The coefficient thus obtained is about 28 per cent. less than that obtained by previous experimenters; and it gives—

$$\left. \begin{array}{l} \text{Pressure on one square foot} \\ \text{of area on plane . . .} \end{array} \right\} = 0.0017 \text{ lb.} \times (\text{velocity})^2.$$

According to the earlier experiments, a pressure of *one pound* per square foot of surface corresponds to a speed of wind of about 12 knots per hour; according to Mr. Froude, that speed would be about 14 knots per hour. The latter result appears more trustworthy; and it indicates that in a “fresh breeze” or “top-gallant sail wind” (Force 5 to 6) the normal wind pressure per square foot is about 1 lb.

The classification of winds is a subject lying outside our present field, but it may be stated that authorities agree in assigning a speed of from 60 to 100 knots per hour to a “hurricane” (Force 12), the corresponding pressures being

* See Chapter V. page 177, and the full description of the observation in vol. xxxi. of the *Revue maritime*.

from 18 to 50 lbs. per square foot. The "storm-wind" (Force 11) would have a speed of 45 to 50 knots, and a pressure of from 11 to 13 lbs.; the "heavy gale" (Force 10) would have a speed of about 40 knots, and a pressure of 8 to 9 lbs.; the "strong gale" (Force 9), a speed of about 34 knots, and a pressure of about 6 lbs.; the "fresh gale" (Force 8), a speed of about 28 knots, and pressure of about 4 lbs.; the "moderate gale" (Force 7), a speed of about 23 knots, and a pressure of about 2½ lbs.; the "strong breeze" (Force 6), a speed from 15 to 20 knots, with a pressure from 1 lb. to 2 lbs.; and the "fresh breeze" (Force 5), the upper limit of 1 lb. pressure, corresponding to a speed of 14 knots as above. All these pressures are supposed to act on a plane area of one square foot placed at right angles to the direction of the wind.

If this plane area were placed obliquely to the direction of the wind, the pressure upon it would diminish; but the law of the decrease does not appear to have been ascertained. Formerly it was supposed that for any angle of inclination α of the plane to the direction of the wind, or "angle of incidence,"

Wind pressure = normal pressure (due to velocity) $\times \sin^2 \alpha$.

This law, however, is known to be incorrect, making the wind pressure less than the true pressure, especially for small angles of incidence. Mr. Fincham (in his treatise on Mastng Ships) gave the results of experiments made by the French Academy of Sciences, on the comparative resistances of water to the motion of wedge-shaped bodies, the plane surfaces of the wedges having been set at various angles of obliquity; and he proposed to use these results in estimating the effective pressure of the wind acting obliquely on the sails. According to these experiments, the law of the "square of the sine of the angle of incidence" above stated held very closely up to 70 degrees, but for smaller angles of incidence the actual pressure exceeded the pressure given by this law, and gradually approached the product of the normal pressure by the sine of the angle. When the angle of

incidence was about 25 degrees, the plane being inclined 65 degrees from the normal position, the law of the sine held exactly. The results for greater inclinations need not be given; they appear inexplicable. In fact, these experiments do not, and could hardly be expected to, furnish any trustworthy information as to the effective pressure of wind on the sails.*

Apart from experiment, it seems reasonable to suppose that the wind pressure on a plane placed obliquely should vary nearly as the sine of the angle of incidence, within the limits which are important in practice; and although this law may not be exact, it will be sufficiently so for practical purposes.

A sail acted upon by the wind either normally or obliquely would not remain plane, but would become concave on the windward side, or would "belly out." According to the experiments of M. Thibault (quoted by Professor Rankine), "the impulse of the wind upon a sail of the usual concave figure is very nearly equal to its impulse on an equal area of plane surface." But experience appears to show that the more nearly plane the surface of a sail can be kept, the greater will be the propelling force derived from the wind pressure upon it. "All slack canvas," says Mr. Fincham, "whether sailing by the wind or large, lessens the effect of the sail; and even before the wind, when the slack reef is out, the power which acts on the sail will be reduced very considerably on the curved surface; less even than the base of the same curve, or than if the sail were set taut-up, but reduced to the same hoist or distance between the yards as when slack."

Sails attached to ships are not fixed in position like the plane and sail just considered, but necessarily move with the ship. Hence, in dealing with the propulsive effect of a

* See the details given by M. Bourgois, in his *Mémoire sur la Résistance de l'Eau*. The experi-

ments were conducted by Bossut, Condorcet, and D'Alembert.



wind of which the absolute direction and force are known, it is necessary to take account also of the motion of the ship; or, as it is usually expressed, it is necessary to determine the *apparent* direction and velocity of the wind. This can be done easily in any case for which the course and speed of the ship, as well as the true direction and velocity of the wind, are known; the simple general principle being that the apparent motion of the wind is the resultant of the actual motion of the wind, and a motion equal and opposite to that of the ship. A vane at the mast-head would indicate the apparent direction of the wind, and not its true direction; an anemometer on board would measure the apparent velocity of the wind.

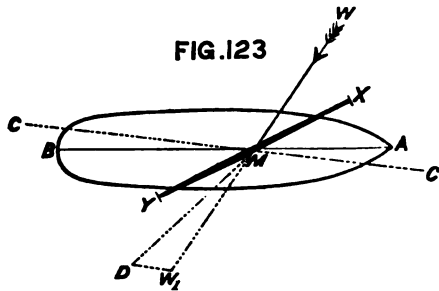
Take the simplest case: a vessel with a single square sail running "dead before" the wind. If the speed of the wind is V feet per second, and that of the ship v , as the direction of both motions is identical, the resultant of the actual speed of the wind and the reversed motion of the wind will be $V - v$ feet; and this apparent motion will govern the propulsive effect. For example, let the speed of the wind be 15 feet per second; that of the ship 5 feet per second; the apparent speed of the wind will be 10 feet ($15 - 5$); and the pressure per square foot of area of sail will be given by the equation:—

$$\text{Pressure} = \frac{17}{10000} \times 10^2 = \frac{17}{100} \text{ lb.}$$

The pressure of this wind on a *fixed* sail would be about $2\frac{1}{2}$ times as great. From this simple illustration it will be seen that it is most important to determine accurately the apparent motion of the wind.

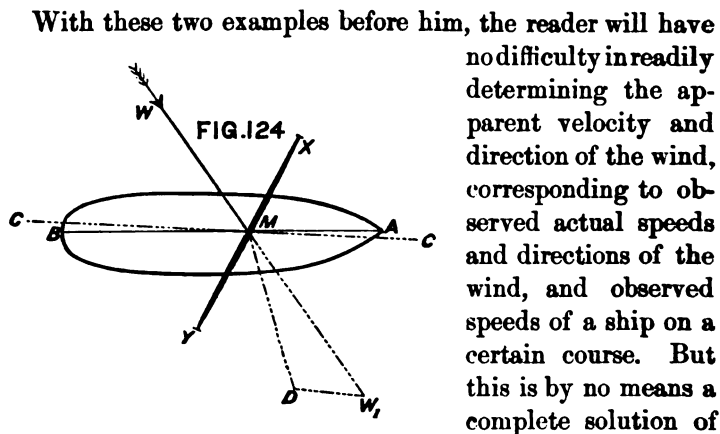
As a second illustration, take the case of a vessel sailing on a wind close-hauled, with the wind *before* the beam. To simplify matters, let a single square sail be considered, set on the yard marked XY in Fig. 123. AB represents the middle line of the ship, the outline of the "plan" being indicated. The line WW_1 represents the *actual* direction of the wind; let MW_1 represent (on a certain scale of feet) its

velocity. The line CC shows the course of the ship; and on W_1D (which is drawn parallel to CC) a length W_1D is



set off to represent a motion equal and opposite to that of the ship, the same scale being used for W_1D as was employed for the length MW_1 . Join MD ; then MD represents in magnitude and direction the apparent velocity of the wind. MD is *greater* than the actual velocity MW_1 ; but its direction makes a *more acute angle* with the sail on XY than does the actual direction WW_1 .

The case of a ship sailing with the wind abaft the beam is illustrated in Fig. 124; the reference letters being similar to those in Fig. 123, no description is needed. Here the resultant MD is *less* than the actual velocity MW_1 ; but, as in the previous case, it makes a more acute angle with the sail on XY .



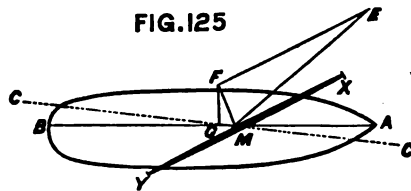
With these two examples before him, the reader will have no difficulty in readily determining the apparent velocity and direction of the wind, corresponding to observed actual speeds and directions of the wind, and observed speeds of a ship on a certain course. But this is by no means a complete solution of the question which presents itself in practice, and takes the form:—Given a certain actual direction and speed

of wind, and the sail area and angle of bracing for the yards, what will be the course of the ship, and her speed of advance? To answer the question fully and correctly requires data beyond those at present possessed; but an approximate solution is possible.

Reverting to the case of a ship sailing on a wind (Fig. 123), suppose the apparent direction and speed of the wind to have been determined; and further suppose the pressure on the sail corresponding to this apparent wind to be known, its line of action being horizontal. In Fig. 125, let EM represent this pressure, its line of action corresponding to MD produced in Fig. 123. The pressure acting along EM may be regarded as the resultant of two components: one (EF) acting parallel to the sail XY , and not sensibly affecting it; the second (FM) acting normally to the sail. This normal

pressure, again, may be regarded as made up of three pressures: one of these (shown by GM) acts longitudinally; the other (FG) acts athwartships, and the third acts vertically, at right angles to the other two, which act horizontally. For moderate angles of steady heel under sail, such as are common in ships, the vertical component of the normal pressure is not of much importance, and it is usually neglected. In all cases, however, it tends to increase the immersion of a ship; and in some cases, when the angle of heel is considerable, this effect may be noteworthy. Let it be assumed for the present that only the horizontal components FG and GM require to be considered.

When the motion of the vessel has become uniform under the action of a wind of constant force and unchanging direction, it will take place along some line, such as CC , lying obliquely to her middle line AB . This motion may be resolved into two parts: one, a direct advance, in the line AB ,



at a certain speed; the other, a drift to leeward perpendicularly to AB. To the uniform speed of direct advance will correspond a certain *resistance* of the water, the general character of which agrees with that sketched in the preceding chapter, except in one particular. In that chapter the ship was supposed *upright*; when the forms of her water-lines would be symmetrical about the middle-line plane; but under sail a vessel heels, the symmetry of form is destroyed, and the character of the stream-line motions may be so affected as to cause a somewhat greater resistance than when the vessel was upright. When the ship has attained a uniform speed, the direct resistance of the water will be balanced by the sum total of the longitudinal components of the wind pressures (such as MG, Fig. 125) on all the sails. This resultant wind pressure will act along a line at a considerable height above the equal and opposite horizontal component of the water resistance; and, therefore, these two forces will form a couple tending to change the trim and depress the bow; but (as explained at page 88) the longitudinal stability of a ship is relatively so great that very small changes of trim usually take place. As an example, suppose the *Greyhound* sailing at a speed of 6 knots; her resistance would be about $1\frac{1}{2}$ ton, and the arm of the couple would be about 60 feet; the moment would, therefore, be about 90 foot-tons, corresponding to a change of trim of less than *one inch*.

To the uniform speed of drift to leeward will also correspond what may be termed a *lateral* resistance, which will be equal and opposite to the sum total of all such transverse components of the wind pressure as FG, Fig. 125. It has already been explained that these two forces form a couple which will heel the ship until a transverse inclination is reached at which the moment of stability equals the moment of the couple.* This angle of heel under canvas

* See page 62 and Fig. 29, where the forces P represent the resultant of all the transverse components of the wind pressure, and the equal and opposite force of lateral resistance.

varies according to the "stiffness" of the ship in relation to her spread of sail and the force of wind; hereafter we shall explain the rule which is used for determining the "power to carry sail" in various classes of ships.

Combining these two motions—advance along the line of keel due to the sum total of the longitudinal components of the wind pressure, and drift to leeward due to the sum total of the transverse components—it will be seen that the actual course of the ship must be along some line, such as CC, in Fig. 125. The angle made by this line with the line of keel (AB) is called the "angle of leeway," and in good examples of sailing ships it is said rarely to exceed from 8 to 12 degrees when sailing close-hauled, although in less successful vessels the angle is much greater. The magnitude of the angle depends upon the ratio of the velocity of advance, or headway, to the velocity of drift, or leeway; and these velocities are governed by varying conditions requiring consideration.

Suppose, for example, a ship close-hauled, as in Fig. 125, with her yards braced to a certain angle with the keel-line, to be instantaneously at rest when the wind strikes upon her sails. For that instant the real direction of the wind is also its apparent direction, since the vessel is motionless; and the resultant pressure will have longitudinal and transverse components, which are *unbalanced pressures*; the result will be that the vessel will acquire headway and leeway. At first her motion will be slow, but it will gradually increase, because at these low speeds the direct and lateral resistances of the water at any instant will be much less than the longitudinal and transverse components of the wind pressure on the sails. The motion will, therefore, continue to be accelerated, both ahead and to leeward, until in each direction the corresponding component of the wind pressure is opposed by an equal and opposite fluid resistance. In obtaining these components, allowance must of course be made for the apparent direction and velocity of the wind at each instant; and, finally, when uniform motion and a definite angle of

leeway have been reached, the conditions illustrated by Figs. 123 and 125 will be in force. The actual direction and velocity of the wind remain constant, during all these changes in its apparent direction and propulsive effect.

From the foregoing explanations it will appear that the greatest care must be taken in determining the angle to which the yards shall be braced, or the sails set, in order to secure the greatest speed when sailing on a wind. This is pre-eminently a question of seamanship; but it has engaged the attention of many eminent mathematicians, whose investigations still remain on record. All these investigations were based upon certain assumptions, as to the effective pressure of a wind acting obliquely upon the sails, the apparent direction and velocity of that wind being known. In Fig. 125, for example, if EM represents in direction and magnitude the "pressure due to the apparent velocity" of the wind—that is, the pressure it would deliver upon a plane area, say, of one square foot placed at right angles to EM—the effective pressure (FM) would, according to the law formerly received, have been expressed by $EM \sin^2 EMX$. It has been shown that this law cannot be accepted; and therefore the elaborate deductions which have been made from investigations based upon it have now little interest. Even if the true law were determined, mathematical inquiries could never be trusted to replace the judgment of the sailor in determining the most efficient angle for bracing the yards or trimming the sails. So many varying circumstances have to be encountered in the navigation of a sailing vessel that theory can never be expected to take complete cognisance of them all. The decision as to the best mode of handling a sailing ship must always rest, where it has always rested, in the hands of her commander. One thing, however, is obvious from the preceding remarks, viz. that it is a very great advantage to a ship in sailing close-hauled to be able to brace her yards up very sharply, in order to secure the most advantageous angle of incidence (EMX, Fig. 25) of

the wind upon the sails, and thereby render the propelling force as great as possible under the circumstances. In this respect, square-rigged vessels compare unfavourably with fore-and-aft-rigged vessels, the shrouds, stays, &c. imposing serious limitations upon the bracing of the yards. After bringing together and digesting a great mass of facts respecting sailing ships, Mr. Fincham summed up this matter as follows:—"When close-hauled, experience has shown "that the yards in square-rigged vessels can seldom be "braced sufficiently sharp to obtain the most advantageous "position for plying to windward." He also gave from 13 to 17 degrees with the keel as the angles which the sails of a fore-and-aft-rigged vessel seldom exceed on a wind, such angles being less than can be reached in all, or nearly all, square-rigged vessels.

The tangent of the angle of leeway (AMC, in Fig. 125) equals the ratio of the speed of drift to the speed ahead. These speeds depend upon various conditions, some of which have been mentioned. It will be evident, for example, that variations in the angle (AMX) to which the yards are braced will affect both the absolute and the relative values of the transverse and longitudinal components of the wind pressure. If the normal pressure (FM) were known, we should have—

$$\frac{\text{Transverse pressure}}{\text{Longitudinal pressure}} = \frac{FG}{GM} = \cot \text{AMX}.$$

Suppose AMX = 30 degrees: then

$$\text{Transverse pressure} = \text{longitudinal pressure} \sqrt{3}.$$

The speeds ahead and to leeward clearly do not depend simply upon this ratio of the longitudinal to the transverse wind pressures; they are governed far more by the relative resistances of the water to the motion of the ship ahead and to leeward. Even if the two pressures were exactly equal, the resistance to leeway would be much greater than the resistance to headway, and the speed of advance would much

exceed the speed of drift. In every case, for uniform motion, these speeds must develop resistances exactly balancing the respective components of the wind pressure; so that, when these components are known, it is still necessary to discover the speeds corresponding to resistances equalling the known pressures, in order to fix the angle of leeway.

In the preceding chapter resistance to headway has been fully discussed; only a brief explanation is required respecting resistance to leeway. When a ship drifts to leeward, the keel, deadwood, bilge-keels, and approximately plane and upright portions of the bottom experience resistance resembling that offered to a plane surface moving at right angles to itself. The curved and approximately cylindrical portions of the ship also experience resistance of a somewhat similar character, although the particles of water can glide past them with less abrupt changes of motion. At present we cannot obtain exact measures for the lateral resistance, such as are available for head resistance. A rough approximation may, however, be made to the lateral resistance of a ship by comparing it with that of the immersed part of the longitudinal middle-line plane, or plane of the masts. It need hardly be stated that two ships for which this plane area was the same might experience different lateral resistances, owing to different degrees of "fineness" of form, or different areas of keel, bilge-keels, deadwood, &c.; but this rough measure will suffice for our present purpose, and enable us to illustrate the great excess of lateral over direct resistance.

Assume this method to hold in the case of the *Greyhound*, and that the transverse and longitudinal components of the wind pressure are of equal amount. The immersed area of the middle-line plane in that ship is about 2300 square feet. Colonel Beaufoy proved that a plane moving at right angles to itself at a speed of 10 feet per second experienced a resistance of 112 lbs. per square foot of area. Let it be supposed that this unit of resistance applies in the example chosen, that the resistance varies as the square of the speed,

and that the speed of drift is *one knot per hour*, or 1.688 feet per second. Then

$$\text{Lateral resistance} = 2300 \times 1 \times \left(\frac{1.688}{10}\right)^2 \times \frac{1}{20} = 3.28 \text{ Tons}$$

This equals the resistance to headway at a speed of about 9 knots; so that under the assumed conditions the angle of leeway would be about 6 degrees only. The components of the wind pressure will but seldom be equal to one another; this, however, will not affect the general statement that the great proportionate value of the lateral resistance keeps the angle of leeway small. Suppose, for example, the transverse component to be *twice* as great as the longitudinal: then the speed of headway corresponding to the speed of drift of one knot per hour must develop a direct resistance of about 1.64 ton; and by experiment this is found to be about $6\frac{1}{2}$ knots, making the angle of leeway about 9 degrees.

Various devices are employed in order to increase the lateral resistance, and to diminish leeway. In shallow-draught or flat-bottomed vessels, "lee-boards" are often fitted; these boards can be dropped at the sides of the vessels, and made to project beyond the bottom. Sliding keels, or "centre-boards," are sometimes fitted so as to be housed in recesses formed within the vessels, or to be lowered below the bottom. Very deep keels and great rise of floor are also commonly adopted in yachts designed for racing, for the same purpose.

When a ship sailing at a uniform rate, under the action of a wind of which the force and direction are constant, maintains an unchanged course without the use of the rudder, it is clear that the resultant pressure of the wind on the sails and the resultant resistance of the water cannot form a couple tending to turn the vessel. Under these circumstances, therefore, these equal and opposite forces must act in the same vertical plane. If it were possible to determine the line of action of the resultant resistance for

any assumed speed, on a certain course in relation to the direction of the wind, then it would follow that the sails should be so trimmed as to bring the line of action of the resultant wind pressure into the same vertical plane with the resultant resistance, if the course is to be maintained without the use of the rudder. The less the rudder is used in maintaining the course, the less will the speed of the ship be checked thereby. In practice, however, the theoretical conditions cannot be fulfilled, because the line of action of the resultant resistance cannot be determined, in the present state of our knowledge, even under given conditions of speed and course; because that line of action changes its position with changes in the speed, the angle of leeway, and the transverse inclination of the ship, not to mention the changes consequent on alterations in the force and direction of the wind; and because it is not possible to determine accurately the line of action of the resultant wind pressure on the sails, when set in any given position. The problem which thus baffles theory is however solved more or less completely in practice; the skilful seaman varies the spread and adjustment of his sails in order to meet the changes in the line of action of the resistance. In a well-designed vessel, the distribution of the sail is such that the commanding officer has sufficient control over her movements under all circumstances. Some vessels, however, are not so well arranged for sailing purposes, and in them "ardency" or "slackness" when sailing on a wind may be practically incurable.

"Ardency" is the term applied when a vessel tends to bring her head up to the wind, and she can only be kept on her course by keeping the helm a-weather; the resultant resistance must then act before the resultant wind pressure. The contrary condition, where the resultant resistance acts abaft the resultant wind pressure, and makes the head of the ship fall off from the wind, is termed "slackness," and can only be counteracted by keeping the helm a-lee. Of the two faults, slackness appears the more serious: for a vessel thus

affected seldom proves weatherly. To avoid excess in either direction, the naval architect distributes the sails of a new ship, in the longitudinal sense, by comparison with the arrangements in tried and successful vessels, conforming to some simple rules which will be stated hereafter.

Passing from these general considerations respecting propulsion by sails to the practical problems which the naval architect has to solve in determining the sail spread appropriate to any new design, it becomes necessary to note an important distinction. In all his calculations the naval architect is accustomed to deal only with *plain sail* or *working sail*, and not to include all the sails with which a ship may be furnished. Plain sail may be defined as that which would be commonly set in a fresh breeze (Force 5 to 6), having a pressure of about 1 lb. per square foot of canvas. The following tabular statement shows concisely what sails would generally be included in the plain sail of various classes of ships; and although the sails not included are of value, especially in light winds, yet it will be obvious that those named in the table are very much more important.

Style of Rig.	Plain sail.
Ship . . .	Jib, fore and main courses, driver, three topsails, and three top-gallant sails.
Barque. . .	As ship, except gaff-topsail on mizen-mast.
Brig . . .	As ship, exclusive of mizen-mast.
Schooner . .	Jib, fore stay-sail, fore-sail, and main-sail.
Cutter . . .	Jib, fore-sail, and main-sail.

Notes to Table.

In brigs, one-half the main course and the driver are sometimes taken instead of the whole of the main course.

In schooners, the fore topsail is sometimes included.

In yawls, besides the sails named for cutters, the gaff-sail on the mizen is included.

It will be understood in what follows that, except in any cases specially mentioned, we are dealing only with plain sail, and not with total sail area.

In arranging the plan of sails for a new ship, the naval architect has to consider three things: (1) the determination of the total sail spread required to obtain the desired speed under certain assumed conditions; (2) the proper distribution of this sail in the longitudinal sense, including the adjustment of the stations for the masts; (3) the proper distribution of the sail in the vertical sense, in order that the vessel may have sufficient stiffness. On each of these points we now propose to make a few remarks, taking them in the order they have been named.

First: as to the determination of the *total area* of plain sail in a new design.

Other things being equal, the propelling effect of the sails of a ship depends upon their *aggregate area*. Wind pressure and the management of ships are necessarily varying quantities. Hence for equal speeds the area of plain sail in two ships should be made proportional to their respective resistances at those speeds. For speeds such as are ordinarily attained under sail it appears not unreasonable to assume that frictional resistance furnishes by far the larger portion of the total resistance; and when the bottoms of two ships are equally rough—having the same coefficient of friction—the frictional resistances will be proportional to the immersed or “wetted” surfaces of the bottoms. Further, if the two ships are similar in form, but of different dimensions, the wetted surfaces will be proportional to the *two-thirds* power of their displacements; for these surfaces will be proportional to the *squares* of any leading dimension—say the length—while the displacements will be proportional to the *cubes* of the same dimensions. Put in algebraical language, if W_1 be the displacement of one ship, S_1 the wetted surface, and A_1 the area of plain sail; while W_2 , S_2 , and A_2 are the corresponding quantities for another similarly formed ship: then for equal speeds under sail we must have,

$$\frac{S_1}{S_2} = \frac{A_1}{A_2} = \left(\frac{W_1}{W_2}\right)^{\frac{2}{3}}.$$

Suppose, for example, that $W_1 = 8W_2$; then

$$\frac{A_1}{A_2} = \left(\frac{8W_2}{W_2}\right)^{\frac{2}{3}} = 8^{\frac{2}{3}} = 4; \text{ or, } A_1 = 4A_2.$$

For the case where a higher or lower speed is desired in the new ship than the speed of the typical ship or ships used as examples, a slight modification of the preceding formula is required. Let it be assumed, as may fairly be done, that the resistance of these ships varies as the square of the speeds, within the limits of speed considered. Further let it be assumed that the effective pressure (per square foot) of the wind on the sails is the same for both ships.* Then, if V_1 and V_2 be the maximum speeds, and the other notation remains as before, we have,

$$A_1 = k (W_1)^{\frac{2}{3}} \times V_1^2,$$

$$A_2 = k (W_2)^{\frac{2}{3}} \times V_2^2,$$

where k is a constant, and the same for both ships. Hence

$$\frac{A_1}{A_2} = \left(\frac{V_1}{V_2}\right)^2 \times \left(\frac{W_1}{W_2}\right)^{\frac{2}{3}}$$

is an equation from which the new sail spread (A_2) may be determined approximately.

The first rule for proportioning sail spread, although obtained under the limitations stated above, is on the whole as satisfactory as any that has been proposed for comparing the sail-power of ships not similar in form, provided the dissimilarity is not very great. No doubt it would be pre-

* This latter assumption is not strictly correct; since the difference in speed must produce some difference in the apparent direction and velocity of the wind. The character of the correction required

will be understood from the remarks previously made (page 475); but it is never made in practice, the common plan being to suppose the speeds V_1 and V_2 equal, and to use the first formula.

ferable in cases lying outside these limits to determine the resistances by model experiments, and then to proportion the sail areas to these resistances in order to secure equal speeds. But this has never yet been done, and as steam propulsion is gaining so much upon propulsion by sails, it is never likely to be done with a view to influencing practice. Hence it has been customary of late years to adopt the foregoing rule in comparing the sail-power of different ships belonging to the Royal Navy.

Formerly it was the practice to proportion the area of plain sail to the *area of the water-line section* of ships; and this would agree with the foregoing rule so long as the condition of similarity of form was strictly fulfilled. But when the vessels compared are somewhat dissimilar in form and proportions, it becomes preferable to express the sail area as a multiple of (displacement) ^{$\frac{2}{3}$} rather than as a multiple of the area of the water-line section. Very similar remarks apply to another method once commonly used, in which the area of plain sail was proportioned to the area of the *immersed midship section*; a plan which was applicable only when the vessels compared were similarly formed. Still another method of stating the sail spread was to express it as a multiple of the displacement (in tons). A ship of 3500 tons displacement with 24,500 square feet of plain sail would be described as having 7 square feet of canvas per ton of displacement. This method, however, erred in the assumption it made that resistance varied with the total weight of a ship—an assumption of which the fallacy has been exposed in the preceding chapter.

A full statement of the sail spread considered desirable in different classes of ships would occupy space far exceeding the limits at our disposal. The treatise on Masting Ships published some years ago by Mr. Fincham contains detailed information on the subject that can still be studied with advantage, embracing, as it does, not merely the particulars of sailing ships of all classes, but also those of the classes of unarmoured steam-ships of the Royal Navy designed before

the ironclad reconstruction began.* In this work the area of plain sail is expressed as a multiple of the area of the water-line section, and the following figures may be interesting. For ship-rigged vessels the area of plain sail is said to have been from 3 to 4 times the water-line area; for brigs and schooners from $3\frac{1}{2}$ to $3\frac{3}{4}$ times, and for cutters from 3 to $3\frac{1}{2}$ times. These ratios were for sailing vessels; in their unarmoured successors, possessing both steam and sail power, the ratio is not so high, and in a great many ship-rigged vessels falls to 2 or 3. In yachts of the present day the ratio varies from $3\frac{1}{2}$ to $5\frac{1}{2}$, $4\frac{1}{2}$ being a common value in vessels having a great reputation for speed. In the armoured ships of the Royal Navy the corresponding ratio is in some cases a little above and in others a little below 2.

Comparing these various classes by the ratio which the sail spread bears to the two-thirds power of the displacement, the following results may be interesting. The numbers represent, for some typical ships of war, the quotient:—

$$\text{Sail spread} \div (\text{displacement})^{\frac{2}{3}}$$

SAILING :—		STEAM :—	
Line-of-battle ships	. 100 to 120	Ironclad ships	. . . 60 to 80
		Unarmoured:	
Frigates }	Frigates }
Corvettes }	Corvettes }
Brigs }	Sloops }
	120 to 160		80 to 120

It will be remarked that the proportionate sail power of the steam unarmoured frigates, &c. is, on the whole, less than that of the sailing vessels, and that the armoured ships stand still lower in the scale. But it must be noticed that some of the steam-ships have finer forms and proportions than

* The principal facts contained in this treatise have been republished, with some additions, in *Shipbuilding, Theoretical and Practical*, edited by the late Professor Rankine. The particulars for yachts are taken from Mr. Dixon Kemp's

valuable work on *Yacht Designing*, and from information kindly furnished to the Author by Mr. J. A. Welch, late Superintendent of Cruisers (Coastguard Department), Admiralty.

the sailing ships, so that their resistances may be proportionately less. Further, it is important to note that the great increase in displacement which has accompanied the construction of ironclads renders it practically impossible to give to these heavy vessels a spread of sail comparable in propelling effect to that of the sailing line-of-battle ships, even if other and more important qualities were sacrificed. Take, for example, the 80-gun sailing line-of-battle ship *Vanguard*, with a displacement of 3760 tons and sail spread of 28,100 square feet. Here the quotient sail spread \div (displacement)^{1/3} is not much below 120; in the best of the completed ironclads built for distant services—the *Invincible* class—the corresponding quotient is about 75, and in most of the heavier ironclads it is still less. If the *Hercules*, of over 88,000 tons displacement, were furnished with a sail-power proportioned to that of the 80-gun ship, her total area of plain sail would have to be made nearly 50,000 square feet, the actual area being less than 29,000 square feet. After careful investigation, Mr. Barnaby reported as follows:—

“ It is impossible to obtain so much sail by any multiplication of the number of masts without making them much loftier, unless they were placed so close together as to allow the yards, when braced round, to overlap each other considerably. In this latter case the canvas could scarcely be considered as efficient as in the old ships, and this would involve a further increase upon the area given above.” *

Without attempting any discussion of the actual sailing qualities of the ironclad fleet, we may therefore conclude that the great size of nearly all the rigged ships renders it unreasonable to expect that they could be made as efficient under sail as were the vessels which depended on sail alone for propulsion. Nor does the progress of the ironclad reconstruction at home and abroad tend in this direction; on the contrary, lighter rigs and less sail-power

* See page 342 of the appendix to the report of the Committee on Designs for Ships of War.

have been given to the most recent masted types, and not a few mastless vessels have been constructed.

English yachts of the present day built for racing have ratios of sail spread to the two-thirds power of the displacement varying from 180 to 200; yachts not designed for racing have ratios varying from 130 to 180. In the famous American yacht *Sappho* the ratio reaches 275, but her form differs considerably from that of English yachts, and the mode of comparison is inapplicable. If the ratio of the sail spread to the wetted surfaces be taken, and this is the fairest method, then Mr. Kemp states that for the *Sappho* the ratio is about 2·7 to 1, and for several English racing yachts of large size nearly the same, falling in some examples as low as 2 to 1. It will be remembered that these numbers apply only to plain sail, and do not represent the canvas that can be spread in light winds.

Secondly: it is important to secure a proper *longitudinal distribution* of the sails, in order that neither excessive arduency nor excessive slackness may result, and that sufficient handiness or manœuvring power under sail may be secured. It has already been shown that the difficulties attending any attempt at a general solution of this problem are insuperable; and we are now concerned only with the methods adopted in practice.

The line of action of the resultant wind pressure changes its position greatly under different conditions: the naval architect therefore starts with certain assumed conditions which are seldom or never realised in service, in order to determine the "centre of effort" of the wind on the sails. All the plain sails are supposed to be braced round into the fore-and-aft position, or plane of the masts, and to be perfectly flat-surfaced. The wind is then assumed to blow perpendicularly to the sails, or broadside-on to the ship, and its resultant pressure will obviously act perpendicularly to the sails, through the common centre of gravity of their areas. This common centre of gravity is determined by its vertical

and longitudinal distance from some lines of reference, those usually chosen being the load water-line, and a line drawn perpendicular to it through the middle point of the length of the load-line, measured from the front of the stem to the back of the sternpost. Fig. 126 shows a full-rigged vessel with her sails placed as described; the centre of gravity of the area of plain sail or "centre of effort" being marked C. A specimen calculation, illustrating the simple process by which the point C is determined, is appended.

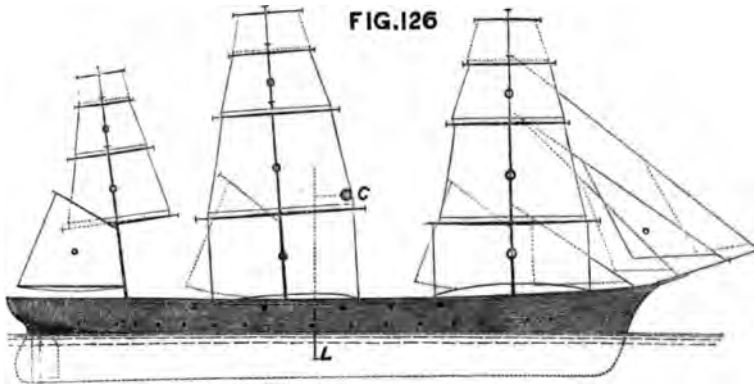
CALCULATION FOR THE CENTRE OF EFFORT OF A SHIP.

Sails.	Areas.	Distances of Centres of Gravity from Middle of Load-line.		Longitudinal Moment of Sails.		Heights of Centres of Gravity above Load-line.	Vertical Moments of Sails.
		Before.	Abaft.	Before.	Abaft.		
Jib	Sq. ft. 1000	Feet. 145	Feet. ..	145,000	..	48	48,000
Fore course	2300	85	..	195,500	..	35	82,800
" topsail	2500	83	..	207,500	..	74	185,000
" top-gallant sail .	1100	82	..	90,200	..	118	118,800
Main course	3000	..	20	..	60,000	35	105,000
" topsail	2500	..	23	..	57,500	76	190,000
" top-gallant sail .	1100	..	25	..	27,500	110	121,000
Driver	1600	..	120	..	192,000	40	64,000
Mizen top-sail . . .	1300	..	100	..	130,000	65	85,800
" top-gallant sail .	600	..	103	..	61,800	92	55,200
Total area of plain sail	17,000			638,200	528,800	17,000	1,055,600
				528,800			
				17,000	109,400		
Centre of effort before middle of load-line				6'43 feet.			
Centre of lateral resistance abaft ditto				6'0 "			
Centre of effort before centre of lateral resistance				12'43 feet.			

When the centre of effort of the sail area has been determined relatively to the middle of the load-line, it is usual also to determine the longitudinal position of another point, commonly styled the "centre of lateral resistance." This is marked L in Fig. 126, and is simply the centre of gravity of the immersed portion of the plane of the masts—the same plane area which was referred to in an earlier part of the chapter as considerably influencing the leeway of a ship sailing on a wind. It will, of course, be understood that the point L is no more supposed to determine the actual

line of action of the resultant resistance than the point C is supposed to determine the line of action of the resultant wind pressure. But, on the other hand, experience proves that the longitudinal distance between the centre of effort C and the centre of lateral resistance L should lie within the limits of certain fractional parts of the length of the load-line.

From the drawings of a ship the position of the centre of lateral resistance may be determined by a very simple calculation; and the particulars required for an approximate calculation are easily obtainable from a ship herself, being



the length at the load-line, draught of water forward and aft, area of rudder, and area of aperture in stern for screw, if the vessel be so constructed.

The distance of the centre of effort before the centre of lateral resistance varies according to the style of rig; and in determining it, regard must be had also to the under-water form of a ship. A full-bowed ship, for example, should have a greater proportionate distance between the two centres than a ship of the same extreme dimensions and draught, but with a finer entrance. In ships trimming considerably by the stern, and with a clean run, the distance between the centres should be made proportionately less. In ship-rigged vessels and barques it appears that the centre of effort is

from one-fourteenth to one-thirtieth of the length before the centre of lateral resistance; one-twentieth being a common value. The greater distance (one-fourteenth) occurred in the old sailing ships of the Royal Navy, with full bows and clean runs; this has been almost equalled in some of the later masted ironclads, where the centre of effort has been placed one-sixteenth of the length before the centre of lateral resistance. The smaller distance occurs in screw frigates of high speed and fine form, such as the *Inconstant*; in the unarmoured screw frigates which preceded them, the distance was from one-twentieth to one-twenty-fourth of the length. In brigs, one-twentieth of the length is a fair average for the distance between the two centres. In schooners and cutters, the two centres are always very close together, their relative positions changing in different examples, and the centre of lateral resistance sometimes lying before the centre of effort. It is to be noted, however, that in a vessel with square sails the longitudinal position of the centre of effort will vary but very slightly, however wide may be the differences between the angles to which the yards are braced. On the contrary, in a schooner or cutter the centre of gravity of the plain sail must move forward with any angle of departure from the hypothetical position in the plane of the masts.

Having decided upon the proper distance between the centre of effort and centre of lateral resistance for a new design, it is next necessary to station the masts and distribute the sail in such a manner that the required position of the centre of effort may be secured, in association with sufficient manœuvring power and a proper balance of sail. In the following table the results of experience with various classes of ships are summarised, all the vessels being supposed capable of proceeding under sail alone.

The length of a ship at the load-line, from the front of the stem to the back of the sternpost, being called 100, the other lengths and distances named will be represented by

the following numbers.* The last two columns in the table will be referred to further on.

Classes of Ships.	Distance from Front of Stem.			Base of Sail.	Height of Centre of Effort above Water = Breadth \times
	Foremast.	Mainmast.	Mizen-mast.		
Ship . . . }	10 to 20	58 to 58	80 to 90	125 to 160	1½ to 2
Barque . . }	17 to 19	64 to 65	..	160 to 165	1½ to 1¾
Brig . . .	16 to 22	55 to 61	..	160 to 170	1½ to 1¾
Schooner	36 to 42	..	170 to 190	1½ to 1¾
Cutter

This table is intentionally confined to the common cases, where the number of masts does not exceed three. Large iron sailing vessels of considerable length and size, and requiring large spreads of canvas, not uncommonly have four masts; the height of the centre of effort being thus kept lower than it could be with an equal sail spread on three masts, and the length of the vessels enabling the sails on each of the four masts to "draw" effectively. In her Majesty's ship *Achilles*, as before stated, the experiment of fitting four masts was tried, but did not succeed. In the *Minotaur* class, five masts are fitted. The *Great Eastern* has six masts, but in her, as in most of the largest ocean-going steamers, the sail-power is of very subordinate importance, being auxiliary to the steam-power, and used only when the wind is fair or in case of accident.

The "rake" given to the masts in different classes of ships requires a few words of explanation. In nearly all cases it is an inclination *aft* from the vertical line drawn through the heel of the mast; but in vessels with "lateen" rig the foremast commonly rakes forward considerably. The following are common values for the rake aft. In cutters, from ½ to

* This table is compiled chiefly from the *Treatise on Masting* by Mr. Fincham, and from *Shipbuilding, Theoretical and Practical*. It also represents the arrangements for some recent types in the Royal

Navy. For other kinds of rig not named above, see the treatise on Masting; for very detailed information as to the rig of French ships of all classes, see *Construction des Bâtimens de Mer*, by M. Viel.

$\frac{1}{3}$ of the length ; in schooners, for foremast, from $\frac{1}{10}$ to $\frac{1}{4}$, and for mainmast, from $\frac{1}{8}$ to $\frac{1}{4}$; in brigs, for foremast, from 0 to $\frac{1}{30}$, for mainmast, from $\frac{1}{8}$ to $\frac{1}{3}$; in ships, for foremast, from 0 to $\frac{1}{36}$, for main and mizen masts, from 0 to $\frac{1}{12}$. It is customary to have the greatest rake in the aftermost mast, and the least in the foremast. Graceful appearance, greater ease and efficiency in supporting the masts by shrouds and rigging, and the possibility of bracing the yards sharper when the masts are raked aft and the rigging led in the usual way, are probably the chief reasons for the common practice. The "steeve" given to the bowsprit is also in great measure a matter of appearance ; and in many ships intended to act as rams, in which the bowsprits are fitted to run-in when required, the steeve is very small. Greater security for the inboard part of the bowsprit, and greater height above water for the outboard part, have also been given as reasons for steaving it, but these are only of secondary importance in very many cases.

It will be observed that the table also gives a length for the "base of sail," in terms of the length of the ship, and this exercises an important influence on manœuvring power of a vessel. In Fig. 126 it would be measured from the foremost corner (or "tack") of the jib to the aftermost corner (or "clew") of the driver; in other classes it would be measured between extreme points corresponding to those named. The base of sail was usually proportionally greater in vessels wholly dependent on sail-power than it is in vessels with steam- and sail-power, the foremast being placed further forward and the mizen-mast further aft than is now common. Special circumstances may, however, limit the length of the base of sail ; and one of the most notable cases in point is to be found in her Majesty's ship *Temeraire*, a *brig-rigged* vessel of over 8400 tons displacement, where the departure from ship rig has been made in order to facilitate the arrangements for the heavy chase guns at the bow and stern.

Experience has also led to the formation of certain rules

for determining the proportionate areas of the sails carried by the different masts, with various styles of rig. According to Mr. Fincham and other authorities, in ship-rigged sailing vessels, if the area of the plain sail on the main mast was called 100, that on the foremast varied from 70 to 77, and on the mizen-mast from 46 to 54. It is now usual in the ships of the Royal Navy to make the corresponding sails on the fore and main masts alike, except the courses; and calling the sail area on the main mast 100, that on the foremast would commonly be from 90 to 95, that on the mizen 45 to 55, and the jib from 15 to 20, the latter agreeing fairly with the practice in sailing vessels. In barque-rigged vessels the sail area on the mizen is often about one-third only of that on the main; the sail area on the foremast having about the same proportion as in ships. In brigs the sail on the foremast varies from 70 to 90 per cent. of that on the mizen; in schooners it is often about 95 per cent.

Another feature somewhat affecting the handiness of a ship under sail, particularly in the earlier movements of any manœuvre, is the distance of the centre of gravity of the ship from the centre of effort. This consideration was formerly treated as of great importance, but it now has little influence in the actual arrangement of sail plans. The longitudinal position of the centre of gravity for the load-draught is usually fixed by other and more important conditions; and its position changes considerably as the amount and stowage of weights on board are varied. It will suffice to say, therefore, that, when the ship is turning, her motion of *rotation* may be regarded as taking place about a vertical axis passing through the centre of gravity; so that the turning effect of any forces will vary with the distance from the centre of gravity of their line of action.* Suppose a ship to have all plain sail set, and balanced so that her

* See, further, Chapter XIV.

course can be kept without using the rudder, the line of action of the resistance will then lie in the same vertical plane with the resultant wind pressure, which may be supposed to pass through the centre of effort. The resistance tends to throw the head of the ship up into the wind in tacking and to assist the helm, but it tends to resist the helm in wearing. The further forward of the centre of gravity the centre of effort is placed, the greater will be the *initial* turning effect of the resistance when a manœuvre begins. But as soon as changes are made in the sails which "draw" in order to assist the manœuvre, and as soon as the action of the rudder is felt, the speed and course of the ship alter, and the initial conditions no longer hold, the line of action of the resistance changing its position from instant to instant.

Lastly: in arranging the sails of a ship, it is necessary to consider their *vertical* distribution, which governs the height of the centre of effort, and the "moment of sail" tending to produce transverse inclination.

The specimen calculation on page 492 shows the ordinary method of estimating the vertical position of the centre of effort when the plain sail is braced fore-and-aft; and no explanation will be needed of this simple calculation. In previous chapters, explanations have been given of the action of the wind on the sails, and of the resulting strains on the rigging and topsides.* It will suffice, therefore, to state that, if the line of action of the wind is assumed to be horizontal, the steady speed of drift to leeward will supply a resistance equal and opposite to the wind pressure, and having a line of action approximately at mid-draught. This couple will incline the ship transversely until an angle of heel is reached for which the moment of stability equals the moment of the inclining couple. Let A = area of plain sail, in square feet; h = the height (in feet) of the centre of

* See pages 62, 136, and 290.

effort above the mid-draught, when the ship is upright; m = the metacentric height (GM) in feet of the ship; D = the displacement (in pounds); p = the pressure, in pounds per square foot, which the assigned velocity of the wind would produce upon a plane placed at right angles to it; and a = the angle of steady heel. Then, within the limits of the angles of steady heel reached in practice, the following equations may be considered to hold:—

$$\text{Moment of sail, to heel ship} = A \times h \times p \cos^2 a;$$

$$\text{Moment of statical stability} = D \times m \times \sin a;$$

whence is obtained the following equation for the angle a ,

$$\sin^2 a + \frac{D m}{A p h} \sin a - 1 = 0.$$

Since a is usually an angle of less than 6 or 8 degrees, this equation may, without any serious error, be written,

$$\frac{D \cdot m}{A \cdot p \cdot h} \sin a = 1; \text{ or } \sin a = \frac{A p h}{D \cdot m}.$$

Suppose, for example, that $p=1$, and that, in the case of Fig. 126, $D=6,800,000$; $m=3$ feet; $A=15,600$; and the mean draught 20 feet. Then $h=62+10=72$ feet;

$$\sin a = \frac{15,600 \times 72}{6,800,000 \times 3} = \frac{468}{8500} = \frac{1}{18} \text{ (nearly),}$$

$$a = 3\frac{1}{4} \text{ degrees (nearly).}$$

It has already been remarked that, for the force of wind when all plain sail would be set, the normal pressure per square foot would be about 1 lb.; and it is very common, in comparing the stiffness of ships, to assume that the pressure p has the value unity.

Looking back to the formula for the angle of steady heel, it will be seen that, if the ratio of $D \cdot m$ to $A \cdot h$ be the same for any two vessels, an equal force of wind p per square foot of area of sail will produce equal angles of heel in both ships.

Hence it has become the practice in the Royal Navy to use this ratio as a measure of the "power of a ship to carry sail." The smaller the ratio, the less is the stiffness of the ship under canvas; the greater the ratio, the stiffer is the ship. Very considerable variations occur in this ratio in different classes. In the *Inconstant*, a vessel designed for high speed under steam as well as for sailing, the number expressing the power to carry sail is as low as 15; in the converted ironclads of the *Prince Consort* class, with metacentric heights twice as great as that of the *Inconstant*, and with a much smaller proportionate spread of canvas, the corresponding number is 51. In some of the earlier ironclads, such as the *Warrior* and *Minotaur* classes, the sail-carrying power is represented by 30 to 35; in the recent ironclads it has been represented by 17 to 25. In the various classes of unarmoured ships very different values occur: from 20 to 25 probably represents the sail-carrying power of the screw frigates of the older type, from 15 to 20 that of the corvettes, and from 10 to 15 that of the smaller classes. Exact information is wanting as to the metacentric heights of the older classes of sailing ships of the Royal Navy, so that no exact estimates can be made of their sail-carrying powers. It appears probable that in the smaller classes the numbers varied between 12 and 20; for the frigates, from 20 to 25; for the line-of-battle ships, from 20 to 30.

The diminution of the metacentric heights in some recent types, in order to secure longer periods of oscillation, which favour greater steadiness, has led to a decreased stiffness as compared with preceding types; this latter feature being indicated by the smaller numbers of the sail-carrying power. In other words, greater angles of steady heel under canvas are now common than were formerly customary. It was important when ships had to fight under sail that the angle of heel should not be excessive, and 5 or 6 degrees was the limit named by writers on the subject; in steam-ships there is no equally powerful reason for securing equal stiffness, steadiness being the chief desideratum, and angles of

heel under plain sail of 8 or 10 degrees sometimes occur.*

It is estimated by Mr. Dixon Kemp that some of the most successful English yachts would be steadily heeled to angles of 7 to 14 degrees, under plain sail, by a wind pressure of 1 lb. per square foot; this would indicate that their "power to carry sail" varied from 4 to 8. Further it is stated that in match-sailing steady angles of heel of 20 or 30 degrees are not uncommon; but there is little or no risk of such vessels being capsized, as their ballast brings the centre of gravity very low in the vessel, and gives them an extraordinary range of stability.†

The practice in the days of sailing ships was to proportion the heights of the masts and the depths of the sails to the breadth extreme of the ships; and hence it was usual to express the height of the centre of effort above the load-line in terms of the breadth. The right-hand column in the table on page 495 contains the average multipliers by which the breadth extreme in various classes of ships should be affected, in order that the height of the centre of effort above the load-line may be approximately found. Such an approximation is not, of course, intended to take the place of an exact calculation for the position of the centre of effort; but it may be of some service. It will be noticed that to the height so found must be added the half-draught, in order that the moment of the sail may be calculated.

Generally, if there be no similar vessel to compare with the new design, the problem of the vertical distribution of

* See page 225 of Mr. Childers' minute on the loss of the *Captain*. The day before the disaster, during a trial of sailing, when the stiff ships *Lord Warden*, *Minotaur*, *Agincourt*, *Northumberland*, and *Warrior* were heeling from 3 to 5 degrees, the *Hercules* heeled 6 degrees,

the *Monarch* 7 degrees, the *Bellerophon* and *Captain* 9 degrees, and the *Inconstant* 11 degrees.

† See the curves published in *Yacht Designing*; showing ranges of stability approaching 180 degrees.

the sail takes the form of a determination of the height h of the centre of effort above the centre of lateral resistance. In that case the whole of the quantities in the formula given above, except the height h , may be supposed known, the maximum angle of steady heel α being assigned for a pressure of 1 lb. per square foot of canvas. Hence

$$h = \frac{D m}{A} \cdot \sin \alpha,$$

very nearly, when α does not exceed the usual limits.

There are also practical rules by which the ratios of the areas of the different sails, the lengths of the masts and yards, and other features of a plan of sails are governed; but for these we are unable to find space, and they can be consulted by those readers desiring information, in the standard works mentioned above.

In conclusion, brief reference must be made to the changes introduced of late years into the proportions of length to breadth in sailing ships. It was formerly assumed that the length of a successful sailing ship should not exceed four times the beam; in many vessels having a high reputation for performance and speed, the length was not much more than three times the beam. The great increase in the proportionate lengths of steam-ships and the consequent improvement in their performance appears to have affected the construction of sailing ships; the clippers of the mercantile marine frequently have lengths from five to six times the beam. There can, of course, now be no question as to the diminution of the resistance by the increase in the ratio of length to breadth, and greater fineness of form. In these clippers the requisite stiffness appears to have been secured with the use of very little ballast, by associating appropriate fineness of the under-water form with the greater length.

The passages made by some of these clipper ships are notable even in the days when steam navigation is being

successfully introduced for the longest voyages.* On the China trade, until the Suez Canal was opened, the clippers competed successfully with steamers, occupying from 90 to 100 days as against 75 to 80 days for the steamers. On the Australian service also the clippers have done equally well. The *Thermopylæ*, for example, made the passage from London to Melbourne in 60 days: a time only one-third longer than that taken by the best steamers now employed on that service.

We have been favoured by the designer of this remarkably successful vessel, Mr. Waymouth, Secretary to Lloyd's Register, with the following particulars of her design; which will enable a comparison to be made between the modern sailing ship and one of the most successful sailing frigates of the Royal Navy, her Majesty's ship *Pique*.

Particulars.	<i>Thermopylæ.</i>	<i>Pique.</i>
Length	210 feet	162 feet
Breadth	36 "	48½ "
Displacement	1,970 tons	1,912 tons
Area of plain sail	17,520 sq. ft.	19,086 sq. ft.
Area of plain sail ÷ (displacement) ²	110	124

The sail spread of the *Thermopylæ* is, therefore, less proportionally than that of the *Pique*; but her greater length and fineness of form probably cause a considerable diminution in resistance, and give to the *Thermopylæ* greater speed in making passages than the sailing frigate possessed.

Another clipper, also designed by Mr. Waymouth, has made no less remarkable passages, viz. the *Melbourne*, owned by Messrs. Green, and employed on the Australian service. Last year (1876) this vessel made the passage from England to Melbourne in 74 days; experiencing far from favourable conditions during part of the voyage. From the Cape, how-

* For a mass of interesting information on the subject, see the article on "Clipper Ships" in *Naval Science* for 1873.

ever, fine fair winds were obtained, and for seventeen consecutive days 300 miles a day were averaged. The three longest runs in this time were 374, 365, and 352 miles per day. This vessel is about 3500 tons displacement, and her area of plain sail is rather less than 21,000 square feet; the ratio sail spread to the two-thirds power of the displacement being about 90 to 1, or about the same as in the wooden screw frigates of the Royal Navy.

Another example of high speed under sail being obtained in vessels which have good proportions of length to beam and fine form is found in the *Inconstant*, of the Royal Navy, which has made runs at speeds of from $13\frac{1}{2}$ to $14\frac{1}{2}$ knots per hour under sail alone.

The smaller proportions of length to breadth adopted in the old sailing ships of war were probably chosen because these vessels were required to be pre-eminently handy under sail, in order to be efficient in action. In this respect the modern merchantman could scarcely compare with the earlier class; the performance of their voyages does not necessitate the possession of similar quickness in manœuvring. Moreover, the sailing ships of war had to be loftier than the merchantman, to carry considerable weights of armament, &c. on the decks instead of cargo in the hold, and yet to be stiff under canvas, so that no great heel should be produced when going into action. In short, as with steam-ships of the present day, so with the sailing ships of the past: vessels of war had to be designed to fulfil conditions which permitted far less latitude in the choice of forms and proportions than is possible in the designs of merchant ships. The large number of sailing ships still employed in the mercantile marines of this and other countries makes it desirable, however, to notice any change which promotes their efficiency; and undoubtedly one such change is to be found in the increased lengths and fineness of form adopted in recent ships.

It is interesting to note that, in yachts designed for racing, the proportions of length to beam are commonly

between 4 to 1 and 5 to 1, the upper limit being reached in comparatively few cases. The general selection of these proportions is good evidence that they are well adapted for the class ; in which handiness and weatherliness are no less important than speed with the wind abaft the beam. There are, however, several cases on record in which these vessels have attained speeds of 13 or 14 knots per hour ; and the American yacht *Sappho* is said to have made 16 knots per hour, for several consecutive hours, during her passage across the Atlantic.

CHAPTER XIII.

STEAM PROPULSION.

FORTY years ago the employment of steam-ships in ocean navigation was a matter of warm debate. Steamers had been successfully employed on rivers, lakes, and inland waters, as well as on coastwise services and short sea passages. But it was urged that long voyages must still be performed by sailing ships, either because steamers could not carry coal sufficient to propel themselves over long distances or because the expenditure on the propelling power would be so great as to render remunerative service impossible. The Transatlantic service, with its voyage of 3000 miles, was more especially kept in view in these discussions; and when the *Great Western* and *Sirius* made successful passages from England to New York in 1838, the arguments against the capabilities of steam-ships for sea-going services, in competition with sailing ships, were practically destroyed. From that time onwards steam navigation has been continuously and rapidly developed. The sizes and speeds of individual ships have been gradually increased, and their capacities for performing long voyages made greater. For many years sailing ships remained in sole possession of the China and Australian trade; but the opening of the Suez Canal, and the consequent saving on the length of voyage from England to China, have led to the extensive use of steamers on that route; while the progress made in steamship construction has enabled the longest ocean voyage that requires to be performed, from England to Australia, to be successfully accomplished by steamers.

This crowning triumph of steam navigation deserves especial mention. Ships are now running on the Australian line which perform a voyage exceeding 12,000 nautical miles at an average speed of 11 or 12 knots, and consume only 1500 or 1600 tons of coal to drive a weight of 6000 to 7000 tons from port to port. Placing these facts beside the corresponding figures for the *Great Western*, a successful ship in her day, one is enabled to appreciate better the progress of forty years. That vessel had an average ocean speed of 8 or 9 knots, and consumed from 400 to 500 tons of coal in driving a weight of about 2000 tons a distance of 3000 miles. Contrasting the pioneer Atlantic steamer with the magnificent vessels now employed, no less remarkable evidence of progress will appear. Existing vessels are four times as heavy as the *Great Western*, but can make the passage, at an average speed of 14 to 15½ knots, with an expenditure of coal only twice as great as that of their predecessor.

In the construction of steam-ships of war, similar progress has been made; but the period over which it has extended is less by ten or twelve years than the corresponding period in the mercantile marine. So late as 1846 experimental squadrons of sailing ships belonging to the Royal Navy were attracting the greatest attention of all persons interested in naval affairs; and the steam reconstruction of the Navy was not fairly begun until several years after. Into the causes of this delay it is now unnecessary to enter; but it is important to note the great advances which have been made during the last twenty years. The earliest screw line-of-battle ships had speeds of about 9 or 10 knots; the latest and fastest vessels of that class did not exceed 13 knots. The armoured battle-ships now afloat have speeds of 14 or 15 knots, and are twice or thrice as heavy as their predecessors. The earlier types of unarmoured frigates and corvettes attained speeds of 10 to 13 knots; existing types of frigates and corvettes have speeds ranging from 13 to 16 knots. Hereafter it will be shown how great is the proportionate

expenditure of power required to attain these higher speeds, but the mere statement of the facts will suffice to illustrate the contrast between the steaming capabilities of war-ships of the present day and those of twenty years ago.

It would be beside our present purpose to attempt even a sketch of the history of steam navigation, either for the mercantile marine or the Royal Navy; although the interest and importance of the subject cannot well be exaggerated. In this chapter we propose simply to treat of steam propulsion as it affects the work of the naval architect; and although references will necessarily be made to the work of the marine engineer, no descriptions will be given of the various types of engines and boilers in common use, nor of the many ingenious devices by which it is sought to obtain increased power and efficiency with a certain weight of propelling apparatus. Even when thus restricted, the field of inquiry that remains open is very large, and deserving of the most careful study. It includes a consideration of all the circumstances which the designer of a steamer has to take into account when determining the form, dimensions, and engine-power required to attain a certain assigned speed. An exhaustive discussion of these subjects is impossible without recourse to mathematical investigations such as cannot be introduced into this work; but it will be possible to indicate in general terms the principal deductions from such investigations, and to illustrate the principles by which the development of steam propulsion has been guided.

The problem of steam-ship design is not one admitting of any general solution; because the conditions to be fulfilled, in association with the attainment of certain speeds, vary greatly in different classes of ships. These conditions commonly include a certain minimum carrying power; limitations in the draught of water, dependent upon the service in which the vessel is to be employed; limits of length, or in the ratio of length to breadth and depth; and the capability of steaming certain distances without requiring

to take more coal on board ; besides others that need not be mentioned. In order to fulfil all these requirements and to secure the assigned speed, joint action is necessary on the part of the naval architect and marine engineer. Upon the latter devolve the actual design and construction of the propelling apparatus ; and his skill is displayed in providing machinery which shall be compact, durable, strong, as light as possible in proportion to the power developed, and economical in the consumption of fuel. The requirements of the engineer also exercise considerable influence upon the internal arrangements, particularly in the appropriation of the spaces for the machinery, the efficient ventilation of those spaces, and the structural arrangements necessary to resist the local strains incidental to propulsion. Furnished with the opinion of the engineer on all these matters, and with data as to the ratio which the weight of the machinery will bear to its power, the naval architect proceeds to approximate to the form and dimensions most suitable for the new ship.

This approximation is necessarily made tentatively. In the earlier stages, the engine-power must be expressed in terms of the assigned speed, and of a displacement which is itself unknown. Upon the power of the engines must depend their weight, and the weight of coal to be carried for a voyage of given length. And, further, the weight of hull, as well as the weights of certain parts of the equipment, must vary with the total weight of the ship, her extreme dimensions, type, and structural arrangements. Apart from experience, a problem involving so many unknown quantities could scarcely be solved ; but, guided by the results obtained in actual ships, the designer can proceed with a considerable degree of confidence. For example, he may express the weight of hull, &c. as a fraction of the displacement ; and if the new ship is not very dissimilar from existing types, of which the performances under steam have been recorded, it is also possible to determine, in terms of the displacement, the power and weight of the machinery, as well as the appro-

priate coal supply. The remaining part of the displacement will consist of the weights to be carried; these are given quantities, and hence an equation may be formed from which the displacement may be estimated with a close approach to accuracy.

The case is more difficult when the new design is to be of novel form or unprecedented speed; and, apart from model experiments such as were described in Chapter XI. page 463, considerable doubt may surround the approximation to the dimensions and displacement. With such experiments, however, it is possible to compare the resistances of alternative forms; to select that which best fulfils the essential conditions, in association with the least proportionate resistance; and afterwards to express the engine-power required to propel the ship at the desired speed, in terms of the product of that speed into the corresponding resistance.

The "useful work" performed by the engines of a steamer moving at a certain speed, is measured by the product of the resistance corresponding to that speed into the distance through which that resistance is overcome in a unit of time.* It will be remembered that the term *resistance* has been applied to the strain which would be brought upon a tow-rope if the ship were drawn along by some external force which did not interfere with the free flow of water past her hull. Suppose the resistance (R) to be expressed in pounds, and the speed (S) in feet per second; then the

$$\text{Useful work (per second)} = R \cdot S \text{ (units of work).}$$

One "horse-power" represents 33,000 units of work per minute, or 550 units per second; hence for the horse-power corresponding to the useful work, or "effective horse-power," as it is termed, we have

$$\text{Effective horse-power (E.H.P.)} = \frac{R \cdot S}{550}.$$

For example, in the *Greyhound* experiments it was found

* See the remarks on "Work" at page 131.

that the resistance at a speed of 16.95 feet per second, equalled 10,770 lbs.

$$\text{Effective horse-power} = \frac{10,770 \times 16.95}{550} = 332.$$

This effective horse-power differs considerably from the actual horse-power developed by the engines; but before endeavouring to explain the causes which influence the ratio which the useful work bears to the total work of the engines, it may be well to describe how the latter is usually expressed, in order to assist readers unfamiliar with the subject.

The power of marine engines is expressed either in "nominal" or "indicated" horse-power. Indicated horse-power measures the work done by the steam in the cylinders during a unit of time. If the effective mean pressure of the steam upon the pistons is p lbs. per square inch of the total piston area (A square inches); if l be the length of the "stroke" of the pistons (in feet), and n the number of strokes made per minute: then the total mean pressure on the pistons will be pA lbs., and the distance through which it acts (or speed of piston) will be nl feet per minute. The work performed per minute is therefore given by the expression,

$$\text{Work} = p \cdot A \times n l \text{ (units),}$$

and this is equivalent to

$$\text{Indicated horse-power (I.H.P.)} = \frac{p \cdot A \times n l}{33,000}.$$

The effective mean pressure of the steam is ascertained from diagrams, drawn by means of the useful little instrument known as the "indicator;" and hence the term "indicated horse-power" is derived.* It will thus be seen to have a definite meaning, although it is by no means a complete representation of the efficiency of the propelling

* For details of this instrument and its mode of application, the reader must refer to works on the steam-engine, wherein will also be found information respecting the very various pressures of steam, and speeds of piston, used in different types of engines.

apparatus. It takes no account of the efficiency of the boilers as steam generators, or of the rate of coal consumption, or of other important matters; but notwithstanding these omissions, the naval architect most fairly expresses the power required to drive a ship by the indicated power of her engines. The same measure will be employed in the estimates which appear in the subsequent parts of this chapter, except where the contrary is expressly stated.

“Nominal” horse-power was formerly the sole measure which appeared in the Navy List for her Majesty’s ships; it is still the only measure appearing in the Mercantile Navy List, and is still used in the French and American navies. Simultaneously with the introduction of displacement tonnage, instead of the B.O.M. for the ships of the Royal Navy, indicated horse-power was introduced into the Navy List; it alone appears for ships of recent design, but for vessels of earlier date both the nominal and indicated powers appear. The following examples will show how greatly different in different ships might be the ratio of the nominal power to the actual or indicated power of the engines.

Ships.	Horse-power.		Ratio of I.H.P. to N.H.P.
	Indicated.	Nominal.	
<i>Albacore</i> . . .	109	60	1·82
<i>Spiteful</i> . . .	796	280	2·85
<i>Supply</i> . . .	265	80	3·31
<i>Stmoom</i> . . .	1576	400	3·94
<i>Hector</i> . . .	3256	800	4·07
<i>Agincourt</i> . . .	6867	1350	5·08
<i>Bellerophon</i> . . .	6521	1000	6·52
<i>Monarch</i> . . .	7842	1100	7·13
<i>Penelope</i> . . .	4703	600	7·84

The cause of these differences is to be found in the rules by which the nominal horse-power was calculated. For all ships, instead of the true mean pressure of the steam on the

pistons, a fictitious pressure of 7 lbs. per square inch was assumed. In screw steamers, the *intended* piston speed (say in feet per minute) was taken as the true speed, and

$$\left. \begin{array}{l} \text{Nominal} \\ \text{horse-power} \end{array} \right\} = \frac{7 \times \text{area of pistons} \times \text{intended speed of piston}^{\text{lbs.}}}{33,000}$$

In paddle steamers not even the intended piston speed was regarded, but a fictitious speed was assumed, according to a law which has been thus stated—

$$\left. \begin{array}{l} \text{Assumed speed of piston (feet} \\ \text{per minute)} \end{array} \right\} = 129.7 (\text{length of stroke})^{\frac{1}{3.75}}$$

and for these vessels

$$\text{Nominal horse-power} = \frac{7 \times \text{area of pistons} \times \text{assumed speed}^{\text{lbs.}}}{33,000}$$

The manufacturer of the engines was usually under no obligation to conform to the assumed speeds of piston, and often exceeded them; while the assumed mean pressure was much below the effective mean pressure; two facts which explain the very different ratios of nominal to indicated horse-power which existed in different vessels. The change from nominal to indicated horse-power for the ships of the Royal Navy has so generally commended itself that further remarks are needless.

In the French navy the nominal horse-power is *one-fourth* of the power which it is expected the engines will develop; and in a large number of cases the actual indicated power is found to lie between 4 and 4½ times the nominal power. A French "horse-power" (*cheval vapeur*) is rather less than the English, being 32,549 foot-pounds per minute, instead of 33,000. To convert French into English measures, the former must be multiplied by 0.9863.

Nominal horse-power for the British mercantile marine is not defined by law. Formerly the rule established by the

practice of Messrs. Boulton and Watt was generally employed; it was very similar to the old Admiralty rule for paddle steamers, the same effective pressure of 7 lbs. per square inch of piston area being assumed; but the

Assumed speed of piston = $128 \sqrt[3]{\text{Length of stroke.}}$

This rule has not yet fallen into disuse, but is sometimes stated as follows:—Let D^2 = sum of squares of diameters of cylinders (in inches); then—

Nominal horse-power $\left\{ = \frac{1}{47} \times D^2 \times \sqrt[3]{\text{length of stroke.}}$

The commercial nominal horse-power is, however, very frequently represented by the following expression—

1 nominal horse-power = 30 circular inches of piston area.

A “circular inch” being a circle of 1 inch diameter, the total nominal horse-power of a set of engines would be obtained by finding the number of circular inches in all the piston areas, and dividing by 30. This rule corresponds with that of Messrs. Boulton and Watt, when the piston speed is assumed to be 200 feet per minute.

Various proposals have been made with a view to improving the commercial method of measuring horse-power, but none of them has found general favour.* In 1872, the council of the Institution of Naval Architects, having been consulted on the subject by the Board of Trade, replied as follows:—“The term nominal horse-power as at present “ordinarily used for commercial purposes conveys no definite “meaning.” . . . “The majority of the committee were of “opinion that no formula depending upon the dimensions of “any parts of the engines, boilers, or furnaces could be relied

* Mr. McFarlane Gray, of the Board of Trade, proposed a method of measuring nominal horse-power, which was referred to the council of the Institution of Naval Archi-

itects in 1872, but not approved by them. It was based on two measurements, diameter of cylinders and width of furnace.

“upon as giving a satisfactory measure of the power of an engine; and that even if the varieties of engines and boilers now in use could be comprised under one general expression for the power, the progress of invention would soon vitiate any such expression or formula.” The committee could not agree to any alternative mode of measuring engine-power, but the plan which met with least objection was to take either the indicated power on a trial trip as the nominal power, or some sub-multiple, such as *one-fourth* of the indicated power; the latter would be very nearly the same as the French rule. So far as we are informed, no action has yet been taken to give effect to the recommendations, and to assign a uniform or definite meaning to a nominal horse-power in the mercantile marine.

In selecting the type of engine to be employed in a new ship, in consultation with the marine engineer, the designer has to consider the ratio of the weight of the various types to their indicated horse-power, and their relative coal consumption. It is usual to express the weight of machinery in “hundredweights per indicated horse-power” and the coal consumed in “pounds per indicated horse-power per hour.” Both these quantities may be affected by the special conditions to be fulfilled in various ships, especially in warships, even for any single type of engine; but the following brief statement may be of service, representing, as it does, the average results of good practice in the Royal Navy. Three types of engines are now in common use: first, the ordinary type, with jet condensers, such as is fitted in the *Warrior* and other early ironclads; second, the surface-condenser type, such as is fitted in the *Hercules*, *Devastation*, and other ironclads built in 1863–71; third, the compound type, that has been extensively adopted during the last few years, and was recommended strongly by the Committee on Designs for Ships of War in their report of 1871. Besides these three types of engines, there are others respecting which nothing need be said.

For the three types named, the average weights and rates

of coal consumption at full speed are approximately as follows :—

Types of Engines.	Weight per Indicated Horse-power.	Rate of Coal Consumption per Indicated Horse-power per Hour.
Warrior type . . .	3½ cwt.	4 to 6 lbs.
Devastation type . . .	3 "	3 to 4 "
Compound	3½ "	2 to 3 "

In the mercantile marine, the compound engine has been extensively used for many years past with the greatest advantage as regards economy of fuel and efficient performance.* It appears, however, that, while the rate of consumption of coal is about 2 lbs. per indicated horse-power per hour when these vessels are making long passages at full speed, the weight of the machinery in proportion to the indicated horse-power is somewhat greater than in the engines of similar type used in the Royal Navy. On the other hand, marine engines have been constructed for special services, with weights not exceeding 2 cwt. per indicated horse-power; and still more in contrast with the general practice is that followed by the builders of the fast steam-launches, in which the weight of the whole propelling apparatus, in full working order, has been brought to about ½ cwt. per indicated horse-power. The remarkable performances of these small vessels will be further examined hereafter; but it is a question for the marine engineer whether, on the large scale, any similar economy of weight may not be practicable.

A simple example will illustrate the advantages gained by adopting a type of engine which economises fuel, even if the engine itself has to be made somewhat heavier. Her Majesty's ship *Devastation* has engines of the surface-condensing type, which indicated on trial more than 6600 horse-

* See the appendix to the report of the Committee on Designs for Ships of War, for the records of experience of several eminent marine engineers.

power, and drove the ship 13·8 knots per hour. These engines weigh 1000 tons, and the total coal supply carried at the normal draught is 1350 tons. Had the engines been made on the compound type, they would have weighed about 1250 tons, or 250 tons more than their actual weight; but the rate of coal consumption would have been only two-thirds as great as that of the present engines, and therefore, with 900 tons of coal, the vessel would have been able to steam as far as she now can with 1350 tons. This saving on the coals would not only cover the additional weight of the engines, but enable either 200 tons to be added to the weight of armour, armament, and equipment, or the distances over which the ship could steam to be increased about one-fifth, or any corresponding change to be made that might be preferred.

In the case of a merchant steamer making frequent passages over a known distance, savings in coal consumption are even more important. One of the large Transatlantic steamers, for instance, now burning 800 tons of coal on the voyage, would, with engines of the old jet-condenser type, have to burn 1800 or 2000 tons, and, with the surface-condenser type of engine, would burn about 1200 or 1400 tons. On the work of a year the savings effected by using the most economical type would be very considerable.

The longer the voyage and the larger the proportionate coal supply, the greater are the gains of the modern type. For example, a steamer which now has to carry a weight of coal equalling *three-tenths* of her total displacement, in order to perform the voyage to Australia, might have nearly *one-fourth* of the displacement available for cargo. But if she had engines of the early type, consuming coal twice as rapidly, she would require to carry coals amounting to *three-fifths* of her total weight, and could carry no cargo. If she had engines of the surface-condensing type, the coal supply would have to be increased to nearly *one-half* the displacement; and after allowing for the small saving on the weight of engines, as compared with the compound type, the weight of cargo that could be carried would be very small—not one-

half that which the modern ship would carry. These are not mere estimates, but simple statements of fact based upon the particulars of ships now employed upon the service. And it is to the improvements in marine engines, which have brought about such great economy in consumption of fuel, that the moderate size of these successful ships is due. When the design of the *Great Eastern* was in contemplation, no such results had been attained, and it appeared necessary to build a ship of extraordinary dimensions, for a service which is now successfully accomplished by ships of less than one-fourth her displacement.

Adopting the indicated horse-power as the fairest measure of the power of engines, it is important to ascertain the ratio which the indicated power bears to the "effective horse-power" previously defined. This ratio will mainly depend upon three circumstances: (1) the efficiency of the mechanism of the engines; (2) the efficiency of the propeller; (3) the increased resistance, due to the changes produced by the action of the propeller in the motion of the water relatively to the hull of the ship.

When an engine is in motion under its load, a considerable part of its indicated power must be expended in overcoming frictional and other resistances, working the air-pumps, &c.; and only the remaining part of the power is available to give motion to the propeller. The proportion of the indicated power expended in this "waste work" no doubt varies in different engines, and in any engine when working at different speeds. General experience appears to have shown that one-fourth or one-fifth of the indicated power would be a fair average allowance for the waste work of engines working at full speed; these are the figures given by Professor Rankine and other authorities. The best and most recent information of the kind yet published is, however, due to the researches of Mr. Froude.* Having analysed

* See his paper "On the Ratio of Indicated to Effective Horse-power," vol. xvii. of the *Transactions* of the Institution of Naval Architects.

the steam trials of many ships, Mr. Froude is of opinion that, in the engines of screw-steamers, working at full speed, the waste work is quite three-tenths of the indicated power; only about seven-tenths being available for giving motion to the propeller. At lower speeds the waste work is proportionately greater, and in some cases, for very low speeds, it is considered to rise as high as one-half the indicated power. The ratio of the available power to the total indicated power—from 70 to 80 per cent. for full speed—expresses the *efficiency* of the mechanism. It does not appear that in this particular marine engines compare badly with land engines; but the analyses which Mr. Froude has published must suggest the desirability of careful consideration and possibly improved arrangements, by which the waste work of the machinery may be diminished, and its efficiency increased.

It will be convenient to consider together the efficiency of the propellers in common use, and their influence upon the motion of the water passing a ship. The screw, the paddle, and the water-jet are the only propellers that need be mentioned, no others having claims to serious consideration. The paddle has been in use from the earliest days of steam propulsion, the screw for about forty years, and the water jet was first employed so long ago as 1843. The last-mentioned propeller can scarcely be regarded as having passed beyond the stage of experiment, having been adopted in several small vessels and floating fire-engines, but only in one ship of moderate size, her Majesty's ship *Waterwitch*. It has, however, attracted so much attention, and been so strongly recommended, that it cannot be left unnoticed. The paddle-wheel was the first propeller employed, and although it has now given place to the screw for ocean navigation, it still remains in common use for river and shallow-water steamers. The screw is now by far the most important propelling instrument, and there seems no present probability of any other propeller replacing it; so that it claims most attention. It is proposed to glance at the distinctive features of the other two propellers before passing

to the consideration of the screw; and in order to compare their relative efficiency, it may be well to state briefly the fundamental principle of the action of all propellers.

The action of the propeller drives sternwards a stream of water, and the reaction of that stream drives the ship ahead. This reaction is measured by the sternward *momentum* communicated to the stream in a unit of time, and may be expressed as follows:—Let C = the cubic feet of water acted upon by the propeller per second: for sea-water weighing 64 lbs. per cubic foot, the weight of water acted upon per second must be $64C$ lbs. Let v = the sternward velocity (in feet per second) impressed upon the stream: then the magnitude of the force of reaction R is measured by the added velocity (as explained on page 152), and we must have—

$$\frac{\text{Reaction (R)}}{\text{Weight of water acted upon}} = \frac{v}{g} = \frac{v}{32.2} ;$$

$$\begin{aligned} R &= \frac{v}{32.2} \times \text{weight of water acted upon} \\ &= \frac{v}{32.2} \times 64C \text{ lbs.} = 2Cv \text{ lbs. (nearly).} \end{aligned}$$

This reaction measures the propelling force, or thrust of the propeller. When the ship is in uniform motion, there must be an exact balance between this thrust and the total resistance then opposing the motion of the ship. When the thrust exceeds the resistance, the motion of the ship will be accelerated; when the converse happens, the motion will be retarded. It is, however, important to note the fact mentioned above, viz. that, when a propeller acts upon the streams of water flowing past a ship, their natural flow (described in Chapter XI.) is interfered with more or less; the result being an increase in the resistance experienced by the ship. This point will be further elucidated.

From the foregoing general expression it appears that the thrust of a propeller depends upon the *quantity of water*

acted upon per second, and the *sternward velocity* impressed. So long as the product Cv is unaltered, so long does the thrust remain constant, no matter how C and v may be individually varied. It may be noted, however, that in practice it is always preferable to make the value of the velocity v as small as possible, in order to reduce the waste work performed in giving motion to the race, and to lessen the speed at which the propeller has to be driven; so that it is advantageous to adopt a form of propeller which will operate upon the largest possible quantities of water. Moreover, all conditions which affect the flow of water to the propeller must exercise a sensible effect upon its efficiency. And, lastly, the position in relation to the ship in which a propeller is placed may greatly affect its efficiency, more especially through its influence upon the stream-line motions, and the effect of those motions upon the supply of water to the propeller.*

The water-jet is the simplest of the three propellers. In her Majesty's ship *Waterwitch* it is applied in the following manner. Openings are made in the bottom of the ship to permit the passage of water into the interior. The water which enters necessarily has the forward motion of the ship impressed upon it, then passes into a turbine driven by the main engines, and is expelled, with considerable velocity, through passages leading to an outlet or nozzle placed on each side, at the level of the load-line. These nozzles direct the issuing streams sternward when the ship is to be moved ahead, and in the opposite direction when she is to go astern; arrangements being made by which the

* Readers desirous of following out the mathematical treatment of this subject may consult with advantage the paper "On the Mechanical Principles of the Action of Propellers," contributed to vol. vi. of the *Transactions* of the Institution

of Naval Architects, by the late Professor Rankine; as well as the remarks of Mr. Froude on that paper; also the papers by Professor Cotterill published in Nos. 2 and 3 of the *Annual* of the Royal School of Naval Architecture.

direction of outflow can be easily reversed. The sternward velocity with which the issuing streams are impressed is, of course, the difference between their actual velocity of outflow (V) through the nozzles and the speed of advance (v) of the ship. If A = the joint area of the outlets in square feet, we have—

Cubic feet of water acted upon per second = ΔV ;

Sternward velocity (in relation to still water) = $V - v$;

Thrust: or momentum created
per second in sea water . . . } = $2AV(V - v)$ lbs. (nearly).

It is important to note that the propelling effect due to the reaction of the streams issuing from the nozzles is as great when the outlets are placed above water as when they are under water, if the velocity of outflow and the speed of the ship are the same. If the nozzles are placed above water, the turbine has to do some small amount of additional work, in raising the water-jets to the height of the nozzles before expelling them. If the nozzles are placed under water, their projection beyond the sides of the ship will cause additional resistance, especially if they are of large sectional area. In the *Waterwitch*, as stated above, the nozzles are placed at the level of the load-line.

The following points require careful consideration in making use of the water-jet propeller, if its efficiency is to be made as great as possible:—First: the arrangement of the inlets in the bottom; otherwise waste work may be done in giving motion to masses of water which do not enter the ship. Second: the arrangement of the pipes and channels by which the jets are conducted from the inlets to the outlets; otherwise the frictional and other resistances of the water in passing through these channels may become unnecessarily great. Third: the determination of the sectional areas of the outlets, their positions, and the forms of their casings; otherwise the sectional areas of the jets may be too small to secure economical propulsion, or the passage of the casings through the water may give rise to serious resist-

ance. Besides these matters, there are the equally important questions relating to the design of the engines which drive the turbine, and of the turbine itself; but these concern the marine engineer.

Usually the inlets and outlets of a vessel propelled in this manner are placed amidships, where the streams produced by the passage of the ship in the surrounding water have their maximum sternward motion relatively to her.* This fact may somewhat reduce the efficiency of the propeller, as compared with what its action would be if the water were undisturbed by the passage of the ship. A far more serious decrease of efficiency results from the resistances to be overcome in driving the water through the curved passages from the turbine to the nozzles; and these resistances must increase rapidly with the speed with which the water is driven. Theoretically the larger the sectional area (A) of the nozzles becomes, in order to make (V) the velocity of outflow as small as possible, for a certain propelling force and a certain speed of ship, the greater should be the efficiency of the propeller. But in practice there are various limitations to any increase in the area of outlets approaching the dimensions which theory would assign; and this fact, together with the resistances to be overcome in the passages, makes the jet-propeller compare unfavourably with the screw and paddle.

In the case of the *Waterwitch* the joint sectional areas of the nozzles amounted to $5\frac{1}{2}$ square feet only, these being the sectional areas of the streams to which the propeller gives sternward velocity. On investigation it appears that the quantity of water passing through the nozzles per second when the vessel attained a speed of 9.3 knots was only about 150 cubic feet, the velocity of outflow being less than 30 feet per second. The smallness of this quantity will appear more clearly if it is compared with the quantity of water acted upon by the twin-screws of the *Viper*, when tried

* See page 434.

in competition with the *Waterwitch*. The *Viper* attained a speed of 9.6 knots, her engines developed 696 horse-power, her displacement being 1180 tons, and her twin-screws operated on over 2000 cubic feet of water per second, quite fourteen times as large a quantity as the jets of the *Waterwitch* delivered per second. It is not surprising, therefore, that the latter ship attained no higher speed than 9.3 knots with 760 indicated horse-power, although her displacement was only 1160 tons, and her form at the stern was so much finer than that of the *Viper* as to considerably decrease the resistance. It is unnecessary to give a similar comparison with a paddle-wheel vessel, or to say more at present respecting the contrast between the screw and jet, because in discussing the efficiency of screw propellers many matters now unnoticed will be mentioned.

Experiments have been made with the *Waterwitch* to test the effect of *reducing* the sectional areas of the nozzles, and the results obtained indicate some decrease of efficiency as compared with the performances with full-sized nozzles, just as might be expected from the general considerations stated above. No experiments have been made with nozzles enlarged beyond the sectional area of $5\frac{1}{2}$ square feet, which has been shown to be proportionately very small. Considerable changes would have been required in the ship before this enlargement of the nozzles could be effected; but there is every reason to believe that in any future jet-propelled ship it would be found advantageous to adopt nozzles of greater size, and to reduce the velocity of outflow of the jets.

It has been urged that the increased manœuvring power obtained with jet-propellers should lead to their adoption in vessels of war, even though they are less efficient for propulsion than the screw or paddle. This point will be discussed in Chapter XIV.; it will only be necessary to add here that this kind of propeller is especially well adapted for vessels designed as floating tire-engines, where the pumping power, which has to be provided independently

of propulsion, can be readily made available for giving motion to the vessels.

Paddle-wheels, like jet-propellers, give direct sternward momentum to streams of water, the reaction of which constitutes the thrust or propelling force. These streams form what is termed the "paddle-race"; and their cross-sectional areas depend upon the area and immersion of the paddle-floats. "Feathering" paddle-floats are now generally employed; the common paddle-floats being fixed radially upon the wheels. The *speed* of the floats depends upon their radial distance from the centre of the wheel and the number of revolutions of the wheel in a unit of time. Suppose the centre of the floats to be 16 feet from the centre of the wheel, and the wheel to make 16 revolutions per minute. Then speed of floats in feet per second (V) would be given by

$$V = \frac{2 \times 3.1416 \times 16 \times 16}{60} = 26.8 \text{ feet (nearly).}$$

If the speed of the ship is called v , the difference ($V - v$) between that speed and the speed of the paddle-floats is termed the *slip* of the paddles, and is usually expressed as a fraction of V , or

$$\text{Slip (per cent.)} = \frac{V - v}{V} \times 100.$$

Suppose in the example chosen—which is taken from an actual ship—that the speed v is 22.4 feet per second (about 13 knots per hour):

$$\text{Slip (per cent.)} = \frac{26.8 - 22.4}{26.8} \times 100 = 16\frac{1}{2} \text{ (nearly).}$$

From 15 to 20 per cent. appears to be a fair average for the slip of paddle-wheels when working under favourable conditions. Being usually placed amidships, they operate on water which has its maximum sternward velocity relatively to the ship, and this fact somewhat reduces the efficiency. With a certain speed of revolution it lessens the

sternward momentum which the floats can impress upon the paddle-race. With a certain indicated power, the speed of the paddle-wheels may be increased in consequence of working in the disturbed water, but the waste work on the engine, friction, "churning" of the water, &c. will be also increased; so that there must be less efficient action than if the paddle worked in still water. If the motion of the water be disregarded, and the paddles assumed to operate on water which is undisturbed by the passage of the ship, it is easy to express the thrust of the propeller. Let A = cross-sectional area of the paddle-race on both sides. Then, if V and v have the same values as in the preceding equations for slip of paddle-wheels,

$$\begin{aligned} \text{Cubic feet of water acted upon per second} &= A \cdot V; \\ \text{Thrust: or momentum created per} & \\ \text{second in sea-water} & \left. \begin{array}{l} \\ \\ \end{array} \right\} = 2AV(V - v), \text{ nearly;} \end{aligned}$$

the exact determination of A is not an easy matter. With the common or radial float it is generally supposed to equal the product of the length (or transverse measurement) of the floats into their maximum depth of immersion; whereas with feathering floats it is assumed equal to the area of the float. Certain rules have been established by experience for fixing the size of the paddle-wheels, the length of the floats, their breadth, and maximum immersion. Mr. Scott Russell summarises these rules as follows: *—The size of the paddle-wheel should be determined by considering the intended speed of the ship, the average slip of the paddles in similar vessels, and the number of revolutions per minute considered most suitable for the engines. † The height of the paddle-shaft and of the engines in the ship should also be noted, in order to determine their effect on the stability. In the fully laden condition of the ship the wheel should not

* See his work on *Naval Architecture*.

† From the comparison of a great number of high-speed paddle

steamers, we find that from 20 to 30 revolutions per minute were common, but in some cases 40 to 45 revolutions were made.

be buried in the water more than one-third to one-half its radius; in the light condition the upper edges of the paddle-floats should be at least 6 inches under water when they are vertical. The length (or transverse measurement) of the floats should not exceed one-third or one-half the breadth of the ship except in special cases. In a radial or common paddle-wheel the number of the floats should about equal the number of feet in the diameter; and the breadth of the floats should be about $\frac{3}{4}$ inch or 1 inch for each foot in the diameter. In a feathering paddle the floats should be about one-half as numerous and twice as large as the floats in a common paddle-wheel. These are only approximate rules for deep-water steamers; for shallow draught vessels these rules would not be followed, but the special conditions on which a vessel was to be employed would be considered.

The chief practical difficulty with paddle-wheels applied in large sea-going steamers was connected with the variations in their performance, produced by changes in the draught of water and the immersion of the floats. In performing a long voyage, the consumption of coal and stores might produce a change of draught amounting to several feet; and the paddle-floats which were too deeply immersed to be most efficient when the voyage began, might not be sufficiently immersed when it ended. When variations in draught are not considerable, the voyages being short, and the changes in the weights small, paddle-wheels can be employed with the greatest success. Rolling motions, of course, greatly affect the action of paddles in ships at sea, and not merely influence their propelling effect, but give rise to serious straining actions upon the propelling apparatus. A paddle-wheel at one instant submerged far below its normal depth, and having its revolutions retarded by the change, might a few seconds after, on the roll of the ship in the opposite direction, be lifted almost clear of the water and "race" violently beyond the normal speed. In smooth water no similar disturbances of the regular action of paddles occur; and they are there applied with the greatest advantage.

Paddle-wheels, notwithstanding their direct rearward action in the water, do a considerable amount of waste work, besides that which is necessary in repelling a ship. This waste work consists in overcoming the resistance offered by the water to the entry and exit of the floats, and in maintaining the water—surface of a ship other than the rearward direction, venting the bow, etc. Various devices have been proposed for lessening this waste work, feathering paddles being the most common. International investigation shows that, with the best modifications, the waste work at least equals the work done in giving rearward motion to the water.

The action of the paddle-floats must exercise some influence upon the stream-line motions of the water past the ship, and consequently affect the resistance. The water in the paddle-channels would, if the ship were towed, move in around the stern and probably have some small motion in the direction of her advance, forming a "wake". But by the action of the paddles it is driven astern with a considerable velocity, and this change must be equivalent to an increase in the resistance experienced by the ship when self-propelled, as compared with the resistance measured by a tow-rope system. It is, however, to be noted that the paddles would rarely, if ever, be immersed to more than one-third or one-half of the draught of water, so that the disturbance of the stream-line motions may not extend to the greater portion of the water surrounding the ship and at any instant affected by her motion. In the case of the screw-propeller it will be shown that there is a marked difference in this respect, the action of the propeller directly affecting a far greater body of the surrounding water.

Comparing paddle-wheels with water-jets, it appears that the waste work of paddles is probably not greater than, if so great as, that of jets, when allowance is made for the frictional resistances experienced by the water in passing from the inlets to the nozzles. Paddle-floats, moreover, can be made much larger than can the sectional areas of nozzles

without serious practical inconveniences. Hence, on the whole, paddles appear preferable to jets, and they are equally applicable even in the shallowest waters, except, perhaps, in cases where very narrow channels have to be navigated; but even under these special circumstances the paddle is commonly used, being placed astern instead of amidships. When paddles are fitted so that they can be disconnected, and the wheels on opposite sides of a ship worked in opposite directions, they give as great manœuvring power under steam as water-jets; besides being more efficient propellers. On the other hand, paddles are more liable to injury than the nozzles for water-jets: and this difference is of special importance in war-ships.

In concluding these remarks on paddle-wheels, it may be added that, although they have now given place to screws in nearly all sea-going steamers, yet the highest speeds yet attained by ships on smooth-water measured-mile trials have been attained by paddle-steamers. The Holyhead packets steamed $17\frac{1}{4}$ knots; her Majesty's yacht *Victoria and Albert*, 17 knots; and many other vessels have steamed from 15 to 16 knots; all of these speeds being very high as compared with the measured-mile speeds of the finest screw-steamers of the present day. Measured-mile performances do not necessarily afford a fair comparison of the average speeds attained at sea, and in the maintenance of speed at sea screw-steamers undoubtedly gain upon paddle-wheel vessels.

Before proceeding with the discussion of the special features of screw-propellers, it will be desirable to explain a few of the terms that will be frequently employed. The *diameter* of a screw is measured from the circle swept by the tips of its blades during their revolution; the area of this circle measures the *screw-disc*. The *pitch* of a screw is the length of a complete turn measured parallel to the axis; in other words, it is the distance which the screw would advance in one revolution if it worked in a solid nut. The *speed* of a screw is the distance it would advance in a unit

of time for which it acts in such a unit, and is nearly equal to the product of the number of its revolutions, in that unit of time, by the pitch. The difference between the speed of the screw (say 7 feet per second) and the speed of the ship (say 13 feet per second) is usually termed the slip of the screw, and expressed as a percentage of the speed of the screw. For example, a screw of which the pitch is 14 feet makes 72 revolutions per minute, and drives a ship 8.2 knots per hour: required the slip.

$$\begin{aligned} \text{Speed of screw} &= V = \frac{72 \times 14}{60} = 16.8 \text{ feet per second.} \\ \text{Speed of ship} &= v = 8.2 \times 1.688 = 13.8 \text{ " " " "} \\ \text{Slip (per cent.)} &= \frac{V - v}{V} \times 100 = \frac{3}{16.8} \times 100 = 17.85. \end{aligned}$$

This slip ($V - v$), if the screw worked in water undisturbed by the passage of the ship, would clearly be the sternward velocity relatively to still water of the particles in the propeller race. In practice, however, the screw works in water which has been disturbed by the passage of the ship; and hence, strictly speaking, the slip ($V - v$) should be termed the *apparent slip*. The *real slip* may be defined as the total change in the velocity of particles in the race produced by the action of the propeller. The frictional drag of the ship usually produces a forward motion of the surrounding particles, and forms a wake, in which the screw works; it then has to destroy this forward motion before it can impress a sternward motion, relatively to still water, upon the race; but the apparent slip takes account only of that sternward motion, and hence may differ considerably from the real slip. In some cases the curious phenomenon of apparent "negative slip" is observed, the speed of the screw being less than that of the ship; but more commonly the apparent slip is positive, and varies from 10 to 30 per cent., 20 per cent. being the average in very many cases. It lies outside our present purpose to enter further into the discussion of the causes governing the slip of screw-propellers;

the reader desirous of following it out will find several valuable papers on the subject published in the *Transactions* of the Institution of Naval Architects.

The thrust of a screw-propeller, like that of a paddle or jet, is measured by the sternward momentum generated in the race per second. This race is generally assumed to consist of a cylindrical column of water, having the screw-disc, less the circle swept by the "boss" of the screw, for its athwartship section. The surfaces of the screw are oblique, departing more or less from coincidence with athwartship planes; whereas paddle-floats are placed athwartships, and the jet delivers its column directly sternwards. This oblique action of the screw-propeller constitutes an important difference between it and the other two propellers; rotary as well as sternward motion being imparted to the race. This rotary motion must be accompanied by centrifugal action, producing some diminution of pressure of the screw upon the water, and some loss of thrust. As the screw revolves, it also experiences frictional resistance on its surfaces from the surrounding water, and this has been proved to be an appreciable item in the total work of the engines, producing a diminution of the thrust.

All these drawbacks to the efficiency of screw-propellers are, however, unimportant when compared with the increased resistance produced by their disturbing action upon the stream-line motions of the water surrounding a ship in motion. The natural flow of the streams, as previously explained, causes them to close in around the stern and produce a forward pressure, which counterbalances, to a large extent, the sternward pressure of the streams upon the bow. When a rapidly revolving screw is placed close to the stern, and made to give sternward momentum to large quantities of water, there is a lessened forward pressure on the stern, while the sternward pressure on the bow remains nearly the same as before. Consequently, there is a considerably increased resistance. For many years past these general considerations have been agreed to, but it is only

The following table shows the results of the experiments made at Mare Island, California, in 1872, and the results of the experiments made at the Naval Academy, Annapolis, Maryland, in 1873. The experiments at Mare Island were made by Mr. Froude, and the experiments at Annapolis were made by Mr. Isherwood. The results of the experiments at Mare Island are given in the first column, and the results of the experiments at Annapolis are given in the second column. The first column shows the speed of the ship in knots, and the second column shows the strain on the rope in pounds. The results of the experiments at Mare Island are as follows: At a speed of 8 or 9 knots, the strain on the rope was 1,600 lbs., or 37 per cent above the average strain. At a speed of 7 knots, the strain on the rope was 1,100 lbs.—30 per cent greater than the corresponding average strain. At lower speeds the strain on the dynamometer was not nearly so great in proportion to the average strain. These experiments are very interesting, but cannot compare in accuracy with those made under the conditions which Mr. Froude can secure with the aid of his delicate measuring apparatus.

Experiments were also made at Mare Island, California, in 1872, and the results of the experiments are given in the first column of the following table. The results of the experiments at Mare Island are as follows: At a speed of 8 or 9 knots, the strain on the rope was 1,600 lbs., or 37 per cent above the average strain. At a speed of 7 knots, the strain on the rope was 1,100 lbs.—30 per cent greater than the corresponding average strain. At lower speeds the strain on the dynamometer was not nearly so great in proportion to the average strain. These experiments are very interesting, but cannot compare in accuracy with those made under the conditions which Mr. Froude can secure with the aid of his delicate measuring apparatus.

* See a paper on the subject contributed by Mr. Eckart to the *Transactions of the Institution of Naval Architects for 1872*, and Mr.

Isherwood's report published by the United States Navy Department.

and appliances for ensuring the maintenance of uniform motion during each run of a model, at any desired speed.

The adventitious resistance produced by the action of a screw is considerably influenced by its distance from the stern. Almost always the screw is placed close to the stern, and its sweep is so considerable that a very large portion of the water set in motion by the passage of the ship is influenced by its action. But if the screw is placed some distance astern of the ship, it appears to interfere very much less with the natural flow and forward pressure of the streams upon the stern, causing comparatively little increase of resistance. Mr. Froude states as the result of direct experiment that, if a single screw is placed one-third or one-fourth of the extreme breadth of a ship clear of the stern, the increase of resistance produced by its action is only one-fifth of that ordinarily produced. In a few ships the screw has been placed abaft the rudder; this is the arrangement adopted in the swift steam-launches recently constructed. But in no case has it been placed nearly so far aft as the distance indicated by the experiments; nor could it be so placed without incurring serious practical disadvantages, especially in war-ships. A screw placed clear of the stern, instead of under its protection, would run great risks of damage in action; even if it could be satisfactorily supported under ordinary conditions of service.

Notwithstanding these drawbacks, the screw has quite superseded the paddle for ocean navigation and deep-water service, has been proved quite equal to the paddle, if not superior to it, on the measured-mile smooth-water trials of speed, and has surpassed the jet in efficiency on the only occasions when fair comparative trials have been made. It has been questioned whether in smooth water the screw is so effective as the paddle; but the trials in the *Rattler* and *Alecto*, the *Niger* and the *Basilisk*, indicated a decided superiority in the screw, and this opinion has been confirmed by a careful comparison of very many measured-mile trials of paddle and screw steamers of similar types. Pro-

vided that the draught of water of the ship is great enough to permit the use of a screw, or twin-screws, of sufficiently large diameter, it is preferable to use the screws. When the draught is too limited even for twin-screws, multiple screws have been used, but ordinarily the paddle would be employed.

The efficiency of the screw, as compared with the paddle or jet, in smooth water results from the fact that it operates upon much larger quantities of water in a unit of time. The race of a well-immersed screw-propeller has a sectional area approximately equal to the screw-disc; and this is very large even as compared with the largest paddle-race. It is scarcely necessary to illustrate this statement; let one contrast suffice. The famous paddle-steamer *Scotia* and her Majesty's ship *Volage* both attained a speed of about 15 knots on the measured mile. For both paddles in the *Scotia* the sectional area of the race equalled about 130 square feet, and the speed of the floats was about 34 feet per second, that of the ship being 26 feet. For the screw of the *Volage*, the disc area was about 280 square feet, the speed of the screw 30½ feet per second, and that of the ship 25½ feet. On calculation it will be found that the paddles operated on about 4500 cubic feet of water per second, the indicated horse-power of the engines being about 4800; whereas in the screw the quantity of water operated on per second exceeded 7500 cubic feet, the engines indicating 4500 horse-power. It has been shown that the thrust of a propeller depends upon the product of the quantity of water operated upon in a unit of time, by the sternward velocity imparted to it; and since the screw has so large an excess over the paddle in the quantity of water in its race, the waste work due to obliquity of action, screw friction, and centrifugal action is more than compensated for.

Smooth-water performances are not the true test of efficiency; in a seaway the screw is far more superior to the paddle than it is on the measured mile. Rolling motions, which would seriously affect the paddle, leave the screw

almost uninfluenced. Pitching oscillations of course affect the screw more than the paddle; but if the screw is well immersed, or, still better, if twin-screws are employed, the loss of efficiency on account of pitching does not appear to be at all serious in large ships. Considerable variations in the draught of water may also take place, yet leave the screw efficient; whereas it has been shown that this is not equally true of the paddle. The screw lends itself much more readily than the paddle to the association of steam with sail power; the absence of projecting paddle-boxes is a great advantage in steaming head to wind and in general service; and, finally, in war-ships the screw is much less exposed to damage in action. The most convincing argument in favour of the superiority of the screw under all conditions of service is, however, to be found in the fact that it has almost entirely replaced the paddle in sea-going ships of the mercantile marine, wherein economical propulsion is of the highest importance.

From the foregoing considerations it will appear that two conditions are essential to the successful application of screw-propellers: (1) the disc area must be made large; (2) the water must be permitted to flow freely to the screw. With a single screw a large disc means a large diameter; and the superior propelling effect of large screws is now so generally recognised that it is unnecessary to say much in their favour. The well-known trials made twenty years ago with her Majesty's ship *Flying Fish* proved that the larger screw, even if not wholly immersed, might still be used with advantage; and since that time the largest screws that could be employed conveniently have been adopted. Considerable trim by the stern has also been given to many ships, mainly for the purpose of obtaining an extreme draught aft that would permit the use of a large well-immersed screw. In many cases, however, the draught is too limited to permit the employment of a single screw of sufficiently large diameter, and then recourse is had to twin or multiple screws.

Multiple screws have not been used in many cases,

nor in any vessels attaining high speeds. Some of the shallow-draught vessels built for service on the Mississippi during the American civil war had four screws; but their speed was low. The Russian circular ironclads have no less than six screws. In the *Novgorod* each of these screws is $10\frac{1}{2}$ feet in diameter; the aggregate disc area exceeding 500 square feet. No authoritative explanation has been published of the considerations which led to the choice of the number and diameter of these propellers; but an endeavour appears to have been made to secure a collective disc area bearing about the same ratio to the total immersed midship section as would hold in vessels of ordinary form. The area of immersed midship section in ordinary screw-ships, when fully immersed, varies from two to four times the disc area, three times being a good average value; in the *Novgorod* it is about $2\frac{1}{4}$ times the aggregate disc area. Such a large number of screws, situated close together, must, however, have some prejudicial effect upon each other, the race of any screw almost certainly being less defined than it would be if that screw acted alone. And further, although they are placed at some distance abaft the hull proper, their position is such that they must produce, when at work, considerable disturbance of the stream line-motions.

Twin-screws were first used in shallow-draught vessels, but their employment has since been extended to deep-draught vessels with very considerable advantage. The performances of recent twin-screw ships belonging to the Royal Navy show that they gain on single-screw ships of similar size, form, and speed, being driven with a less expenditure of power. Taking, for example, the ratio of the indicated horse-power to (displacement)³ as an index of the relative economy of power, which may be done without unfairness under the conditions stated,* and comparing the performances of a

* See the remarks on page 486 as to the use of (displacement)³ as a measure of the frictional resist-

ance. What is here assumed is that in very similar vessels the total resistance will vary as the frictional resistance for the same speeds.

number of ships when steaming at the uniform speed of 14 knots, the average ratio for the single-screw ships is about 17·5 against 15·5 for the twin-screw ships, or about 11 per cent. in favour of the latter.

This superiority in propelling effect is obtained in association with other important advantages. The engines and propellers being duplicated, it is possible to make use of a middle-line watertight bulkhead (as shown in Figs. 18–25, page 30), and to greatly increase the safety of the ship against foundering. There is also far less risk of entire disablement than with a single screw; and, with either screw at work, a twin-screw ship is not merely under control, but able to make fair headway. The *Vanguard*, for example, with one screw steamed 11·4 knots, while with both screws she attained 14·9 knots; and in many cases long passages have been made by twin-screw ships, with a single screw at work and a small angle of helm to keep the course. So manifold are the advantages of twin-screws that all the large ships now building for the Royal Navy are to be propelled in that manner, the armed despatch vessels *Iris* and *Mercury*, which are intended to have a speed of 17 or 18 knots on the measured mile, being among the number. Single screws are now used only in cases where cruising qualities are of great importance and the sail-power is good; it is then desirable to lift the screw when under sail alone, and single screws are used chiefly because no satisfactory plan has yet been devised for lifting twin-screws. In view of these facts it seems a matter worthy of the gravest consideration of merchant ship owners whether twin-screws might not be introduced into ocean steamers, which now almost without exception have single screws, any slight accident to which or to the machinery may disable the vessels as steamers, and throw them back upon their sail-power. It has been objected that twin-screws are more exposed to injury by collision, fouling of wreckage, &c., than single screws, which are sheltered under the stern; but while there is undoubtedly force in the objection, it can scarcely

be regarded as a counterbalance to all the advantages obtainable with twin-screws.

The second condition essential to the efficiency of screws is that they shall have a good supply of water, in order that the race may have its full sectional area, and the whole of the propeller-disc may be creating momentum and exercising thrust. Amongst the more important circumstances influencing the supply of water to the screw may be mentioned the form of the stern of the ship, the distance of the screw abaft the stern, and the immersion of the upper blades when they are passing through the vertical position. If the screw is not sufficiently immersed, it will create considerable surface disturbance, have a less compact and well-defined race, and do more waste work. If the stern is bluff or very full, the efficiency of the screw will be decreased because the water cannot flow freely to certain parts of the screw-disc, which are masked by the sternpost and body of the ship. If the screw is close under the stern, as it usually is in single-screw ships, it has to act at some disadvantage in the "wake" of the ship, as compared with what it would have to do if placed further astern.

Fineness in the "run" of single-screw steamships is now recognised as a desirable and necessary feature. In the earlier periods of steam propulsion, this was not so well understood, and in many of the bluff-sterned vessels of the Royal Navy, converted from sailing into steamships, the prejudicial effect of their forms on the action of the screw was most marked. One case alone can be cited out of the many on record. The screw-frigate *Dauntless*, built in 1848, was first tried with a full stern, and her performance being unsatisfactory, she was lengthened aft about 10 feet, and made of much finer form in the run. In her earlier trials, when the displacement was 2300 tons, she was driven at a speed of $7\frac{3}{4}$ knots with 836 horse-power (indicated). After the alteration, with the same screw and nearly the same displacement, the ship attained a speed of 10 knots with 1388 horse-power; but

had the form remained unaltered, the engine-power for that speed would have been at least 1900 horse-power, so that the alteration of the stern and better supply of water to the screw saved nearly 30 per cent. in the total power that would otherwise have been required.*

Twin-screws are now usually fitted under each quarter with the deadwood between them, and at some distance clear of the body of the ship, the shafts being carried out in tubes, of which the after ends are supported by struts. Consequently there is nothing corresponding to the sternpost or body of the ship to prevent the free flow of water to the screws; being well immersed, that supply is likely to be ample, and there is but little surface disturbance, the whole of the disc doing useful work on a race which is compact and unbroken. These circumstances no doubt help to make twin-screws efficient; besides which they probably gain somewhat upon single screws in creating less adventitious resistance. We are not aware that this last-mentioned matter has been made a subject of experiment. But it is reasonable to suppose that, being placed some distance clear of the body of the ship, with their shafts well away from the middle line of the ship, while their sweep leaves untouched a considerable part of the streams flowing past the ship near the region of the water-line, the action of twin-screws will not cause so great an additional resistance as results from the action of single screws.

Attention will next be directed to the methods by which, in designing a new ship, an approximation is made to the indicated horse-power required to propel her at a given speed. It has already been stated that the common method is to proceed by comparison of the new design with existing ships; making use of "coefficients of performance" based upon their trials. Such coefficients are determined from the

* In the *History of Naval Architecture*, by the late Mr. Fincham, will be found much interesting information respecting the introduction of screw propulsion into the Royal Navy.

measured-mile trials of all her Majesty's ships, and the mass of valuable information already recorded is of the greatest assistance in the design of new ships. The results of many trials made prior to 1865 have been published by Mr. Scott Russell in his *Naval Architecture*; and the corresponding results for many of the ironclads since constructed will be found recorded in the *Annual* of the Royal School of Naval Architecture.

The Admiralty formulæ may be expressed very simply. Let D = displacement of ship (in tons) at the draught of water on the trial; A = the corresponding area (in square feet) of the immersed midship section; V = speed (in knots) per hour; and P = indicated horse-power. Then

$$C_1 \text{ (midship section coefficient)} = \frac{A \times V^3}{P};$$

$$C_2 \text{ (displacement coefficient)} = \frac{D^{\frac{2}{3}} \times V^3}{P}.$$

In these expressions it is assumed—(1) that the resistance of the ship will vary as the *square* of the velocity, and the work to be done in propelling her as the *cube*; (2) that the useful or propelling effect of the engines, after allowing for the waste work to be done in overcoming frictional resistances, &c. of the machinery, and the waste work of the propeller, will vary as the indicated horse-power; (3) that for similar ships the resistances corresponding to any assigned speed will vary as the area of the immersed midship section, or the two-thirds power of the displacement. The character of the last assumption and the limits within which it may be applied have already been made the subject of comment in the preceding chapter.* As to the first assumption, it is only necessary to refer to Chapter XI., where it has been shown that, so long as the speeds attained do not exceed the limits where wave-making resistance becomes important in proportion to frictional resistance, the law of the total resistance

* See page 486.

varying as the square of the speed holds fairly. Beyond that limit the law of variation involves a higher power of the speed. The second assumption also appears to hold fairly well with engines of similar and good design, and with any selected propeller of good proportions. It cannot, however, be applied without correction when the propellers of the two ships compared are of dissimilar character—one, say, a paddle, and the other a screw; nor can it be applied to all types of engines, the waste work being greater in some than in others. The greater the similarity in ship, engines, and propellers, the greater will be the degree of accuracy possible with this method of estimation.

Even with the foregoing limitations, the coefficients of performance furnish a good means of comparing the economy of propelling power in ships of similar form and proportions, and not very different sizes, as well as of estimating the probable power for a new ship. Of the two coefficients, that for the displacement is, on the whole, the more trustworthy, giving a fairer measure of the resistance than the midship-section coefficient, especially when dealing with ships which are not of exactly similar form.

As an example of the use of these coefficients, take the case of her Majesty's ship *Bellerophon*. On the measured mile, with a displacement of 7369 tons, a midship-sectional area of 1207 square feet, and an indicated power of 6312 horse-power, she attained a speed of 14·053 knots per hour.

$$C_1 = \frac{1207 \times (14\cdot053)^3}{6312} = 531 ;$$

$$C_2 = \frac{(7369)^{\frac{3}{2}} \times (14\cdot053)^3}{6312} = 166.$$

The ship is 300 feet long, 56 feet broad, and had a mean draught of water, on trial, of $24\frac{1}{4}$ feet. Hence her

$$\text{Coefficient of fineness}^* = \frac{7639 \times 35}{300 \times 56 \times 24\frac{1}{4}} = 0\cdot63.$$

* See page 4.

When her Majesty's ship *Hercules* was designed, if the performances of the *Bellerophon* had been known, the engine-power required might have been approximated to in the following manner. Her length being 325 feet, breadth 59 feet, and mean draught $24\frac{3}{4}$ feet, her displacement was 8680 tons, and the area of midship section 1314 square feet. For these dimensions—

$$\text{Coefficient of fineness} = \frac{8680 \times 35}{325 \times 59 \times 24\frac{3}{4}} = 0.64,$$

or nearly the same as the fineness of the *Bellerophon*. It might have been assumed therefore that the *Hercules* would have coefficients of performance very nearly equal to those stated above. On trial the vessel attained 14.69 knots per hour; let this be taken as the designed speed, and let the corresponding horse-power be required. Using the midship-section coefficient 531,

$$\text{Probable I.H.P.} = \frac{1314 \times (14.69)^3}{531} = 7845 \text{ (nearly).}$$

Using the displacement coefficient 166,

$$\text{Probable I.H.P.} = \frac{(8680)^{\frac{2}{3}} \times (14.69)^3}{166} = 8065 \text{ (nearly).}$$

The actual indicated power required to drive the *Hercules* at the speed of 14.69 knots was rather more than 8520 horse-power, or about 6 per cent. above the approximation from the displacement coefficient, and about 9 per cent. above that from the midship-section coefficient. These results bear out what was said above as to the displacement coefficient being on the whole the more trustworthy; and they are sufficiently close to the truth for practical purposes. It may be explained, however, that the variation of the resistance at these high speeds for ships of this type depends upon some higher power of the speed than the square; and the naval architect would allow for this in his estimate, increasing the power somewhat above that given by the foregoing approximate method. In making this increase, he would be guided by

the recorded performances of the exemplar-ship at some less speed than the full speed; nearly all the vessels of the Royal Navy having been tried at half-boiler power as well as full power. For example, the *Bellerophon*, steaming at a speed of 12.15 knots, had a midship-section coefficient of 543, and a displacement coefficient of 171, as against 531 and 166 for a speed of 14.05 knots, indicating that the power required to drive the ship varied with a higher power than the cube of the speed. It really varied between those speeds as $V^{3.3}$; and if this correction is made for the *Hercules* in the preceding calculation, the probable indicated horse-power will rise to 8300, or within $2\frac{1}{2}$ per cent. of the power actually developed. To ensure the attainment of the speed desired, the naval architect would almost certainly provide some margin of indicated horse-power above that to which the approximate method conducts.

The difficult part of the work in practice lies in the selection from available data of exemplar-ships most nearly resembling the new design, in order that the appropriate coefficients may be obtained. In making this selection, it is necessary to compare carefully the fineness of form, the dimensions, the lengths of entrance and run in proportion to the maximum speeds, and some other particulars of the new ship and the completed ships; and to make allowances for greater or less fineness of form, differences in the frictional resistance, or any other matter affecting the speed under steam. In the Royal Navy, for the greater number of classes, little difficulty is experienced in discovering suitable examples; but when entirely new conditions are introduced, it is not possible to proceed with equal certainty, and then it becomes necessary, in proceeding by this comparative method, to allow a considerable margin of power and speed.

Take, for example, the *Devastation*, a vessel of very full form, moderate proportions of length to beam, and one of the earliest deep-draught twin-screw ships. It was estimated in designing this ship that with 5600 horse-power and a displacement of 9060 tons, a speed of at least $12\frac{1}{2}$

knots would be obtained ; this would give a displacement coefficient

$$C_2 = \frac{(9060)^{\frac{3}{2}} \times (12\frac{1}{2})^3}{5600} = 151.$$

On the measured mile, with a displacement of 9190 tons, the ship steamed 11.91 knots with 3400 horse-power, the displacement coefficient being 218 ; and at full speed she realised 13.84 knots with 6650 horse-power, the corresponding coefficient being 175. Had only the estimated power—5600 horse-power—been realised, the vessel would have steamed about 13 knots, that is, about $\frac{1}{2}$ knot faster than the estimated speed. Or, had she steamed $12\frac{1}{2}$ knots, the indicated horse-power required would have been only 4000 horse-power, instead of 5600 horse-power, as estimated.

When the *Devastation* had been tried and her coefficients determined, it was an easy matter to determine the appropriate engine-power for the succeeding deep-draught ships with twin-screws ; and the superior performances of twin as compared with single screws rendered it possible to economise engine-power. This was done ; and in the *Alexandra*, *Temeraire*, and other vessels, the engines were made less powerful and weighty than they would have been with single screws. Subsequent trials have fully justified this procedure. Take, for example, the *Alexandra*. It was estimated that 8000 horse-power would suffice to drive the ship about 14 or $14\frac{1}{2}$ knots, when fully laden and weighing 9500 tons. On the measured mile the speed of 15 knots was attained, and the engines exerted 8600 horse-power, 600 horse-power more than the guaranteed power. When allowance is made for this excess of power, it appears from calculation that the fully laden ship would have exceeded the upper limit of her intended speed with 8000 horse-power. Had she been fitted with a single screw, instead of twin-screws, in all probability at least 500 or 600 horse-power additional would have been required to attain the same speed.

The second method of approximating to the engine-power required in a new ship has already been mentioned ; viz.

the performance of model experiments, the inference therefrom of the resistances of full-sized ships, and the due proportioning of the effective horse-power, required to overcome the resistances, to the indicated horse-power of the engines.* Until recently, scarcely any data were accessible as to the ratio of the effective to the indicated power. This ratio, as explained in an earlier part of the chapter, will vary according to the type of engine and kind of propeller used; and until it has been determined, the results of the model experiments cannot be made of much service, except in selecting the forms and proportions which minimise resistance. The most important case is that for screw steamships, and it has been carefully investigated by Mr. Froude in a manner which leaves nothing to be desired.† In the case of the *Greyhound* at her full speed of 10 knots, the effective horse-power is stated to have been 42 per cent. of the indicated; and at a speed of 8 knots it was 35 per cent. In the *Merkara*, at the trial draught the corresponding percentage was 42. As the result of the analysis of numerous examples of single-screw ships, Mr. Froude states that, "as a rule, only from 37 to 40 per cent. of the whole power delivered is usefully employed." No corresponding analyses have been made for twin-screws, paddles, or jets.

A very useful practical rule for screw-steamers may be based upon this deduction from experiments. Having found by model experiments the resistance of a ship at her intended maximum speed, and the corresponding effective horse-power, the indicated horse-power required to drive the ship at that speed will be approximately $2\frac{1}{2}$ times the effective horse-power if a single screw is used. With twin-screws, possibly, the ratio of the indicated to the effective powers would be somewhat less; with paddles, somewhat greater; and with jets, as commonly applied, greater still.

* See the explanation given at page 464 of the process by which the resistance of a ship may be obtained from that of a model; and that at page 510 of the terms

"effective" and "indicated" horse-power.

† See vol. xvii. of the *Transactions* of the Institution of Naval Architects.

This method of approximating to the engine-power is more to be preferred, when several types of ships are to be tried, in various speeds, attached. Unlike the first method, based upon the law of resistance, it does not assume that the resistance varies as the square of the speed—which may be, and is often, very far from the truth. This is taken account of the actual resistance, and whatever may be the true law of its variation, in terms of the speed, that law is incorporated in the result. On the other hand, if model experiments are made, the greatest care must be taken to eliminate errors from the results, and particularly any connected with the measurements of speeds or resistances. Otherwise errors which are of small amount with the models may become magnified in passing to the full-sized ships, and very seriously affect the estimates for the engine-power.

When the performances of steamships on the measured mile have been recorded, if they have been tried at several speeds, it is possible to apply the method of comparison proposed by Mr. Froude, in estimating the probable engine-power for a new design, and to pass from a small to a large ship, and from one speed to another, with greater certainty than by the method of coefficients. This advantage is obtained by avoiding the assumption that the resistance varies as the square of the speed, and by making allowance for the difference of size by obtaining what Mr. Froude has termed "corresponding speeds."* An example will best explain the process: we will choose her Majesty's ships *Hercules* and *Greyhound*, which are very similar in form, but different in size and speed.

Ship	Length	Breadth.	Mean Draught.	Displacement on Trial.
	Feet	Feet.	Feet.	Tons.
<i>Hercules</i>	325	59	24.6	8676
<i>Greyhound</i>	172½	33½	13.7	1157

* See the explanation given at page 462.

The similarity of the forms will appear from comparing the ratios of the lengths, breadths, draughts, and cube-roots of the displacements. Using the letter D to express this ratio, we have,

$$D = \sqrt[3]{\frac{8676}{1157}} = 1.957;$$

$$\sqrt{D} = \sqrt{1.957} = 1.4 \text{ (nearly).}$$

On trial, the *Hercules* attained a speed of 14.69 knots.

$$\left. \begin{array}{l} \text{Corresponding speed} \\ \text{for } \textit{Greyhound} \end{array} \right\} = \frac{14.69}{\sqrt{D}} = \frac{14.69}{1.4} = 10.5 \text{ knots (nearly).}$$

On trial, the *Greyhound* attained a maximum speed of 10.04 knots with 786 indicated horse-power; at that speed her resistance was varying about as the *cube* of the velocity, and therefore the horse-power would vary as the fourth power. Hence

$$\left. \begin{array}{l} \text{Indicated horse-power for} \\ \text{speed of 10.5 knots} \end{array} \right\} = 786 \times \left(\frac{10.5}{10.04}\right)^4 = 940 \text{ H.P.}$$

The thrust of the propeller in the *Greyhound* at 10.5 knots might therefore be considered proportional to the quotient $940 \div 10.5$; if for the *Hercules* at 14.69 knots a corresponding assumption is made, and the thrust considered to be proportional to the quotient of the required indicated horse-power (P, say) $\div 14.69$. In both ships the engines would be working at full speed; and for our present purpose it may be assumed that the thrusts would be proportioned to the resistances of the two ships. Using the law of comparison proposed by Mr. Froude,

$$\text{Resistance for } \textit{Hercules} \left. \begin{array}{l} \text{at 14.69 knots} \\ \text{at 14.69 knots} \end{array} \right\} = (1.957)^3 \times \left\{ \begin{array}{l} \text{resistance for } \textit{Grey-} \\ \text{hound at 10.5 knots} \\ \text{resistance for } \textit{Grey-} \\ \text{hound at 10.5 knots.} \end{array} \right.$$

$$= 7.5 \times \left\{ \begin{array}{l} \text{resistance for } \textit{Grey-} \\ \text{hound at 10.5 knots} \end{array} \right.$$

Hence, approximately,

$$\frac{\text{I.H.P. for } \textit{Hercules} \text{ at } 14\cdot69 \text{ knots}}{14\cdot69} = \frac{7\cdot5 \times 940}{10\cdot5};$$

$$\text{I.H.P. for } \textit{Hercules} \text{ at } 14\cdot69 \text{ knots} = 9870 \text{ horse-power.}$$

This power is largely in excess of that actually developed in the *Hercules*, when she attained the speed of 14·69 knots; but it must be remembered that in the calculation the same coefficient of friction has been assumed for the *Hercules* as for the *Greyhound*; whereas the *Hercules* was tried with a cleanly coated iron bottom, and the *Greyhound* with a coppered bottom deteriorated by age. A correction is therefore necessary, and it may be simply made.

Mr. Froude estimated that for a speed of 600 feet per minute the coefficient of friction for the bottom of the *Greyhound* was about 0·325 lb. per square foot of surface, as against 0·25 lb. for a cleanly painted iron bottom; and this difference would involve an increase of between *one-seventh* and *one-eighth* in the total resistance and indicated horse-power for the speed of 10·5 knots. In other words, if the *Greyhound*, instead of being tried with her worn copper, had been tried with a cleanly coated iron bottom like that of the *Hercules*, the speed of 10·5 knots would have been attained with about 830 horse-power, instead of 940 horse-power. Making this correction in the foregoing equation, we have, approximately,

$$\begin{aligned} \text{I.H.P. for } \textit{Hercules} \text{ at } 14\cdot69 \text{ knots} &= \frac{7\cdot5 \times 14\cdot69 \times 830}{10\cdot5} \\ &= 8715 \text{ horse-power.} \end{aligned}$$

This is a close approximation to the actual power (8529 horse-power) which was developed on the measured-mile trial of the *Hercules*; and although the same degree of accuracy may not always be secured in estimates made in this manner, the principal steps in the process will resemble those illustrated in the foregoing example.

In the design of all steamships *economical propulsion* is an important object. In war-ships it is seldom the governing

condition, whereas in merchant ships it generally occupies the first place. It is unnecessary to repeat what has already been said respecting the contrast between mercantile and fighting ships;* but it may be advantageous to summarise the circumstances which chiefly influence economy of steam-power.

First, and most influential, is the adoption of forms and proportions which lead to *diminished resistance*. Examples of the remarkable effects produced by increasing the length, the proportion of length to breadth, and the fineness of form, were given in Chapter XI. To these may now be added a few others, as the subject possesses considerable interest. The largest Transatlantic mail steamers are about equal in weight to the largest ironclad frigates of the Royal Navy; and the measured-mile speeds of the two classes are not very different, being from 14 to 15 knots. In the mail steamers the length is from 9 to 11 times the beam; in the earlier ironclad frigates, such as the *Warrior* and *Minotaur*, it is from $6\frac{1}{2}$ to $6\frac{3}{4}$ times; in the later ironclad frigates, such as the *Hercules* and *Alexandra*, from 5 to $5\frac{1}{2}$ times. For our present purpose it will be sufficient to compare the indicated horse-power with the total weights driven; if this mode be followed, the vessels compare as under:—

	H.P.	
Transatlantic steamer	0.5	per ton of displacement;
Earlier ironclad frigates	0.6 to 0.7	„ „ „
Later „ „	0.9 to 1	„ „ „

These are *average* values for the different classes; and they illustrate the considerably increased expenditure of power rendered necessary in the recent ironclads by reason of their moderate length and proportions.

To compare only the performances under steam of these various classes, and not to have regard to their contrasts in other respects, would be very misleading. The merchant

* See page 454.

steamer is built for remunerative service in carrying cargo and passengers; handiness, or quick turning, is of minor importance. In a modern war-ship, on the contrary, handiness is of the utmost importance, and to secure this quality, moderate length is needed. Adopting the moderate length, and being limited in draught, the displacement required has been obtained by greater beam and fulness of form, which cause greater resistance. But the price paid for increased manœuvring power under steam might not be too high, even if it were wholly additional to the cost of the long ship. In ironclad ships, however, this is not the case; but reckoning the total cost of hull and engines, the shorter type of ship can be made smaller and cheaper than a ship of the longer type fulfilling the same conditions as to speed, armour, armament, and coal endurance.

This question was very exhaustively discussed by Mr. Reed when Chief Constructor of the Navy, in order to justify his policy in passing from the *Warrior* and *Minotaur* types to the moderate proportions of the *Bellerophon* and *Hercules*.* From the many illustrative cases adduced by Mr. Reed, we will select one which seems to have peculiar interest. Taking the ironclad frigate *Hercules*, of which all the particulars and performances were known, Mr. Reed proceeded to determine the dimensions and cost of a vessel which should have the same battery and guns, the same armour protection on the water-line belt, the same speed and coal supply, and which should be constructed on the same system as the *Hercules*; the proportion of length to breadth and the coefficients of performance under steam were, however, to be identical with those for the *Minotaur*. The following tabular statement shows the result of careful calculations:—

* See a paper contributed to the *Transactions* of the Royal Society in 1868, and chap. ix. of *Our Ironclad Ships*.

Particulars.	New Ship (as estimated).	<i>Hercules</i> .
Length (in feet)	385	325
Breadth (in feet)	57½	59
Displacement (tons)	9088	8676
Weight (in tons) of—		
Hull	4574	4022
Armour and backing on belt	1518	1292
" " " on batteries	398	398
Engines, boilers, and coals	1460	1826
Equipment and armament	1138	1138
Indicated horse-power for speed of 14·69 knots	6585	8529
First cost of—	£	£
Hull	326,500	287,400
Engines } at average prices for ironclads } built prior to 1869	55,500	72,000

After crediting the long ship with less powerful and costly engines, it appears, therefore, that the total cost of the *Hercules* for hull and engines would be about £22,000 less. The more powerful engines of the *Hercules* would undoubtedly be more expensive to keep at work, owing to their greater consumption of fuel; but, as Mr. Reed remarks, "the interest at a low rate on the difference of prime cost would quite make up for the additional cost of fuel in the *Hercules*, supposing her to be in commission and on general service." The longer and larger ship, moreover, would be more costly to man and maintain in repair; but her most serious drawback would be her slow rate of turning as compared with the *Hercules*. On her trials at the measured mile the *Hercules* turned a complete circle in 4 minutes, the diameter being about 560 yards, or rather more than five times her own length. What the corresponding figures for the new ship would be with equal rudder-power, it is not easy to decide apart from trial; but it is worth notice that the *Warrior*, a ship of equal length, occupied from 7 to 8 minutes in turning a circle of 750 yards in diameter. The contrast needs no further comment; it is generally admitted that very great advantages are obtained by adopting moderate proportions and accepting the greater expenditure of steam-power.

From the various statements given above, it will appear that the important point is which the *Ironclad* gives more speed than is to be expected if her armour were thickened to the proposed length. This matter—the main object of the present—must exercise great influence upon the selection of the form and proportions most appropriate in principle. And Mr. Eddowes has shown that within certain limits of the ratio of length to breadth, as armour is thickened, the greatest speed of vessels will gain upon the longer. In the course of experimental trials, another consideration has arisen, viz. the selection of proportions which shall secure sufficient stability for the ships when their manœuvring circles are riddled. The *Isabelle*, for example, has a less ratio of length to breadth ($4\frac{1}{2}$ to 1) than any ironclad of equal speed yet designed; but by fining the extremities it is expected that her performance will be nearly identical with that of other vessels of recent design with ratios of length to breadth of 5 or $5\frac{1}{2}$ to 1. Even if this result could not be secured, it would, however, still be desirable to adopt the great proportionate beam for the reason stated.

In the ironclad reconstruction, as armour has been thickened, the ratio of length to breadth has been reduced; and so far as the Royal Navy is concerned, there is no reason to suppose that anything but advantage has resulted from the change. It is possible, however, that the resistance at the high speeds of 14 or 15 knots, considered necessary in battle-ships, would become so great in vessels having extremely large ratios of breadth to length as to make it impolitic to adopt such proportions. The extreme case of the Russian circular ironclads will enable fuller explanations to be given on this point; and the extraordinary character of these vessels will appear from the following brief statement.

The vessels were originally designed for coast defence services in the shallow waters of the Black Sea; it was desired that they should carry thick armour and heavy guns; and the circular form was chosen because it gave

the least surface and the greatest carrying power in proportion to the displacement. It may be admitted that, if these vessels had been stationary floating forts, this view of the matter would have been correct; in the completed ships the hull is said to weigh only about *one-fifth* of the displacement, whereas in vessels like the *Devastation* about 30 or 35 per cent. of the displacement is expended on the hull. But when from mere stationary flotation we pass to the case of locomotion, even at moderate speeds, the conditions are far less favourable to the circular form. It is admitted as the result of careful experiments made by Mr. Froude, and confirmed by the performances of the *Novgorod*, that a circular ship experiences about *five times* as great resistance as a ship like the *Inflexible* or *Devastation* moving at equal speed. Let it be supposed that a circular ship is required to be built to steam as fast and as far as the *Devastation*, and to carry the same dead-weight of armour, guns, &c., exclusive of engines and coals. The same type of engine is to be used in both cases, and the rate of coal consumption is to be identical in both. Taking the Parliamentary Return for the *Devastation*, it appears that the following is the distribution of weights:—

Engines (developing 6600 horse-power) .	1000 tons.
Coals	1350 „
Hull	2880 „
Dead-weight carried	4070 „
	—
Total displacement	9300 tons.

The engines of the *Devastation* are of the surface-condenser type, which preceded the compound principle now generally adopted; and they consume about 3¼ lbs. of coal per indicated horse-power per hour. Had they been of the compound type, about 900 tons of coal would have sufficed to carry the ship as far as she can steam with her present engines, and the engines would have been 250 tons heavier. Suppose, therefore, that the total weight

of engines and coals remain as in the actual ship, the coals carried being 1100 tons, and weight of engines being 1250 tons; we shall have brought the *Devastation* to the conditions of present practice. What would be the dimensions of the corresponding circular ship? is the question to be solved. Using the data furnished by Lieut. Goulaeff, of the Russian navy,* who argues strongly in favour of the novel type, it appears that the displacement of a circular vessel carrying 4070 tons dead-weight, exclusive of engines and coals, and steaming as fast and as far as the *Devastation*, would be at least 20,200 tons. The weights would be distributed somewhat as follows:—

Engines (developing about 34,000 horse-power)	6,430 tons.
Coals (to steam $6\frac{2}{3}$ days at full speed)	. . . 5,700 "
Hull (20 per cent. of displacement)	. . . 4,000 "
Dead-weight (as in <i>Devastation</i>)	. . . 4,070 "
Total displacement	. . . <u>20,200 tons.</u>

If the proportions of the existing ships were followed, this vessel would be about 230 feet in diameter and $19\frac{1}{2}$ feet draught. The circumference at the water-line would be about 720 feet; whereas the total length of the water-line requiring to be armoured in the *Devastation* would not exceed 640 feet; and consequently an armour belt of equal depth and thickness on the two ships would weigh about one-eighth more for the circular ship than for the *Devastation*. The deck area of the circular ship would be about 41,000 square feet; the corresponding area in the *Devastation* would not exceed *one-third* that for the circular ship; and here, for equal protection, the *Devastation* would be at a great advantage. On the upper and breastwork decks of the *Devastation*, the mean thickness of the plating may be taken at $2\frac{1}{4}$ inches; the total weight as about 500 tons. On the

* In a paper published in the *Transactions* of the Institution of Naval Architects for 1876.

circular ship, $2\frac{1}{4}$ -inch plating over the whole area of the deck would weigh about 1600 tons.

It is needless to pursue this investigation further, for no one is likely to contemplate the construction of a vessel nearly twice as heavy as the heaviest existing ships, when it can be shown that in every respect the circular form compares disadvantageously with other existing types. Moreover, it has yet to be proved that vessels of the circular form can be driven at such speeds as 14 knots, without serious departures from the normal trim and draught. Mr. Froude has stated, as the result of experiments with circular models, that, as the speed is increased, the vessels "dive" below their normal draught; and this circumstance deserves careful consideration in discussion of the merits of such ships. The existing ships are reported to have made very low speeds, from 7 to 10 knots, although they have a very large amount of engine-power in proportion to their displacement. The *Novgorod*, for example, had engines of 480 nominal horse-power, said to develop about 2200 horse-power (indicated); her displacement is 2490 tons; and the speed about $7\frac{1}{2}$ knots. Contrasting this with the performance of the monitor *Abyssinia*, which, with a displacement of 2800 tons, was driven $7\frac{1}{2}$ knots by 560 indicated horse-power, the reader will obtain another proof of the extravagant expenditure of power required in the circular ships. For their special purpose they may be exceedingly well adapted, but they cannot be regarded as models for general service. At the same time, the information derived from their performances is most valuable and instructive.

Economical propulsion for any selected type is favoured by *increase in the sizes* of ships. This is true generally; but before taking the general case, it may be well to take the particular case where the resistance varies as the square of the speed. Suppose two similar ships to be compared, the weight of one being W_1 and that of the other W_2 ; let D be the ratio which the length, or any other dimension, in the

weight V varies with the corresponding dimensions in the other. Thus: $V \propto L^3$ and $V \propto V^3$

$$V = L^3 \cdot V_1$$

the weight increasing with the cube of the ratio of corresponding dimensions. In the same ratio an increase in speed will, the resistance will vary to the seventh power of the corresponding power of the displacement, and if R_1, R_2 represent the resistances.

$$\frac{R_2}{R_1} = \frac{V_2}{V_1} = \left(\frac{L_2}{L_1}\right)^7 = \left(\frac{V_2}{V_1}\right)^7$$

the resistances increasing only with the seventh of the ratio of corresponding dimensions. If of similar & solid forms of any size or metal and two as fast as another will have eight times as great displacement, but when moving at the same speed will experience only four times the resistance, and require only four times the engine-power. No longer the larger ship would require to have greater structural strength than the smaller; and consequently the hull might have to be made somewhat lighter in proportion to the displacement, although a usual practice this is rarely done. But even supposing this additional weight if it were added, the larger ship would be the more economical if steam-power in proportion to the tonnage carried.

As an illustration, take the following comparison between two merchant steamers whose performances on the measured mile were recorded, their forms being similar:—

Particulars.	Steamer A.	Steamer B.
Displacement	1530 tons	3690 tons
Indicated horse-power	1620 H.P.	2430 H. P.
Speed	12.9 knots	12.65 knots
Indicated horse-power (Displacement) ³ }	10½	10½

The last line in this comparison shows that the assumed



law holds very closely in these ships. If these vessels were fitted with compound engines, and employed on a service where they would have to steam 3000 knots at full power, their weights would be distributed somewhat as follows :—

Distribution of Weights.	Steamer A.	Steamer B.
	Tons.	Tons.
Weight of engines, &c.	320	480
” ” coals	360	540
” ” hull	550	1240
	1230	2260
” ” cargo and equipment	600	1400
Displacement	1830	3660

The expenditure of 360 tons of coal in the smaller vessel would carry only 600 tons of cargo and equipment over the distance named ; adding 50 per cent. to this expenditure, the larger ship can carry more than twice as much cargo and equipment. This comparison, of course, takes no account of the relative first cost of the two vessels.

Irrespective of any assumed law of resistance, it is possible in general terms to indicate the economy of propulsion obtained by increase in size. Using the same notation as before, let the two ships compared be supposed moving at the speed V , their resistances being R_1 and R_2 . Let R be the resistance of the smaller vessel when moving at the speed $\frac{V}{\sqrt{D}}$; and let it be supposed that between this speed and the speed V the resistance varies with some unknown power ($2n$) of the speed. Then

$$\frac{R}{R_2} = \left(\frac{V}{\sqrt{D}} \right)^{2n} \times \frac{1}{V^{2n}} = \frac{1}{D^n} ; \text{ whence } R = \frac{R_2}{D^n}.$$

Also, by the law of comparison which Mr. Froude has established,

$$R_1 \text{ (for large ship) } = D^3 \times R = D^{3-n} \cdot R_2,$$

$$\frac{R_1}{R_2} = a = D^{3-n} ;$$

and, as before,

$$W_1 \text{ (for large ship)} = D^3 \cdot W_2,$$

$$\frac{W_1}{W_2} = b = D^3;$$

so that finally, for equal speeds of two similar ships,

$$\frac{1}{D^n} \cdot \frac{W_1}{W_2} = \frac{R_1}{R_2}; \text{ or } \frac{a}{b} = \frac{1}{D^n}.$$

The greater the value of n for a certain value of D , the less will be the ratio $\left(\frac{a}{b}\right)$ measuring the ratio of the increased resistance, involved in enlarging the ship, to the corresponding increase in displacement and carrying power. If the resistance between the speeds V and $\frac{V}{\sqrt{D}}$ varies as the *square* of the speed, $n=1$, and the final equation assumes the form

$$\frac{1}{D} \cdot \frac{W_1}{W_2} = \frac{R_1}{R_2},$$

agreeing with that previously obtained for the law of variation. But if the resistance between the speeds V and $\frac{V}{\sqrt{D}}$ varied as the *fourth* power of the speed, then $n=2$, and we have

$$\frac{1}{D^2} \cdot \frac{W_1}{W_2} = \frac{R_1}{R_2}.$$

The comparison of the *Merkara* and *Greyhound* types will enable this contrast to be made more evident. At 12 knots, for the *Merkara*, n may be taken as *unity*, and for the *Greyhound* as 2 nearly; in both ships $R_2 = 20,000$ lbs. Suppose both vessels to have their lengths and other dimensions increased by one-third; then $D = 1\frac{1}{3}$. The *Merkara* has a displacement of 3980 tons; the *Greyhound* one of 1160 tons; the enlarged *Merkara* would weigh 9430 tons, the enlarged *Greyhound* about 2750 tons.

For enlarged *Merkara*, $R_1 = 20,000 \times \left(\frac{4}{3}\right)^2 = 35,555$ lbs.

For enlarged *Greyhound*, $R_1 = 20,000 \times \frac{4}{3} = 26,666$ lbs.

The *Greyhound* type, therefore, gains more in economy of propulsion by enlargement than does the *Merkara*; although the latter type benefits considerably by the same process, and would have much greater carrying power in proportion to the expenditure of fuel as the size increased.

To the foregoing considerations, which have had regard only to smooth-water performances, it is necessary to add one remark. In ocean steaming, the larger, heavier ship is far more likely to maintain her speed under varying circumstances of wind and sea than is the smaller vessel. These two sources of gain in larger ships fully explain the general adoption of the policy which has resulted in very large increase of the sizes of ocean steamers.

Experience has fully confirmed the advantage of these changes. In view of the facts stated at page 348, it may be questioned whether in some of the longest and largest vessels the structural strength might not be increased with advantage. Such an increase would involve either the adoption of improved systems of construction, such as have been sketched in preceding chapters, or additions to the weight of hull, if the structural strength is to be made as great in proportion to the strains as it is in smaller ships. If equally good systems of construction were adopted in two vessels, and equal strength secured in proportion to the strains, then the longer, larger vessel might require to have a heavier hull in proportion to the displacement. This increase in the weight of hull would have to be set against the saving on the propelling apparatus and coals; but it is difficult to decide upon the limits in the ratio of length to breadth and depth for which the increase on hull more than counterbalances the saving on engines and coal. Attempts have been made to solve this problem; but no effect on practice has yet been produced by these investigations.* The largest merchant steamers yet constructed, except the *Great Eastern*,

* See a paper by Mr. Froude, "On Useful Displacement," in vol. xv. of the *Transactions* of the Institution of Naval Architects.

are framed on the transverse system, and have hulls which are very light in proportion to the displacement; yet they can be made capable of withstanding all the strains of service at sea. And experience with the ironclads shows that, if desired, a comparatively small addition to the weight of hull, associated with the adoption of the longitudinal system of framing in merchant ships, would give ample structural strength, and leave the larger ships far more remunerative and economical of steam-power than smaller ships could be.

As an example, take the *Merkara* and the enlarged vessel of her proportions. If 1600 horse-power was required to drive the former at 12 knots, about 2800 horse-power would be required for the latter; and for voyages of equal length at that speed, the coals burnt would have to bear the ratio of the horse-powers. Take 400 tons for the weight of engines, &c. for the smaller ship; then 700 tons will be about the corresponding weight for the larger ship; if the *Merkara* be credited with a coal supply of 500 tons, the larger ship should carry about 880 tons. Suppose further that in the *Merkara* the hull weighs 33 per cent. of the displacement, as is common in merchant ships; whereas in the larger ship it is increased to 40 per cent. Then in the *Merkara* there will remain 1800 tons available for cargo and equipment, which can be propelled over a certain distance by an expenditure of 500 tons of coal; as against 4100 tons in the large ship, which requires an expenditure of less than 900 tons of coal for an equal distance.

Side by side with the development of the sizes and speeds of ocean steamers, there has recently been progressing the construction of a class of very small vessels, possessing remarkably high speeds—the so-called “swift steam-launches” and torpedo-boats. Vessels of from 50 to 100 feet in length have been driven at speeds of from 16 to 20 knots per hour in smooth water, considerably exceeding the measured-mile speeds of the fastest sea-going ships. It is important to investigate the conditions under which these notable results

are obtained ; and fortunately there is on record a complete set of the observations made by an independent observer on the performances of a very successful launch, the *Miranda*.*

This little vessel is $45\frac{1}{2}$ feet long at the water-line, $5\frac{3}{4}$ feet broad, and had an extreme draught on trial of $2\frac{1}{2}$ feet. Her total weight on trial was $3\frac{3}{4}$ tons ; and she attained a speed exceeding 16 knots per hour, when her engines developed about 58 horse-power. According to the principles explained in Chapter XI. the joint lengths of entrance and run required to prevent the inordinate growth of wave-making resistance at this speed would be about 260 feet, or nearly six times as great as the total length of the launch. Hence it might be anticipated that a very great proportionate expenditure of power would be required to drive so small a vessel at that speed ; and this is actually the case, as the following table will show :—

Ship.	Length.	Speed.	Displacement on Trial.	Indicated Horse-power.	Indicated Horse-power per Ton of Displacement.
	Feet.	Knots.	Tons.		
Screw { <i>Inconstant</i>	337	16·5	5328	7361	1·38
{ <i>Volage</i>	270	15·1	3060	4532	1·48
Paddle { <i>Victoria and Albert</i> .	300	18·8	2000	2980	1·49
{ <i>Ismael</i>	250	18·1	1013	2104	2·08
Screw . <i>Miranda</i>	45½	16·2	3·73	58	15·55

Careful observations were made of the surface disturbance which accompanied the rapid motion of the launch, and they appear to show that this disturbance was altogether different in its character from that produced by large ships moving at equal speeds. The trim of the boat altered so considerably, the bow rising relatively to the stern, that her conditions of resistance, apart from the surface disturbance, must have been

* See Mr. Bramwell's valuable paper in vol. xiii. of the *Transactions* of the Institution of Naval Architects. For much information respecting later vessels of the class

designed for using torpedoes, see a paper read before the Royal United Service Institution in May 1877, by Mr. Donaldson.

greatly affected. It is to be noted that the coefficient of fineness of the launch, in terms of the circumscribing parallelogram, is about 30 per cent. only, or about one-third less than that of the finest sea-going ships; a circumstance which tells considerably in favour of the boat. The screw-propeller is also placed abaft the rudder in order to increase its efficiency.

The exceptional character of these vessels appears more clearly when the distribution of the weights is considered. Out of the total weight of $74\frac{1}{2}$ cwt., no less than $40\frac{1}{2}$ cwt. is devoted to engines, boilers, shafting, propeller, &c. in the *Miranda*; and less than one-half of the displacement is devoted to the hull and all the equipment. Placing the various particulars for the *Miranda* and *Inconstant* class opposite each other, and expressing them as percentages of the displacement, the radical differences show themselves more clearly.

Distribution of Weight.	<i>Miranda.</i>	<i>Inconstant</i> Class.
	Per cent.	Per cent.
Engines, boilers, &c.	54	19
Coal supply.	4	11
Remaining weights of hull and equipment .	42	70

The published particulars for the launch do not enable the weight of hull to be given separately; but it is built wholly of steel, the plating being only $\frac{1}{8}$ inch and $\frac{1}{16}$ inch thick, and is therefore very light indeed.

The *Inconstant* class has an exceptionally large percentage of the displacement devoted to the machinery; but in the steam-launch the corresponding percentage is nearly thrice as large. The coal supply of the launch is, on the other hand, very small in proportion to that of sea-going ships; and the equipment of the launch, of course, bears no comparison to that of ships. On the whole, therefore, such a distribution of the weights as is effected in the launch could not be

carried out in sea-going steamers; the hulls would probably be proportionately heavier, the coal supply and equipment must be greater, and the proportionate expenditure of weight on the engines would have to be reduced.

It is, however, in the development of power in proportion to the weight of machinery that these little vessels compare most favourably with full-sized ships. In the *Miranda*, 40½ cwt. of engine, &c. developed 71·6 horse-power; or one horse-power for 0·56 cwt., as against one horse-power for 2½ to 4 cwt. in good marine engines of great power. The remarkable difference is worthy of the careful study of marine engineers, who may find it possible to produce machinery which shall be capable of developing greater power in proportion to its weight than any yet used in sea-going ships, and which shall prove durable, as well as economical in coal consumption. In the steam-launches the locomotive type of boiler has been employed; and there are undoubted difficulties in securing similar lightness in engines of the enormous powers required in large ships. But if the marine engineer can make any progress in this direction, he will greatly assist the naval architect in the endeavour to produce vessels of moderate size and great speed.

Even if such results should be obtained, they will in no way affect the force of the previous argument in favour of the economy of power in large ships. The questions of the weight of machinery required to develop a certain horse-power, and of the horse-power required to drive a ship at a certain speed, are quite distinct. Within certain limits of speed, a vessel of given form and dimensions may be driven without an extravagant expenditure of power. If those limits are surpassed, and wave-making resistance becomes great, then a large expenditure of power is unavoidable, no matter what means may be employed in its development. At the same time, if weight can be saved in the machinery and coals required to produce the requisite engine-power, the saving may be added to the carrying power of the ship; or, for a certain assigned carrying power, a smaller ship may be built

than would be possible if the machinery were of a heavier type.

Experience with these fast steam-launches has not hitherto influenced ship construction; and in view of the radical differences mentioned above, it does not appear likely to do so, except through the progress which may be induced in the practice of marine engineers. An example may exhibit more clearly the magnitude of the advantages which would result from the production, on a large scale, of machinery similar to that used in the steam-launches. If the engines of her Majesty's ship *Inconstant* were so constructed, and were as powerful as the present engines, they would weigh only 230 or 250 tons, instead of 1020 tons. Supposing that the lighter engines were less economical of fuel, 800 tons of coal would probably suffice, instead of the 600 tons actually carried. On the whole, therefore, the change would effect a saving on engines and coals of 550 to 600 tons; which saving might be utilised in various ways, and would be a very large addition to the actual carrying power of the ship, which amounts to 1000 tons, excluding engines and coals. If the latter weight remained the same in a new ship as it is in the *Inconstant*, the new ship might be built with engines of the lighter type, capable of steaming as fast and as far as the existing ship, but of 4000 tons displacement only, whereas the *Inconstant* is of 5328 tons.

The following table exhibits in a succinct form the expenditure of power required to attain certain measured-mile speeds in screw-steamers of different classes and sizes. For ships of the Royal Navy, speed trials are always made and recorded; for merchant ships corresponding trials are often omitted, or are made when the vessels are light. It will be understood therefore that, although the figures given for merchant ships are taken from good examples, they cannot be guaranteed to the same extent as those for war-ships.

Classes of Ships.	Measured-mile Speed.	Length.	Ratio of Length to Breadth.	Displacement.	Ratio of Indicated Horse-power to	
					Displacement.	(Displacement) ^{2/3} .
<i>Ships of Royal Navy.</i>						
Ironclads:—						
Early types } single screw	(14 to 14½	380 to 400	6½ to 6¾	9000 to 10500	0.6 to 0.7	11 to 14
Recent types } single screw	(14 to 15	300 to 330	5¼ to 5¾	7500 to 9000	0.9 to 1	16 to 20
Recent types (twin-screw)	14 to 15	280 to 320	4½ to 5	6000 to 9000	0.7 to 0.9	13 to 19
Unarmoured:—						
Swift cruisers	15 to 16	270 to 340	6½ to 6¾	3000 to 5500	1.3 to 1.5	20 to 24
Corvettes	12½ to 13½	200 to 220	6	1800 to 2000	1 to 1.2	18 to 14
Sloops	11	160	5	850 to 950	1 to 1.2	10 to 11
Gun-vessels	9½ to 11	125 to 170	5½ to 6½	420 to 800	0.8 to 1.4	7 to 11
Gunboats (coast defence) .	8 to 9	80 to 90	3 to 3½	200 to 250	0.8 to 1.1	5 to 7
<i>Merchant Ships.</i>						
Largest mail steamers	14 to 15	400 to 500	9 to 11	7500 to 10000	0.5 to 0.6	10 to 12
Smaller mail steamers	13 to 14	300 to 400	8 to 10	5000 to 7000	0.4 to 0.5	7 to 10
Cargo-carrying steamers	11 to 13	250 to 350	7½ to 10	3000 to 6000	0.3 to 0.5	5 to 9
Ditto ditto	9 to 11	200 to 300	7 to 9	1500 to 4000	0.2 to 0.4	3 to 6

Although the table is confined to comparatively few classes, it represents the conditions of a very large number of ships, and may be of service in roughly approximating to the engine-power required in a new ship belonging to any of these classes. It also furnishes many illustrations of the effect of changes in the sizes and forms of ships upon economy of propulsion.

CHAPTER XIV.

THE STEERING OF SHIPS.

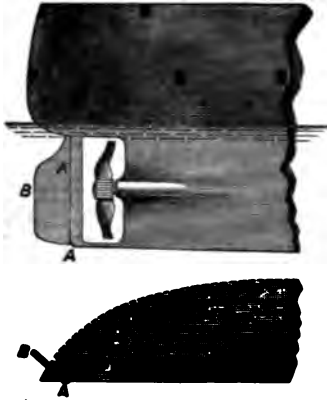
SHIPS are ordinarily manœuvred by means of rudders, sails, or propellers driven by steam-power. Steering by sail-power alone may be accomplished by the skilful seaman, if his ship has been well designed. Steering by the action of the propellers alone is also a possibility in certain classes of steamships, and this may be a great advantage under certain circumstances. Rudders are fitted, however, in all classes of ships, and form the most important means of controlling their movements under all ordinary conditions of service; so that in this chapter attention will be chiefly directed to the principles upon which the action of rudders depends. A brief notice will suffice respecting manœuvring by the use of propellers; but nothing will be said respecting manœuvring under sails alone, as that is peculiarly a matter of seamanship. The principal facts which concern the naval architect in arranging and distributing the sail spread of a ship have been already discussed in Chapter XII.

The rudder is almost always placed at the stern of a ship, which is the most advantageous position for controlling her movements when she has headway. In what follows it will be understood, therefore, that, unless the contrary should be stated, we are dealing with stern rudders. After discussing their action, a few remarks will be made respecting the use of bow rudders, auxiliary rudders, and other supplementary methods of increasing the turning power of ships.

Two kinds of rudders require to be noticed. First, the

ordinary rudder, which rotates about an axis near its foremost edge, and is hung to the sternpost of the ship. Fig. 127 shows the common arrangement in a single-screw ship.

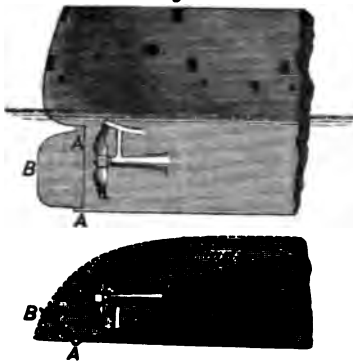
FIG. 127
Profile



is the *axis* of the rudder, the line passing through the centre of the pintles by which the rudder is hung to the after sternpost, or rudder-post. In the plan, AB represents the rudder put over to port, the helm being a-starboard.

In sailing ships, paddle-steamers, jet-propelled vessels, and twin-screw ships, the ordinary rudder is hung to the after end of the ship, there being only one sternpost in such vessels. Fig. 128 shows the

FIG. 128
Profile



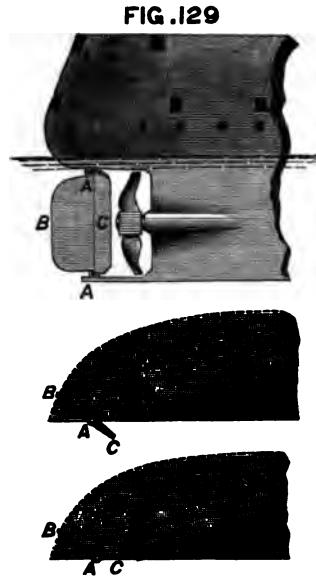
common arrangement in twin-screw ships; and, apart from the propellers, the drawing will also serve for the other classes named. A few ships have had the rudders placed before the single-screw propellers, but this is not a common plan; when it is adopted, the rudder is generally of the ordinary kind, and is placed in the after deadwood below the screw-shaft.

The second form to be noticed is the *balanced* rudder, which differs from the ordinary form in having a

part of its area—usually about one-third—before the axis about which it rotates. This kind of rudder has been used in many steamships of the mercantile marine and the Royal

Navy. Fig. 129 illustrates a common arrangement: AA is the axis. It will be observed that there is no rudder-post, the weight of the rudder being taken inboard, and the lower bearing at the after end of the keel being made use of simply to steady the rudder. In some

cases balanced rudders have been fitted without the lower bearing, the rudder-head being made exceptionally strong; but this plan has considerable disadvantages, especially as regards liability to derangement by shocks or blows of the sea. Usually the balanced rudder is made in one piece, and, when put over, occupies a position similar to that indicated (in plan) by Fig. 130, the part AC before the axis A being rigidly attached to the part AB abaft it. When the rudder is thus made in



one piece, it is termed a "simple" balanced rudder. Experience has shown, however, that, while it is advantageous when a vessel is under steam, to use the large area of the balanced rudder, it may be preferable, when she is under sail alone, to use a less area. To enable both these objects to be attained, the so-called "compound" balanced rudder has been devised; it is fitted in her Majesty's ships *Hercules* and *Sultan*, and has proved very satisfactory. The part before the axis is attached to a hollow annular head; up through which passes the rudder-head which carries the after part of the rudder; and the two parts are hinged to one another along the axis. When the ships are under steam, the two parts can be locked together and made to act as a simple balanced rudder; when the ships are under sail, the fore part of the rudder

can be locked fast in the line of the keel (as shown by AC, Fig. 131), occupying a position resembling that of the rudder-post in ordinary screw-steamers, and the after part alone (AB) is used to steer the ship.

Both ordinary and balanced rudders may be regarded simply as plane surfaces which, by means of suitable mechanism, can be placed at an angle with the keel-line. It is customary to speak of the "angle of helm" rather than the rudder angle. "Helm a-starboard" means that the rudder has been put over to *port*, and that the head of the ship moves to *port*. "Helm a-port" means that the rudder has been put over to *starboard*, and that the head of the ship moves to *starboard*. A sailing ship has "weather-helm" when the rudder has been put over to the leeward side, in order to make the head of the ship fall off from the wind. When the helm is "a-lee," the rudder has been put over to the windward side, in order to bring the head of the ship up to the wind.

In discussing the action of the rudder, it will be convenient to consider separately the following features:—

(1) The causes which produce, and govern the amount of, the pressure on the rudder, making it effective in turning a ship.

(2) The relation which exists between the pressure on the rudder and the force required at the tiller-end to hold the helm at any angle desired; as well as the work to be done in putting the helm over.

(3) The turning effect on a ship produced by the pressure on the rudder.

The first and second of these subdivisions are very closely connected; in discussing the third, it will be necessary to distinguish between, what may be termed, the *initial* motion of a ship when her helm is put over, and her subsequent motion when the speed of rotation has become approximately uniform.

When a rudder is placed obliquely to the keel-line of a ship, and streams of water impinge upon its surface in consequence of the motion of the ship, or the action of her

propeller, the motions of these streams must be more or less checked or diverted by the rudder, and the *change of momentum* thus produced reacts upon the rudder, causing a normal pressure upon its surface.* If the rudder were placed athwartships, and the streams were moving with uniform velocity parallel to the keel-line, they would impinge normally on the rudder, and the pressure upon it would resemble that experienced by the plane in Fig. 117, page 428. If the area of the immersed part of the rudder were S (square feet), and the velocity of the streams V (say, in feet per second), then the pressure P_1 on the rudder in its athwartship position might be expressed in the form—

$$P_1 = K \times S \times V^2,$$

where K is a constant quantity to be determined by experiment. Probably no error of a serious character would be involved in assuming the results obtained by Colonel Beaufoy for a submerged plane to hold in this case; and then K would equal 112 lbs. for a velocity (V) of 10 feet per second. The error involved would be one of defect, the actual pressure being somewhat greater than that experienced by a plane surface wholly submerged.

If this rudder, instead of being placed athwartships, were inclined at an angle a to the keel-line, it would sustain a less pressure; but experiments are wanting as to the exact law which governs the variation of the pressure in terms of the inclination. The old assumption was that, if P were the pressure for an angle a , and P_1 that for the athwartship position of the rudder, then

$$P = P_1 \sin^2 a.$$

This assumption is known, however, to be erroneous; in practice a does not exceed 40 degrees, and is often less than 20 degrees, so that it is probably more correct to assume as an approximate formula,

$$P = P_1 \sin a.$$

* See the remarks on reaction due to change of momentum on page 520.

Only a few observations are on record by which this approximate rule can be tested. One of the best series of experiments appears to have been that made with the *Warrior* some years ago, when the pressures on the tiller-end were measured by a dynamometer for different speeds of the ship and screw. The helm angle in this case was about 25 degrees, and on analysis the law of the sine appears to hold fairly well; but in making that analysis, it is difficult to make satisfactory allowance for friction of pintles, bearings, &c. Direct experiments on plane surfaces moved at different speeds and with various obliquities would be a far preferable mode of determining the law; and Mr. Froude has such experiments in contemplation.*

Although, in practice, the streams impinging upon a rudder do not move in lines parallel to the keel and with uniform velocity, yet the general principles explained above hold good. When a rudder is put over, the effective pressure upon it depends upon the relative speeds and directions with which the streams impinge upon it. In all classes of ships where the propellers are not placed at or near the stern, the motion of the water relatively to the stern of a ship moving ahead in a straight course will be of the character described in Chapter XI.; and as the rudder is attached to the ship and carried forward by it, the effective pressure will vary with the headway, the form of the stern, the roughness of the bottom, and the angle at which the rudder is placed. When

* Beaufoy and the French experimentalists whose results are mentioned at page 473 did not investigate the resistances of thin boards moved normally or obliquely, but limited their researches to the resistances of solids with wedge-shaped ends, the fineness of the angle of the wedge being varied. It may, however, be interesting to quote Beaufoy's results. At a speed of 8 miles per hour, a flat-ended body

experienced a resistance of 148½ lbs.; other bodies with wedge ends experienced resistances as under.

Angles of Incidence.	Resistances.	
	Actual.	By Law of Sine.
Degrees.	lbs.	lbs.
9½	30·7	24·7
14½	35·3	37
19½	41·7	49·4
30	51·4	74·1

a square stern causes "dead-water" to travel forward with a ship, and there is an eddying wake, a rudder placed in this water can experience little pressure, because the streams have but a small velocity relatively to the rudder. Chinese junks furnish a curious illustration of this condition, for it is said that the rudders commonly have to be lowered below the bottoms of the vessels in order to obtain pressure and steering power. On the other hand, fineness in the run increases the speed with which the streams approach the rudder, and the effective pressure due to reaction. The lowest part of the run, over the deadwood, is the finest, and here the velocity of approach of the streams is greatest, the effective pressure on the corresponding part of the rudder being proportionately increased. Further on the results of an experiment will be given, illustrating this statement.

In sailing ships, paddle-wheel vessels, and jet-propelled vessels, the effective rudder pressure may be regarded as mainly resulting from stream-line motions due to the headway. A sailing ship running dead before the wind would probably approach most closely to the assumed conditions. A ship sailing on a wind has leeway as well as headway, in addition to an angle of heel, all of which circumstances, as previously explained, would somewhat affect the stream-line motions; but probably the variations have no great influence upon the rudder pressure. In paddle-wheel vessels or vessels on the water-jet principle, the motion of the streams relatively to the rudder may also be somewhat affected by the action of the propellers. The velocities with which the streams approach the rudders, in vessels with fine sterns, are, however, commonly assumed to be proportional to the speeds of the vessels; and no error of importance is thus committed.

Similar considerations apply to the case where these classes of ships have sternway instead of headway; but in that case a rudder placed at the stern resembles in its action a bow rudder in a ship moving ahead. Instead of considering it in this connection, it will therefore be convenient to discuss the case hereafter jointly with that of bow rudders.

From the foregoing remarks it will appear that the rudder pressure which is effective for turning a ship has no connection with the hydrostatical pressure which would be acting upon the surface if the rudder were put over to any angle when the ship was at rest in still water. This distinction is mentioned because some persons have confused hydrostatical pressure, with the pressure or reaction due to the relative motion of the streams and the rudders, and have proposed to shape the rudder according to laws based upon this wrong assumption. The mistake made is similar to that referred to at page 428, as to the relative resistances of a plane surface wholly or partly submerged. There can be no question, however, that without motion of the ship, or of the water past the ship, the rudder can have no steering power. A ship or boat anchored in a tidal current or river can be turned, to some extent, from the line of flow of the current by the action of the rudder; because the water has motion relatively to the rudder. But without headway or sternway in still water, no ship can be under control by means of the rudder, unless she has her propeller placed in the neighbourhood of the rudder, and by its action can impel a current of water upon one of the surfaces of the rudder.

Screw steamers furnish illustrations of the last-mentioned condition. The propeller race is driven aft more or less directly upon the rudder when the vessel is moving ahead; and if she is moving steadily astern, the action of the propeller induces a forward pressure on the after surface of the rudder which is also effective for steering. Reference to Figs. 127-129 will show that this is almost equally true of single- and twin-screw ships. In fact, the common assumption, which experience justifies, is that the speeds of approach, as well as the directions of the streams impinging upon the rudder of a screw-steamer, are determined by the action of the propeller, rather than by the motion of the ship. Hence, so far as the action of the rudder is concerned, the form of the after part of a screw-ship is not so

influential as in sailing, paddle, or jet-propelled vessels; but it has been shown (at page 538) how important it is to have an extremely fine form of after body in order to secure the efficiency of screws.

The particles in the propeller race have rotary as well as sternward motion communicated to them, and therefore do not move parallel to the keel when they impinge upon the rudder, but in more or less spiral paths. In a single-screw ship, if the helm is put amidships, and the propeller made to revolve, the ship will be turned completely round under the action of the screw alone. Experience shows that, if the screw be "right-handed," the head of the ship will turn to starboard, if it be left-handed, she will turn to port, when the ship is driven ahead.* If the helm is left free, and the screw made to revolve, it is found that, when the ship moves ahead, the rudder will rest in a position inclined to the keel-line, and on that side towards which the particles of water in the race are driven by the lower blades of the propeller. The inference naturally is that the lower blades act upon less disturbed water than the upper blades, and deliver streams upon the lower part of the rudder which have more momentum than the streams delivered by the upper blades upon the other side of the upper part of the rudder. And the steering effect of the screw in one direction may be similarly explained by the excess of pressure produced upon the after sternpost and rudder by the streams delivered by the lower blades. This matter is not of great importance, its chief interest arising from the fact that single-screw steamers always turn more quickly to one side than to the other, when the helm angle is made equal in both cases. In twin-screw ships, right- and left-handed screws are fitted on

* Admiral Halsted expresses this somewhat differently, stating that the ship turns towards the side on which the screw *descends*. See his paper on "Screw-ship Steerage," in the *Transactions* of the

Institution of Naval Architects for 1864, which contains much interesting information as to steering trials made with the floating battery *Terror*.

opposite sides, so that there is no similar tendency to fall off from a course when the helm is amidships.

In this connection it may be interesting to mention the results of recent experiments made by Herr Schlick, on the screw-steamer *Vinodol*, in the port of Fiume. An ordinary rudder was divided into two equal parts, the line of section being horizontal. When the screw was at work, the lower half found its position of rest at an inclination of rather less than 10 degrees on one side of the keel-line, while the upper half rested at nearly an equal inclination on the other side of the keel-line.

Broadly speaking, it may be said that, when a screw-steamer is moving ahead, the velocity with which the streams impinge upon her rudder, if placed abaft the screw, equals the *speed of the screw*, and therefore equals the sum of the speed of the ship and slip of the screw. When the slip is considerable, as it may be in some cases (see page 530), the increase in rudder pressure and steering effect above that due to the headway of the ship may be a most valuable element in her handiness. Similar reasoning applies to the case where the propeller is driving a ship astern at a steady speed. But the most important case of screw-ship steerage is that when, to avoid a collision or any other danger, the engines of a screw-steamer are suddenly reversed, say, from full speed ahead to full speed astern. The vessel will then maintain headway for a short time, but the effect of the propeller race upon the rudder may more than counterbalance the effect of headway, and the vessel may steer as if she were moving astern, the resultant pressure being delivered upon the after surface of the rudder.

This feature of screw-ship steerage has long been known. An experiment was made with the *Great Britain* in 1845; and it was found that, when the vessel was going astern at the rate of 9 or 10 knots, if the engines were rapidly reversed, she steered immediately as if she were going ahead. Similar experience appears to have been gained with the *Archimedes* and other early screw-steamers. Attention has

been recently drawn to the matter by Professor Osborne Reynolds, more particularly with a view to furnishing ships' captains with rules for guidance in endeavouring to avoid collisions; and under the direction of a committee of the British Association, experiments are now being made. So far as the results have been published, they generally confirm those obtained in early screw-ships, and prove that the action of the propeller race may produce rudder pressure and steering power independently of the motion of ships ahead or astern. In twin-screw ships this power is less important than in single-screw ships, because the manœuvring power of the propellers alone is considerable.

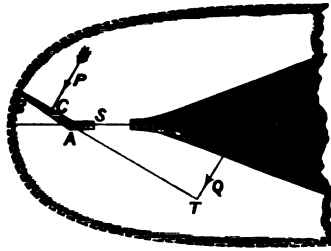
Summing up these remarks on the causes which govern the pressure on the rudders of different classes of ships, it may be said that in all cases that pressure depends upon the area of the immersed part of the rudder, the angle of its obliquity to the keel-line, and the speeds and directions with which the streams impinge upon its surface. The motions of the streams depend principally upon the motion ahead or astern, and the form of the after body in sailing, paddle, and jet-propelled ships, and upon the action of the propellers in screw-steamers. It must be added that, when ordinary rudders are employed, and hung either to a broad rudder-post abaft the screw, as in Fig. 127, or to the body of the ship, as in Fig. 128, the check put upon the motion of the streams by the rudder must produce a reaction and pressure not merely upon the rudder itself, but upon the portion of the stern-post or deadwood adjacent to the rudder. This additional pressure will be delivered on the side towards which the rudder is put over, and there is good reason for believing that it considerably assists the rudder pressure in steering a ship, being most valuable in cases where the rudder is hung to the body of the ship. With simple balanced rudders placed as in Fig. 130, there is no corresponding pressure on the deadwood, but instead of it a normal pressure on the additional rudder area placed before the axis. Compound

balanced rudders with the forward part locked fast (as in Fig. 131) of course resemble the case illustrated in Fig. 127 for an ordinary rudder.

Besides these normal pressures on the rudder, sternpost, and deadwood, there will be a certain amount of *frictional* resistance on the rudder surface when placed obliquely; but this is of little importance, as compared with the normal pressures, except for very small angles of helm: and, so far as it produces any effect on the steering, it will act against the normal pressures.

Next: reference must be made to the force required at the tiller-end to hold the rudder at any angle. This will, of course, depend upon the length of the tiller and the mode of

FIG.132



applying the force; but it may be assumed that both these conditions are given. In Fig. 132 an ordinary rudder is shown. The resultant pressure upon it is P , acting through the centre of effort C of the immersed rudder area. AT represents the tiller, Q the force required at its end, if applied normally to the tiller, in order to hold the rudder over. Apart from friction of the pintles, rudder bearings, collar, &c., we should have,

$$P \times AC = Q \times AT.$$

These frictional resistances vary considerably in different vessels, but may be made comparatively small by means of careful arrangements; in most cases they probably act with

the force Q in resisting the motion of the rudder back towards the keel-line. Neglecting friction, it appears therefore that, other things being fixed, the force at the tiller-end will vary with the distance AC of the centre of effort from the axis of the rudder. Formerly it was assumed that the centre of effort coincided with the centre of gravity of the immersed area of the rudder, and that the pressure due to the reaction of the streams was uniformly distributed over that area. Experience has proved this to be untrue when a rudder is set obliquely. In the case of balanced rudders, for example, it has been ascertained that, when the area before the axis was about one-half as great as the area abaft the axis, a dynamometer attached to the tiller-end indicated little or no strain, showing that the centre of effort of the rudder was then practically coincident with the axis. With ordinary rudders, in which the area is wholly abaft the axis, there is probably a similar excess of pressure on the forward part as compared with the after part; and the centre of effort lies considerably nearer to the axis than the centre of gravity of the immersed area. The explanation suggested by Mr. Froude of this experimental fact is simple and sufficient. When a plane is moved in a direction perpendicular to itself, in the manner illustrated by Fig. 117, page 428, a certain set of stream-line motions is established, and taken up by the particles contained in a column, which may be supposed to extend forward into the water perpendicularly to the plane. On the other hand, when the plane is moved obliquely, its leading edge, corresponding to the forward edge of a rudder, may be regarded as continually entering water which was comparatively little disturbed by the previous motion, and which therefore reacts more powerfully on that part of the area than does the water which impinges upon the after part of the plane, and which had been previously disturbed by the motion of the plane. As an approximate rule, probably no great error would be incurred in assuming the centre of effort in an ordinary rudder to be *one-third* or *one-fourth* of the mean breadth of the rudder from the

axis.* In a balanced rudder of the usual proportions, the centre of effort is nearly coincident with the axis. Consequently, with a properly balanced rudder of any required area, the power applied at the tiller-end has only to hold the rudder steady; whereas with an ordinary rudder of equal area at an equal angle it has to balance the very considerable moment of the pressure about the axis.

The *work* to be done in putting the balanced rudder over to any angle is simply that required to overcome the frictional resistances of the pintles, bearings, &c. of the rudder, and those of the steering gear proper, by which the power applied at the steering wheels is transmitted to the tiller-end. The waste work on friction of steering wheels, rods, chains, blocks, &c. may be very considerable; but with these we are not concerned at present. What may be termed the *useful work* done in putting the rudder over is that spent in overcoming the moment of the effective pressure corresponding to every position which the rudder can occupy between its midship position and its extreme angle.† In the case of the balanced rudder, this would be zero; in the ordinary rudder, using the previous notation, it would be represented approximately by the expression,

$$\text{Useful work} = P_1 \times AC (1 - \cos a) = P_1 \times AC \text{ vers } a,$$

where AC is the distance of the centre of effort from the axis, and is supposed to remain constant for all angles of the helm. This would represent the additional work required to be done by using an ordinary instead of a balanced rudder; and it might be of considerable amount when the helm angle was large.

Balanced rudders can be put over to large angles in a very short time with the same appliances as would require a

* Investigations on this subject are now being made by Lord Rayleigh and Mr. Froude, and considerable extensions of our present knowledge may be anticipated.

† The case is a parallel one to that for dynamical stability, explained at page 132; and it is unnecessary to repeat the explanation.

much longer time to put ordinary rudders over to moderate angles. This quickness of movement in the helm is of great importance, and it results from the conditions explained above.

The balanced type of rudder has been long known. Earl Stanhope proposed it in 1790; it was fitted to a ship by Captain Shulldham about thirty years later, and adopted in the *Great Britain* about 1845. It was not introduced into the Royal Navy until 1863, when the steering gear in use, worked by manual power, had failed to give satisfaction in the long swift ships of the *Warrior* class, and in many other screw-steamers of less size. The extreme angles of helm that could be reached did not exceed 18 to 25 degrees; and to secure even these results there was such a multiplication of tackles between the steering wheels and tillers as made the loss of power in friction very considerable, and the time of putting the helm over very long. On one occasion, for example, the *Black Prince* was turned in a circle with her rudder 30 degrees from the keel-line; to put the helm over occupied $1\frac{1}{2}$ minute, to complete the circle $8\frac{1}{2}$ minutes were taken, and forty men were engaged at the steering wheels and relieving tackles.* On another trial, the *Minotaur*, with eighteen men at the wheels and sixty at the relieving tackles, was turned in a circle in about $7\frac{2}{3}$ minutes, $1\frac{1}{2}$ minute being occupied in putting the helm over to the very moderate angle of 23 degrees. Balanced rudders enabled both these faults to be corrected, the helm being put up to angles of 35 degrees or 40 degrees very quickly, by the application of a very moderate force at the steering wheels. The *Bellerophon* was the first ship fitted on this principle; and on trial her rudder, which had an area about 25 per cent. greater than that of the *Minotaur*, was put over to an angle of

* For much interesting information on this subject, see a paper "On Steering Ships," by Mr. Barnaby, C.B. (Director of Naval

Construction), in the *Transactions* of the Institution of Naval Architects for 1863.

37 degrees in about 20 seconds by eight men, when the ship was steaming nearly at the same speed as the *Minotaur* had attained. The *Hercules* also, steaming at a higher speed than the *Minotaur*, had her larger rudder put over to 40 degrees in 32 seconds by sixteen men at the steering wheels, and completed a circle in 4 minutes. Further examples of the economy of power and rapidity of motion rendered possible by the balanced rudder will be found in the records of trials of her Majesty's ships.*

The introduction of steam and hydraulic steering apparatus has, however, restored the use of ordinary rudders in the largest screw-steamers of the Royal Navy. In vessels possessing sail-power as well as steam-power, it has been found that the balanced rudder, with its large area and facility of movement, might, unless carefully managed, cause ships to miss stays, or to fail in manœuvring under sail alone. The compound balanced rudder was devised to remove this objection, and has answered its intended purpose; but it is costly. Moreover, in all ships it is admitted that the ordinary rudder is less liable to serious damage, by striking the ground or other accidents, than the balanced rudder. When efficient apparatus had been devised by which the rudders of the largest vessels could be brought under the control of one man, and put over rapidly to any angle desired, there was every reason, therefore, to resume the use of ordinary rudders. And with twin-screw propellers these rudders possessed further advantages over the balanced type, in enabling the power of the screw race on either side to be utilised more efficiently. One example will suffice of the great advantages gained by using steam steering engines in large ships. The *Minotaur* is now fitted on this principle,

* A clever system of counter-balancing ordinary rudders by weights fitted within the ship was devised by Mr. Ruthven, whose name is so well known in connection with the jet propeller. For a

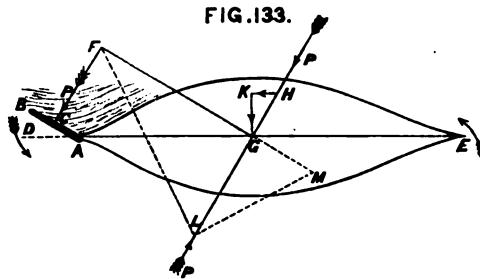
description of the plan, see vol. xi. of the *Transactions* of the Institution of Naval Architects. We are not aware that the plan has ever been adopted.

and on trial it was found that the rudder could be put over to 35 degrees in about 16 seconds by two men ; the circle was turned in about 5½ minutes, and its diameter was less than two-thirds as great as that on the former trial. Placing these figures beside those stated above, when manual power alone was used at the steering wheels, it will be seen how great has been the improvement made in this ship, of which the rudder remains unaltered ; and comparing the helm angle and time for putting the rudder over with the figures given for ships with balanced rudders, it will be seen that the ordinary rudder with steam steering is at no disadvantage.

In ships of war, steam steering gear has the further advantage of placing the control of the largest ships in the hands of one or two men, possibly in those of the commanding officer himself. To secure this advantage, such gear has been fitted in ships with balanced rudders, where the gain in manœuvring power has been comparatively small. Large merchant steamers are similarly fitted, the *Great Eastern* having been one of the first vessels furnished with a steering engine. A small auxiliary engine is now usually employed for the purpose, steam having been generally preferred to hydraulic power after numerous trials, although some arrangements on the hydraulic principle have given great satisfaction. Plans have been devised for taking power off the main screw-shafts in order to steer ships, but they have not found much favour ; and the arrangements now in use having proved thoroughly satisfactory, it is unlikely that the power of the main engines will be utilised for steering. The great majority of ships are still steered by manual power, and are likely to continue in that condition, their moderate sizes and speeds enabling ordinary appliances to put their helms over quickly to sufficiently large angles.

Thirdly : as to the effect of the rudder in turning a ship. This is the purpose for which the rudder is fitted, but the preceding remarks have been necessary in order to clear the way for the description that will now be attempted.

Suppose a ship to be advancing on a straight course with uniform speed when the rudder is first put over. Immediately there is developed a pressure on the rudder, the magnitude of which increases as the helm angle becomes larger. Fig. 133 shows the plan of a ship, with the rudder (AB) put over to the angle BAD; the arrow indicates the line of action of the resultant pressure P. Let G indicate a vertical axis passing through the centre of gravity of the ship; through G draw the line HL parallel to the line of action FC of the resultant pressure on the rudder, and along HL suppose two equal and opposite forces P, P to be applied. These forces will balance one another, and therefore will not



produce any change in the conditions to which the ship is subjected independently of them. By this means the single force P on the rudder is replaced by a single force P acting along HG, and a couple formed by the pressure P on the rudder and an equal force acting along LG; the arm of this couple is GF, and it evidently tends to turn the vessel in the direction indicated by the arrows at the bow and stern. The single force P acting along HG tends to produce a simultaneous motion of translation of the vessel along its line of action. This force P may be resolved into two components: if GH represents P, HK will be its component acting parallel to the keel, and KG the component acting perpendicularly to the keel. The transverse component is usually larger than the longitudinal; but it is not so important because at each instant it has opposed to it

the great force of *lateral resistance*,* and therefore can cause but a very small speed of drift. The longitudinal component, on the contrary, may exercise a sensible effect in checking the speed of a ship while she is turning. As the rudder is put over, the value as well as the direction of P change, and the absolute and relative values of these component forces will change; but at each instant conditions similar to those described will be in operation. It becomes important, therefore, to trace the consequent motion of the ship; and for the sake of simplicity it will be assumed that she is a steamer, the propelling force being delivered parallel to the keel-line.

Ultimately, when the rudder is hard over and held at a steady angle, the ship would be found to be turning in a path which would be very nearly a circle, and is usually treated as if it were a circle. Her speed would be somewhat less than it would be if she were steaming on a straight course with the same engine-power, and her ends would be turning about the vertical axis passing through the centre of gravity, with a nearly uniform motion, or angular velocity. Before this condition could have been reached, however, there must have been a period during which the angular velocity was gradually accelerated up to its uniform value, while the headway was being checked, and before the drift to leeward had supplied a resistance balancing the component of the rudder pressure and the centrifugal force. It will be well, therefore, to glance at this period of change before considering the case of uniform motion.

As soon as the rudder is put over, an unbalanced couple will be brought into operation, and the ship will begin to acquire angular velocity. At first this velocity will be very small; and as the resistance offered by the water to rotation varies very nearly as the *square* of the angular velocity,† that

* See page 482.

† The analyses which we have made from numerous turning trials of the *Warrior* enable us to state that in her case the resistance

varies with a power of the angular velocity almost identical with that deduced from the experiments made by Mr. Froude on frictional resistance.

resistance is of little importance in the earliest stages of the motion. The initial values of the angular acceleration will therefore chiefly depend upon the ratio which the moment of the couple bears to the moment of inertia of the ship about a vertical axis passing through the centre of gravity (G, in Fig. 133). That moment of inertia is determined by multiplying the weight of every part of the ship by the square of its distance from the axis of rotation; and the moment of inertia would evidently be much increased if heavy weights were carried near the extremities instead of being concentrated amidships. Hence, with a certain rudder area put over to the same angle in the same time, in two ships similar to another in outside form and immersion, but differing in their moments of inertia, the ship having the less moment of inertia will acquire angular velocity more quickly than her rival. Moreover, it will be evident that a ship of which the rudder can be put over quickly to its extreme angle will acquire angular velocity more rapidly than she would with the same rudder put over slowly. As the angular velocity is accelerated, the moment of the resistance increases, exercising an appreciable effect upon the acceleration; and finally a rate of motion is reached for which the moment of the resistance balances the moment of the couple due to the corresponding pressure on the rudder, the angular velocity then becoming constant.* It will, of course, be understood that, simultaneously with this acquisition of angular velocity, a retardation of headway will have taken place, and carried with it some change in the pressure on the rudder; the balance between the lateral resistance and the other forces named above will also have been established.

Four features, therefore, chiefly affect the readiness of a ship to *answer her helm*: (1) the time occupied in putting the helm hard over; (2) the rudder pressure corresponding to that position; (3) the moment of inertia of the ship about

* See the similar case previously illustrated for the effect of resistance to the oscillations of ships among waves; page 218.

the vertical axis passing through the centre of gravity; (4) the moment of the resistance to rotation. Only the first and second of these can be much influenced by the naval architect; their importance has already been illustrated from the turning trials of the *Minotaur*. The moment of inertia is principally governed by the longitudinal distribution of the weights in the ship; in arranging these weights, considerations of trim, convenience, and accommodation are paramount. The moment of resistance depends upon the form and size of the immersed part of the hull; and is especially influenced by the fine parts of the extremities. In some ships the deadwood forward and aft has been cut away considerably, in order to increase the handiness; but this practice is not common, and for sea-going and sailing ships it is open to the objection that it diminishes the lateral resistance and the resistance to rolling. Hence it rarely happens that a designer endeavours to exercise much control over the resistance to rotation; but in yachts and small craft the attempt is sometimes made.

Closely associated with this readiness to answer the helm, or to acquire angular velocity, are the conditions which control the decrease of that velocity when a vessel has had her head brought round to a new course upon which it is desired to keep her. The greater the ratio of the moment of resistance to the moment of inertia, the more rapid will be the rate of extinction of the rotation; and, conversely, the greater the ratio of the moment of inertia to the moment of resistance, the slower will be the rate of extinction. Both moment of inertia and moment of resistance must be considered; and possibly the helm would be brought into action to assist in keeping the ship on her new course. Deep draught, considerable length, fine entrance and run, and other features which lead to an increased resistance to rotation, are not, therefore, altogether disadvantageous. They make a vessel slower in acquiring angular velocity, but they enable her to be kept well under control. Shallow-draught vessels are not unfrequently less manageable by the helm than deep-

draught vessels; they quickly acquire angular velocity, and turn rapidly, but have comparatively small resistance in proportion to the moment of inertia, and are not easily kept on a new course, "steering wildly" in some cases, as a sailor would say. Vessels of the circular form possess great moment of inertia, whereas nearly the whole resistance to rotation must be due to skin friction, and can be but of moderate amount. It might, therefore, be expected that these vessels would be difficult to check and keep on any desired course if they had been turned through a considerable angle and required a good angular velocity. It has, in fact, been asserted that the vessels are "ungovernable" under the action of their rudders; and their designer, Admiral Popoff, in replying to these criticisms, dwelt upon the manœuvring power obtained by the unusual number of their propellers, not claiming for them great handiness under the action of the rudders alone.*

Experienced seamen declare that, when a steamer has headway, and the helm is put over, "the head appears to turn comparatively slowly while the stern swerves suddenly to "the right or the left."† This is quite in accordance with theoretical considerations. Professor Rankine many years ago published an investigation for the instantaneous axis about which a ship should begin to turn when the rudder was first put over, on the supposition that the first action of the rudder might be regarded as an *impulse*. His construction for this instantaneous axis is shown in Fig. 133. The length GL represents the "radius of gyration" of the ship about the vertical axis passing through the centre of gravity G; and is measured on the line HL drawn perpendicular to the arm FG of the couple.‡ Join FL, and produce FG to M; draw

* See a lecture delivered at Nicolaieff in 1875, of which a translation appeared in *Naval Science*.

† See an interesting article, "On Sternway," by Captain Allen, R.N.,

in *Naval Science* for 1875.

‡ See page 108 for an explanation of the term "radius of gyration."

ML perpendicular to FL, meeting FM in the point M; that point will be the "instantaneous axis" about which the *first* movement of the ship takes place, and M may lie considerably before the centre of gravity. To determine the instantaneous motion of any point in the ship, it is only necessary to join that point with M, and to describe a small circular arc with M as centre. It will be understood that this construction only applies to the motion of the ship at the *first moment* after the rudder is put over; and in practice the observation as to the comparatively slow motion of the head applies to the earliest movements. If the motion of rotation continues, it will become approximately uniform, and the centre of gravity will travel in a nearly circular path, as before remarked, the motion of rotation of the head and stern being nearly equal to one another.

Under these circumstances the forces acting upon a steamship would be as follows: (1) the propelling force delivered parallel to the line of keel; (2) the water pressure delivered perpendicularly to the surface of the rudder; (3) the centrifugal force, which may be considered to act at each instant along the radius of the circular path passing through the centre of gravity of the ship; (4) the resistance of the water to the motion of the ship. The propelling force and the centrifugal force act at each instant through the vertical axis passing through the centre of gravity of the ship, and, therefore, do not tend to produce rotation about that axis; but it is otherwise with the remaining forces. An explanation has already been given of the turning effect of the rudder pressure; and it is, therefore, only necessary to consider briefly that of the resistance. This is really the most difficult feature in the problem, and can only be dealt with here in general terms.

If any point is taken on the circular path which the centre of gravity of a ship traverses, the tangent at that point determines the instantaneous direction in which the ship as a whole would be moving when the centre of gravity occupies that position. The line drawn perpendicularly to the tangent determines the direction of the centrifugal force.

Adding to the centrifugal force the component of the rudder pressure which acts in the same direction, the sum will express the force which at that instant tends to make the vessel drift outwards from the centre of the circle. This force will be balanced by the "lateral resistance," it being understood that this lateral resistance differs from the resistance that would be experienced if the ship drifted broadside-on without headway or rotation. The motion of rotation constantly makes the bow of the ship turn inwards from the tangent to the circular path along which her centre of gravity is supposed to travel; and, as a consequence, there will be an accumulation of pressure on the outer (or lee) bow. It will in fact be seen, on consideration, that the circumstances at each instant are not unlike those described in a previous chapter for a ship sailing on a wind. The exact measure of this excess of pressure on the outer bow is a difficult matter; but of the existence of such an excess there can be no question. The line of action of the resultant pressure due to this excess and to the broadside drift will be situated before the centre of gravity; and the moment of the resultant about the centre of gravity will assist the moment of the rudder pressure in turning the ship. When the angular velocity has become constant, the sum of the moments of the rudder pressure and the lateral resistance will equal the moment of the resistance to rotation.*

Headway is, therefore, a considerable advantage to a ship in increasing the rapidity of her turning, not merely by

* It may be interesting to note in this connection a fact which Mr. Froude has brought to the knowledge of the Author. In the experiments on the resistance of models it has been found that, when the towing strain is delivered parallel to the line of the keel, the least disturbing cause will produce a departure from a perfect balance in the stream-line motions on either

side, and will make the models "slew" to one side or the other of their original course, unless means are taken to check the deviation. This illustrates the fact that even when a vessel is moving on a straight course, with the stream-line motions on either side perfectly symmetrical, their equilibrium is *unstable*.

making the water pressure on the rudder greater, but by adding to the turning moment of the lateral resistance. It will also be seen that, since the line of action of the lateral resistance is situated considerably before the centre of gravity, it is desirable to place the rudder as far aft of that line of action as may be convenient. In other words, the stern is the most advantageous position for the rudder when a ship is moving ahead. If she were moving astern, the conditions would be reversed, and the bow would be the best place for the rudder; and it is a matter of common experience that in "double-bowed" vessels, intended to steam in either direction, and fitted with a rudder at each end, the after rudder is usually employed and the fore rudder locked fast.

When ships are turning under the action of their rudders, they heel and change trim. Longitudinal inclinations arising from this cause are so small as to be of no practical importance, and frequently they are scarcely appreciable. Transverse inclinations are much greater than the longitudinal. The explanation of this heeling suggested by Euler and the early writers is very simple, but insufficient. In Fig. 133 the resultant pressure on the rudder was supposed to be delivered at the depth of the centre of gravity of the immersed area, the transverse component of that pressure acting at some distance below the centre of gravity of the ship. Let h be this distance, α the angle of helm, and P the normal pressure: then $P \cos \alpha$ is the transverse component of the pressure, and $P h \cos \alpha$ will be the moment to produce inclination. If W be the weight of the ship, m her metacentric height, and β the angle of inclination attained in turning, then, according to the old explanation,

$$P \cdot h \cdot \cos \alpha = W \cdot m \cdot \sin \beta.$$

This equation omits all consideration of the effect of the fluid resistance and centrifugal force; it could only hold approximately at the first instant, supposing the rudder to be put over very quickly, before the ship acquires any sensible

angular velocity. Moreover, in that case, the pressure on the rudder would be applied so suddenly that the inclination attained by the ship would almost certainly be greater in the early part of the motion than the value of β deduced from the above equation; and the case would be one to be dealt with by the method of dynamical rather than statical stability.* Little practical interest attaches to this part of the subject, and therefore it will not be followed out in more detail. The steady inclinations attained by ships in turning furnish conclusive evidence of the action of disturbing forces greatly exceeding in moment the transverse component of the rudder pressure: besides which the rudder pressure would tend to make ships heel inward, towards the centres of the circles in which they turn, whereas in practice ships commonly heel outwards. For example, ships weighing 8000 or 9000 tons, with metacentric heights of 3 or 4 feet, have been observed to heel 3 or 4 degrees in turning; and the most liberal estimate for the inclining effect of the rudder pressure, according to the above method, would not account for more than one-fourth of the observed inclination. The unequally distributed pressures due to the motion of the water relatively to the ship must, therefore, produce the transverse inclination. The force of lateral resistance described above is usually delivered below the centre of gravity, through which point the centrifugal force acts, and these two forces form an inclining couple. If in future trials of turning the circumstances noted should include careful record of the inclinations accompanying different speeds, helm angles, and times of turning, the subject may receive further elucidation.

Circle-turning trials are usually made with the ships of the Royal Navy, and with ships of war belonging to foreign navies; and from the results of these trials it is possible to

* See the remarks on the effect of suddenly applied forces, at page 135.

deduce some valuable principles and facts.* The following are a few of the most important :—

(1) The curve described by a steamship in turning differs very little from a circle if the evolution is performed in smooth water and light winds. Admiral Boutakoff asserts as the result of numerous experiments that the curve may for all practical purposes be treated as a circle, and that the lateral distance between the starting-point and the place of the ship when she has turned through 360 degrees rarely exceeds the breadth of the ship. M. Lewal, of the French navy, has drawn attention to the fact that the time occupied in putting the helm hard over, and that which the ship takes in acquiring uniform angular velocity, must affect the form of the earliest part of her path, and make it depart more or less from a circle.† The magnitude of the lateral resistance also affects the initial motion of the ship, because at the instant when the helm is put over the ship has a certain momentum in the direction of her advance, and this tends to make her continue moving in the same direction for a time. In shallow-draught ships this feature is most marked. As a matter of fact, the curve traversed appears to bring most ships a little within a true circle when they have turned completely round, and regained the course upon which they were steaming when the helm was put over.

(2) The diameter of the circle has been found to vary between six and eight times the length of the ship when ordinary rudders have been used in association with manual power only at the steering wheels. With manual power and balanced rudders, the diameter has been reduced to four or five times the length. With steam-steering or good hydraulic gear, and ordinary rudders, the diameter has been about four

* For much information respecting such trials, see Mr. Barnaby's paper "On Steering Ships," in the *Transactions* of the Institution of Naval Architects for 1863; Admiral Boutakoff's *Tactiques navales*,

and M. Dislère's *Marine cuirassée*.

† *Principes des Évolutions navales*; see also an able notice of this work in *Naval Science* for 1874.

times the length ; with steam-steering and balanced rudders, the diameter has fallen to less than three times the length in some cases, but in others reached nearly five times. These results have been obtained with large ships ; in small vessels, manual power applied to ordinary rudders commonly suffices to turn them in circles of which the diameter is only three or four times the length. It will be understood that in all cases the propellers are working full speed ahead when these results are obtained. As the speed is reduced, the diameter of the circle usually becomes smaller in ships with ordinary rudders and manual power at the steering wheels ; but with balanced rudders or steam steering, where there is no sensible difference in the times occupied in putting the helm hard over at the different speeds, there is, as a rule, comparatively little difference between the diameters of the circles turned at full and half-boiler power.

(3) The time occupied in putting the helm hard over exercises a considerable influence on both the time occupied in turning the circle and upon its diameter ; but more particularly affects the latter. As an illustration of this, the trials of the sister ships *Hercules* and *Sultan* may be cited. The latter has steam-power applied to her balanced rudder, which can be put over in about half the time occupied by the manual power in the *Hercules*. The diameter of the circle in the *Hercules* was nearly twice as great as that for the *Sultan* ; the time of turning for the *Sultan* was rather less than that for the *Hercules*, although the speed was half a knot less. It will be evident that the distance traversed by a ship in turning will depend upon the rapidity with which her uniform angular velocity is acquired, the rate of that velocity, and the check to her headway, all of which will be affected by the time occupied in putting the helm up. By means of balanced rudders or steam steering, the mean angular velocity, or speed with which the ends of a ship turn relatively to the middle, has in some cases been almost doubled as compared with the results obtained with ordinary rudders and manual power.

(4) Other things remaining unchanged, an increase in the rudder area is most influential in diminishing the space traversed in turning; and this diminution may be of the greatest value to a war-ship intended to act as a ram. This point has been illustrated by the performances of the *Sultan* and *Hercules* with their rudders acting as simple balanced rudders, and with the after parts of the rudder alone at work. Further it appears that increased rudder area and helm angle may, in some cases, check the headway so much as to produce no greater turning effect than, if so great as, would be produced by smaller rudders and less helm angles. In his experiment on the gunboat *Delight* with balanced rudders of different sizes, Admiral Sir Cooper Key found that the largest rudders diminished the space traversed in turning, made the time of turning the first quadrant less (that is, enabled the full angular velocity to be more quickly attained), but somewhat increased the time of completing the circle, in consequence of the greater check to the headway.

(5) For the same ship, with the same angle of helm and about the same time occupied in putting the helm over, the time occupied in turning the circle appears to vary nearly inversely as the speed. Take, for example, the following published results for the *Warrior* and *Hercules* :—

<i>Warrior.</i>				<i>Hercules.</i>			
Speeds.	Times of Turning Circle.		Products of Speeds by Times.	Speeds.	Times of Turning Circle.		Products of Speeds by Times.
Knots.	Min.	Sec.		Knots.	Min.	Sec.	
3	28	46	86·3	6	9	32	57·2
6	15	30	93	8	7	21	58·8
9	10	40	96	10	6	22	63·6
12	8	45	105	12½	4	28	54·2
14½	7	21	104·1	14·7	4	0	58·8

This rule may be of some service in approximating to the time that will be occupied in turning at any selected speed when the performance at some other speed is known.

(6) Up to helm angles of 40 degrees, the turning power of the rudder has been found to increase with increase in the helm angle. Theoretically, if the streams impinged upon the rudder parallel to the keel-line, and the effective pressure on the rudder varied with the sine of the angle of inclination, 45 degrees would be the angle of maximum turning effect. This may be seen very easily. Using the notation of page 571, the moment of the pressure (P) on the rudder will vary very nearly as the product $P \times GA \cos a$ (Fig. 133); the distance AC from the axis to the centre of effort of the rudder being very small as compared with AG. Hence, approximately,

$$\begin{aligned} \left. \begin{array}{l} \text{Moment of pressure on} \\ \text{rudder about G} \end{array} \right\} &= P \times GA \cos a \\ &= P_1 \sin a \times GA \cos a \\ &= \frac{1}{2} P_1 \sin 2a \, GA. \end{aligned}$$

This will have its maximum value when $\sin 2a = 1$ and $a = 45$ degrees. Balanced rudders are usually arranged so that they can be put over to 40 degrees; ordinary rudders are seldom put over beyond 35 degrees, and with manual power only, the angle seldom exceeds 25 degrees in large screw-steamers.

When manual power only is used, as in the great majority of ships, it becomes important, with ordinary rudders, to decide between the relative advantages of the area and helm-angle which are possible with a certain power available at the tiller-end. Mr. Barnes (Surveyor of Dockyards) drew attention to this matter some years ago, basing his investigation on the old law, that the effective pressure on the rudder varied as the *square* of the sine of the angle of inclination.* Adopting the law of the sine, it may be interesting to make a similar comparison between a narrow rudder held at a certain angle by a given force at the tiller-

* See his paper in the *Transactions* of the Institution of Naval Architects for 1864.

end, and a broader rudder of equal depth held at a smaller angle by the same force. Let it be supposed that the rudders are of similar form; so that their areas and the distances of their centres of effort (C, Fig. 132) from the axis will be proportional to the extreme breadths, B_1 and B_2 . Then for the narrow rudder we may write,

$$\text{Area of rudder} = S_1 = \text{depth of rudder} \times B_1 \times f = f \cdot d \cdot B_1,$$

where f is some fraction of the breadth applicable to both rudders. Using the notation previously adopted, a_1 being the helm-angle,

$$\begin{aligned} \text{Pressure on rudder} &= K \cdot S_1 \cdot V^2 \sin a_1 \\ &= K \cdot fd \cdot V^2 \cdot B_1 \sin a_1 = C_1 \cdot B_1 \sin a_1. \end{aligned}$$

$$\left. \begin{array}{l} \text{Moment of pressure about} \\ \text{axis of rudder} \end{array} \right\} = \begin{cases} \text{pressure} \times \text{AC} \\ = C_1 B_1 \sin a_1 \times r \cdot B_1 \\ = r C_1 \times B_1^2 \sin a_1. \end{cases}$$

If S_2 be the area of the broad rudder, a_2 its angle, B_2 its breadth, similar expressions will hold for it, the constants C_1 and r being identical. Hence, in order that the moments of pressure about the axes of the rudders may be equal, we must have,

$$C_1 r \cdot B_1^2 \sin a_1 = C_1 r \cdot B_2^2 \sin a_2$$

whence,
$$\frac{\sin a_1}{\sin a_2} = \frac{B_2^2}{B_1^2}.$$

The last equation succinctly expresses the relation which must hold when the force applied at the tiller-end is the same in both cases.

For the turning effect of either rudder, we may take

$$\text{Turning effect} = \text{pressure} \times \text{AG} \times \cos \text{ of helm-angle};$$

and, since AG is the same for both rudders,

$$\frac{\text{Turning effect of narrow rudder}}{\text{Turning effect of broad rudder}} = \frac{B_1 \sin a_1 \cos a_1}{B_2 \sin a_2 \cos a_2} = \frac{B_2 \cos a_1}{B_1 \cos a_2}.$$

Suppose, as an example, the narrow rudder put over to 40

degrees and the broad to 20 degrees by the same force on the tiller-end :

$$B_2 = B_1 \sqrt{\frac{\sin 40^\circ}{\sin 20^\circ}} = B_1 \sqrt{\frac{0.643}{0.342}} = 1.37 B_1.$$

$$\begin{aligned} \frac{\text{Turning effect of narrow rudder}}{\text{Turning effect of broad rudder}} &= 1.37 \frac{\cos 40^\circ}{\cos 20^\circ} \\ &= 1.37 \times \frac{0.766}{0.94} = 1\frac{1}{3} \text{ (nearly).} \end{aligned}$$

The broad rudder, with an area 37 per cent. greater than the narrow one, has therefore less turning effect by about 11 per cent. If the ship had sail-power as well as steam, the smaller area of the narrow rudder would have the further advantage of checking the headway less when the ship was manœuvring under sail alone.

Various rules have been used for determining the *area* of the rudder for a new ship. For sailing ships of former types, having lengths about $3\frac{1}{2}$ to 4 times the beam, the extreme breadth of the rudder was commonly made *one-thirtieth* of the length, or *one-eighth* of the breadth of the ship. The mean breadth of a rudder commonly varied between seven-tenths and nine-tenths of the extreme breadth. For steamships a similar rule is used, the extreme breadth of the rudder being made from *one-fortieth* to *one-sixtieth* of the length. Mr. Scott Russell has proposed to make a slight modification of this rule, the extreme breadth of the rudder being one-fiftieth of the length *plus* 1 foot. Another mode, commonly used for English and foreign ships of war, is that by which the area of the immersed part of the rudder is proportioned to the area of that part of the longitudinal middle-line section of the ship situated below the load-line; the same area which is made use of in determining the "centre of lateral resistance" for sailing ships (see page 482). As the area of this section depends upon the product of the length of the ship into the mean draught, while the rudder area depends upon

the product of its breadth into the draught of water aft, it will be seen that this rule agrees in principle with the old rule. In sailing ships, the rudder area was often about *one-thirtieth* or *one-fortieth* of the area of the middle-line plane; in the screw line-of-battle ships and frigates, similar values were common; from *one-fortieth* to *one-fiftieth* are common values in ironclad ships of moderate length with ordinary rudders. In the long ironclads of the *Warrior* and *Minotaur* classes, the rudder area varies between *one-fiftieth* and *one-sixtieth* of the area of the middle-line plane; whereas in the ironclads fitted with balanced rudders it rises to *one-thirtieth*, and in some recent types in the French navy and in the Russian circular ironclads has been made *one-twentieth*. *One-fortieth* would probably be a fair average for steamships of war.

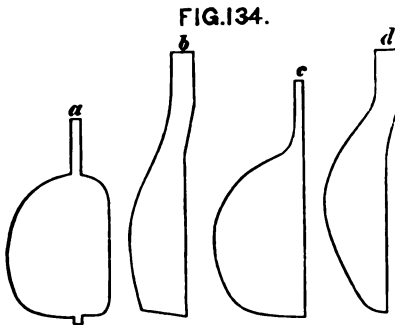
None of these rules can be regarded as entirely satisfactory; because they take no cognisance of the law of variation of the resistance to rotation. When the angular velocity has become constant, that resistance varies nearly as the square of the angular velocity; and the moment of the pressure on the rudder should be proportioned thereto. In fact, it appears on investigation that the pressure on the rudder, which—other things being equal—depends upon the rudder area, should in similar ships vary, not with the area of the middle-line plane, but with the product of that area into the square of the length, if the speed of turning is to be equal, after the motion has become uniform. If regard is had to the initial motions of the ships under the action of their rudders, the moments of the pressure on the rudder should be made proportional to the moments of inertia of the ships. In other words, the products of the rudder areas into the lengths of similar ships should be proportional to the moments of inertia, which will involve the product of the displacements into the squares of the lengths. The displacements will vary as the cubes of the lengths; the moments of inertia will therefore vary as the fifth powers; the area of the middle-line plane will vary as the square; and therefore, under this mode of viewing the question, the rudder areas should be propor-

tional to the products of the areas of the middle-line planes into the squares of the lengths. Expressed algebraically, if A_1 and A_2 are the areas of the middle-line planes of two similar ships; a_1 and a_2 the rudder areas; l_1 and l_2 the lengths: the rule would be,

$$\frac{a_1}{a_2} = \frac{A_1}{A_2} \left(\frac{l_1}{l_2} \right)^2$$

This would give a much larger area to the rudders of long ships than is commonly adopted; and, as a matter of fact, long ships usually turn more slowly than short ships in consequence of their proportionately small rudders.

Great differences of opinion have been expressed respecting the best *form* for rudders. In Fig. 134 a few of the commoner forms are illustrated.



The balanced rudder *a* has been previously described; *b* is a form much in vogue for the older classes of sailing ships and unarmoured screw-ships of the Royal Navy, the broader part being near the heel of the rudder,

and the narrower part near the water-line; *c* is a form now commonly used in the steamships of the Royal Navy; *d* is the opposite extreme to *b*, the broadest part of the rudder being placed near the water-line: this form is much favoured in the mercantile marine, especially for sailing ships, and is recommended on the ground that the lower part of a rudder is less useful than the upper part; but this is a misconception of the real facts of the case. From the remarks made on page 573 as to the unequal motion of the currents in the wake of a ship, it appears that the fineness of the run near the keel should make the lower part of the rudder the most effective; and this has been

verified experimentally.* Hence it seems probable that, with the form of rudder *d*, the narrower, lower part does quite as much work in steering as the broader, upper part: whereas, by tapering the rudder, the power required to put the helm over is made considerably less than it would be if the breadth were uniform. These considerations would not have equal force in screw-steamers where the rudder is placed abaft the screws; and then the form *c* is to be preferred, as the broadest part of the rudder is much less likely to be emerged by pitching than with the form *d*. In some vessels, to obtain greater command over their movements, the keel has been deepened aft, and the rudder thus made to extend below the body of the ship into less disturbed water. The case of the Chinese junks previously mentioned also bears out the advantages obtained by placing rudders in water which has a maximum sternward velocity relatively to a ship. In the floating batteries built during the Russian war, "drop-pieces" were fitted at the bottom of the rudder, and hinged to the heel, so that, when the rudder was put over, they might drop down below the keel and increase the steerage. The results in this case were not entirely satisfactory, but the circumstances of these vessels were peculiar.

A few special forms of rudders may be mentioned before passing on.

One proposed by Professor Rankine some years ago for screw-steamers was to be on the balanced principle, but to have curved sides, in order that the propeller race in passing might communicate a pressure which should have a forward component and help the ship ahead to a small extent.

Quite recently, Herr Schlick has proposed a very similar

* See the account of an experiment made by Mr. Froude, cited by Dr. Woolley, in a paper "On Steering Ships," read at the British Association in 1875. A model was fitted with a rudder of uniform

breadth, divided into two equal parts at the middle of the depth, and the lower half, when fixed at 10 degrees only, balanced the upper half fixed at 20 degrees when the model was towed ahead.

rudder, the surface of which is to be twisted, so that the currents driven obliquely from the screw-propeller may move freely past the rudder when it is amidships, and not impinge upon its surface as they do upon that of an ordinary rudder. By this change it is supposed that two advantages will be gained: (1) there will be little or no check to the headway of a ship when the helm is amidships; (2) steering power will be obtained from all parts of the rudder surface immediately the helm is put over to either side, whereas with plane-surfaced rudders, placed behind screw-propellers, this is not the case. Experiments made at Fiume with small vessels are said to have demonstrated the great superiority of the new rudder in both these particulars; and its more extended use is regarded as certain.*

Another special form is the Joessel rudder, first introduced into the French navy, favourably reported upon after trial in several ships, and now about to be tried in a few ships of the Royal Navy. This rudder is usually made on the balanced principle; but instead of being formed in one solid blade, as in Fig. 130, it consists of two or three blades set parallel to one another, and turning about one axis. The streams of water can pass between the parallel blades, and the additional surface upon which the water can operate is said to sensibly increase the useful effect of the rudder. In these rudders the joint area of the parts of the blades situated before the axis is said not to exceed *one-fourth* the joint area of the parts abaft the axis.

Another special rudder is that patented by Mr. Gumpel. It is a balanced rudder as to suspension, but it is carried on crank-arms; and the fore edge has attached to it a vertical pintle, which works freely in a fore-and-aft slot cut in the counter of the ship. When the helm is put over, therefore, the fore edge of the rudder is constrained to remain at the middle line, the rudder being moved bodily over to one side

* See an account of the experiments in the *Revue maritime* for April 1877.

of the keel by means of its crank-arms. It is asserted that the force required at the tiller-end to hold the rudder at any angle is less than that for an ordinary rudder; and the crank-arms can be so proportioned that, when the rudder is hard over, little or no force is required at the tiller to hold it there. Mr. Gumpel has tried the rudder in a small steam yacht with great success; but it has not been tested on a large scale. The plan is an ingenious one, but now that balanced rudders are giving way to ordinary rudders moved by steam-power, there is not much probability that trials will be made; and there are obviously greater risks of damage and derangement with this rudder than with simple balanced rudders.

Mr. Lumley proposed to make ordinary rudders in two parts, hinging the after part to the fore part, which was attached, in the usual way, to the sternpost. When the helm was put over to any angle, it moved the fore part of the rudder through an equal angle; but the after part was made to move over to a greater angle by means of a simple arrangement of chains or rods, and thus a greater pressure on the rudder was obtained. Several ships were fitted on this plan, and it was favourably reported upon in some cases, but has now fallen into disuse, at least in the Royal Navy, the principal reason probably being that the apparatus for working the after part of the rudder was liable to derangement.

Of the *auxiliary appliances* fitted to increase the steering power of ships, the most important are *bow rudders*. These rudders are rarely fitted except in vessels which are required to steam with either end foremost; either to avoid the necessity for turning, or to be capable of service in rivers or narrow waters where there is little room for turning, or to meet some other special requirement. In nearly all cases, moreover, arrangements are made by which such rudders can be locked fast in their amidship position when the ship is steaming ahead. Few ships of the Royal Navy are thus fitted. The jet-propelled *Waterwitch*, intended to steam

indifferently with either end foremost, is, we believe, the largest ship of war fitted with a bow rudder; but many coast-defence and river-service gunboats have bow rudders which are used when steaming astern. The cable-ship *Faraday* also had two rudders, but only to facilitate her manœuvring when moving astern, in which case the stern rudder was usually locked in its amidship position. Many double-bowed passenger steamers for river service are similarly fitted, the after rudder only being used at any time.

Before balanced rudders and mechanical steering gear had increased the speed of turning for large ships, the desirability of using bow rudders in association with stern rudders was considered; but the plan was not adopted. It has been again and again revived since that time, but seldom favourably received. Several obvious objections to fitting bow rudders which should be used when going ahead will at once occur to the reader. First, and very important in a war-ship, it would be far more liable to damage or derangement from collision or blows of the sea than a stern rudder. Further, a bow rudder of moderate size put over to a good angle must cause a considerable increase of resistance and disturbance of the flow of water relatively to the ship. It must also be a matter of some difficulty to secure efficient simultaneous action of two rudders placed at the extremities of a large ship. Bow rudders are usually hinged at the after edge to the body of the ship; and consequently when they are put over, to any angle, in a ship moving ahead, there must be an accumulation of pressure on the fine part of the bow abaft the rudder, on the side to which the rudder is put over. This additional pressure resembles that previously described (see page 577) as acting on the deadwood or sternpost before an ordinary stern rudder: only in that case it was shown to act *with* the rudder pressure in turning the ship, whereas at the bow the additional pressure acts *against* the rudder pressure, and diminishes its turning effect. If bow rudders have to be used, it is therefore advantageous to make them on the balanced principle; the streams flowing past the

back of the rudder when it is put over need not then impinge so directly upon the hull, and cause a loss of rudder power.

Steering screws have also been suggested as a means of considerably increasing the speed of turning, or of enabling a single-screw steamship to turn without headway. The principle of most of these proposals is to fit a screw of moderate size in the deadwood either forward or aft, in such a manner that, when set in motion by suitable mechanism, its thrust shall be delivered at right angles to the keel-line. Small manœuvring screws, driven by manual power, had been previously proposed and tried in sailing ships; but Mr. Barnaby, we believe, first suggested the use of similar and larger screws, driven by steam-power, for the *Warrior* and *Minotaur* classes of the Royal Navy: proposing to fit the steering screws at the bows of these ships, in apertures cut in the deadwood for the purpose.* Subsequently the Astronomer Royal, Sir George Airy, proposed a similar screw, but suggested that it should be placed in the after deadwood, below the main propeller shaft. Other proposals of a similar character have also been made; but we are unaware of any trials having been made on actual ships. There can be no doubt as to the manœuvring power that might thus be obtained; but considerable practical difficulties would have to be overcome in carrying the plan into practice and communicating driving power to the steering screws.

A special form of steering screw proposed by Herr Lutschauin deserves to be mentioned.† It consists of a small screw carried by the rudder, and put over by the helm to the same angle as the rudder. By means of a simple train of mechanism the steering screw is made to revolve by the motion of the main propeller shaft; and its thrust is always delivered at an angle with the keel when the rudder is put over. Such a screw would undoubtedly give considerable

* See the *Transactions* of the Institution of Naval Architects for 1863 and 1864. Trials have also been made with water-jets expelled athwartships from orifices near the bow and stern: but with no great gain of manœuvring power.

† See the *Transactions* for 1874.

steering power if suitably arranged for its position in the race of the main propeller; but the mechanism would be liable to derangement, and damage to it might interfere seriously with the efficiency of the main screw-propeller.

Professor Rankine mentions the case of a twin passenger steamer, the *Alliance*, designed by Mr. George Wills, in which manœuvring paddle-wheels were fitted at the bow and stern, the axes of the wheels lying fore and aft, and their thrust being delivered athwartships. No reports of the performances of this vessel are recorded.

Auxiliary rudders of various kinds have been tried, but none have proved so successful as to pass beyond the experimental stage, or to be used apart from the special circumstances for which they were devised. In some of the floating batteries built during the Crimean War, in which the shallow draught and peculiar form made steering very difficult, auxiliary rudders were fitted on each side at some distance before the stern, and arranged so that they could be put over to an angle of about 60 degrees. No sensible improvement in the steering appears to have resulted from these additions. Another form of auxiliary rudder was proposed by Mr. Mulley, and tried at Plymouth in 1863. It consisted of a rudder fitted on each side of the after deadwood, at a short distance before the screw aperture; it was hinged at the fore edge, and, when not in use, could be hauled up close against the side, but, when required, could be put over to 38 degrees from the keel-line. When applied to a paddle-wheel tug, it answered admirably, steering her by its sole action, and making her turn more rapidly when acting in conjunction with the main rudder. It completely failed, however, when tried on her Majesty's screw-ship *Cordelia*, and produced a distinct turning effect on the ship in the direction opposite to that in which it was expected to act. The explanation of the failure suggested by the inventor is probably correct: the action of the screw-propeller may have produced a negative pressure on the side of the deadwood abaft the auxiliary rudder when it was put over; and

the turning effect of the negative pressure more than counterbalanced the effect of the auxiliary rudder. Possibly, if the latter had been placed further before the screw, it might have succeeded, as it did in the paddle-wheel vessel.

One of the most recent trials of auxiliary rudders made in the Royal Navy is that carried out in the *Sultan*. She was fitted with sliding rudders, one on each side, arranged so as to counterbalance one another; when one was allowed to project under the counter, the other was drawn up into a casing within the ship; and both could be "housed" when desired. The area of each of the auxiliaries, when fully immersed, was about *one-sixth* of the area of the main balanced rudder; and it was set about 50 degrees from the keel-line. On trial it was found that the small area of the auxiliary rudder rendered its steering effect so small as to be practically unimportant.

Steering blades or boards somewhat similar in principle to those tried in the *Sultan* have been used successfully in vessels designed for shallow-water service. These blades were set at an angle of about 45 degrees from the keel-line on either side, and could be pushed aft from the stern or dropped down into the water on the side towards which the head of the ship was to be turned. The idea is an old one, and has, we believe, been made use of on some occasions to steer sea-going ships which have lost their main rudders.

Of the very numerous plans of "jury rudders" which have been proposed, we can say nothing in the space at our disposal. They are all based upon the principles explained above for the ordinary rudder, and are more or less satisfactory expedients for taking the place of the rudder properly belonging to any ship.

In conclusion, a few remarks must be made respecting the steering of ships by means of their propellers. This power may be said to be limited to twin-screw ships, paddle-wheel steamers in which the wheels can be disconnected, and vessels fitted with water-jet propellers, or with the "Fowler"

steering propeller. Ships with single screws will, as already described, complete a circle to one side or the other with helm amidships; but the turning will be performed very slowly, the circle will be of large diameter, and the commanding officer has no power over the motion, except by using the rudder. Plans have been proposed and tried for remedying this defect of the single screw, but none has proved successful. One of the most promising was that proposed by Mr. Curtis, in which the screw was attached to the shaft by means of a suitable joint, and was carried by a frame hinged like a rudder to the stern. The frame, carrying the propeller, could be put over with the helm to any angle desired; and the thrust of the screw, driven by the main engines, was then delivered at an angle with the keel-line, exercising a powerful turning effect on the ship. On trial it was found that this turning effect was very powerful indeed, and the motions of the small vessel so fitted were very rapid; but there was far less control over the motion than with the rudder, and this fact, together with the difficulties and risk of derangement to the propelling apparatus which would attend the adoption of the plan on a large scale, has prevented its use.

The Fowler propeller, fitted in the American torpedo-vessel *Alarm*, and in a few small vessels, consists of a feathering paddle-wheel placed at the stern, the axis of the wheel being vertical. By means of suitable mechanism the paddle-floats can be made to "feather" at any point in their revolution; and in this way the maximum thrust can be delivered in different directions, and made either to propel the vessel ahead or astern, or to steer her on any desired course. The apparatus is said to answer well in the *Alarm*, as regards handiness; but it is still in the experimental stage.

The other propellers named, being in duplicate, deliver their thrusts independently on either side of a ship and at some distance out from the middle line. It is possible, therefore, to make one propeller deliver its thrust ahead and the other astern, when the ship will turn on her centre

without headway; or to use only one propeller, when she will turn and describe a circle of more or less considerable diameter; or to use the rudder in association with either of these conditions in order to increase the speed of turning or lessen the space traversed. The principle is the same for all three propellers, but the distance between the lines of thrust of twin-screws is commonly less than *one-half* the extreme breadth of a ship, whereas, with disconnecting paddles, the corresponding distance would commonly be *four-thirds* the extreme breadth; and with water-jets the distance somewhat exceeds the breadth. Notwithstanding this advantage, twin-screws compared favourably with water-jets on the only occasion on which we know their turning powers to have been tried in competition. No similar competitive trials appear to have been made with twin-screws and disconnecting paddles; but the restricted use of paddle-wheels makes it unnecessary to inquire into their relative merits.

Turning trials with twin-screw vessels have established the following conclusions:—

(1) That with *ordinary* rudders such vessels can be steered as efficiently as single-screw ships when both screws are working full speed ahead. Balanced rudders applied to twin-screw ships have not always been so successful as in single-screw ships; but this partial failure probably arose from the fore-and-aft position of the twin-screws, as in other cases better performances have been obtained with twin-screw ships fitted with balanced rudders than with sister ships fitted with ordinary rudders. For example, the *Iron Duke*, with twin-screws and an ordinary rudder, occupied about 4 minutes 38 seconds in turning a circle 505 yards in diameter; her sister ships, the *Audacious* and *Invincible*, with balanced rudders, occupied about $4\frac{1}{2}$ minutes, and turned in circles having diameters of about 400 and 325 yards respectively. Compare with these the performances of the *Resistance*, a single-screw ship of the same length and displacement, with an ordinary rudder; she occupied $6\frac{1}{2}$ minutes in turning a circle 600 yards in diameter, and although her

lower speed would account for some part of the slowness of turning, her performance, on the whole, was distinctly inferior to that of the twin-screw ships.

(2) That with helm amidships, one screw working full speed ahead and the other full speed astern, such vessels can be turned upon their own centres, but the time of turning is considerably greater than when both screws are working ahead and the rudder is used.

(3) That when the screws are working in opposite directions, as in the preceding case, if the helm is put over, the time of turning is usually greater than when both screws are working ahead and the rudder is used; but the vessels turn nearly upon their centres. For example, the *Captain* took 5 minutes 24 seconds to complete a circle of 750 yards diameter with both screws full speed ahead and helm hard over; as against 6 minutes 52 seconds in the other condition, when she turned nearly on her centre. The explanation of the difference is to be found in the lack of the turning effect of the resistance on the outer bow and in the diminished efficiency of the rudder produced by the absence of headway, as well as by the action of the screw which is working full speed astern on the side towards which the rudder is put over. It is worthy of remark, however, that the rudder does some work under these circumstances; for the time of turning has been found to be less than when the same vessel was turned by the action of the screws alone. Mr. Barnaby gives a case where the times for the two conditions were respectively $4\frac{1}{4}$ minutes and 6 minutes 55 seconds. A possible explanation of this circumstance may be found in the turning effect of the accumulated pressure that will act on the side of the deadwood before the rudder, and will assist the screws in turning the ship.

(4) That when one screw is stopped and the other worked full speed ahead, with the rudder hard over, vessels can be turned somewhat more slowly than when both screws are working ahead. As to the relative diameters of the circles described under these two conditions, there is less agreement.

Mr. Barnaby gives a case where a twin-screw ship completed the circle in 3 minutes 48 seconds with both screws working ahead ; and in 3 minutes 58 seconds with one screw stopped ; the diameter of the circle in the latter case being one-third less than in the former. In the *Captain*, the corresponding results were 5 minutes.24 seconds to complete a circle 750 yards in diameter when both screws were worked ahead, and 7 minutes 50 seconds to complete a circle 874 yards in diameter when one screw was stopped.

(5) That with one screw only at work and the helm amidships, the ship can be turned completely round, but the time of turning is considerable, and the diameter of the circle large as compared with the other modes of turning. In the *Captain*, about $9\frac{3}{4}$ minutes were occupied in turning a circle nearly 1100 yards in diameter. Even this turning power might be of service, however, to a vessel of which the rudder and one screw had been damaged.

It is usual in twin-screw ships to place the shafts parallel to one another and to the keel ; but more than once it has been suggested that advantage in steering might result from making shafts diverge from one another, in order to increase the leverage of the thrust of either propeller about the centre of gravity. This plan has been applied in the *Faraday*, a ship built for the special purpose of laying submarine telegraph cables, and therefore requiring great handiness under all conditions of wind and sea. It is said to have proved very successful ; and her owner, Dr. Siemens, states that, with the rudder locked amidships, some of the most delicate operations connected in laying and splicing cables were performed in a rough sea and strong wind, the ship being manœuvred by the screws alone. The shafts in this vessel diverge from parallelism with the keel-line by being at a greater distance from it at their fore ends than at the after ends ; abreast of the centre of gravity the distance between the shaft lines is about 40 feet, near the propellers the distance is about half as great. Another interesting fact in the management of this exceptional vessel is that, in

order to maintain her position with wind or sea on the beam, the two propellers were frequently worked at different speeds and sometimes in opposite directions. She furnishes, in fact, one of the most remarkable illustrations of the manœuvring power obtainable by the use of twin-screws.*

Jet-propelled vessels, when moving ahead at full speed, derive their steering power from the reaction of the water in the wake upon the rudder; and as previously explained, this is likely to be less than that on a rudder placed in the race of a screw. In the trials made with the twin-screw ship *Viper* and the jet-propelled *Waterwitch*, there was practical identity of length and draught, as well as approximate equality of displacement and speed; but the *Viper* was constructed with two deadwoods, and had a rudder on each, while the *Waterwitch* had only one rudder at work, the rudder at the fore end being locked. Hence any exact comparison between the manœuvring powers of the two systems of propulsion can scarcely be made from the trials of these ships; but the following facts may be interesting. When steaming full speed ahead, the *Viper* turned a circle in 3 minutes 17 seconds, as compared with 4 minutes 10 seconds for the *Waterwitch*; a saving of time in the twin-screw ship of about 20 per cent. With one screw reversed, the other full speed ahead, and the rudders hard over, the *Viper* turned on her centre in rather less time than with both screws working full speed ahead (3 minutes $6\frac{1}{2}$ seconds, mean of trials in opposite directions).† The *Waterwitch*, under similar conditions, with one nozzle reversed, also turned on her centre, but occupied more than twice the time of the *Viper* ($6\frac{1}{2}$

* See an account of the vessel, communicated by Mr. C. W. Merrifield, F.R.S., to the Institution of Naval Architects in 1876.

† It will be observed that this is an exception to the deduction marked No. 3 on p. 610; but the explanation of the difference is simple. As

the *Viper* has two rudders, that placed behind the screw, which was driving the ship ahead, always remained thoroughly efficient in assisting to turn the ship, although the other rudder, placed behind the screw, which was driving the ship astern, was less efficient.

minutes), and half as long again as she took when steaming full speed ahead. Making allowance for the additional rudder of the *Viper*, and the additional resistance to turning which her peculiar form of stern involves, it appears that the twin-screws possess some advantages over the jets in manœuvring; but further trials would be required to settle this point conclusively. It is, however, certain that ample manœuvring power can be secured with twin-screws in association with greater propelling efficiency than has yet been obtained, or is likely to be secured with water-jets.

In conclusion it may be remarked that, throughout the preceding discussion, it has been assumed that the manœuvres of ships are performed in smooth water, in order that the principles of the action of the rudder, or of auxiliary appliances for steering, might be more simply explained. When ships are manœuvred in rivers, currents, or a seaway, their performances necessarily differ from those in still water; but all the varying conditions of practice can scarcely be brought within the scope of exact investigation; and the foregoing statement of principles will probably enable the conditions of any selected case to be intelligently treated.



I N D E X.

A.

	PAGE
<i>Achilles</i> , her Majesty's ship :—	
Watertight subdivision of	32
Principal dimensions and curve of stability	101
Performances at sea	198
Sailing capabilities	471
Admiralty—	
Regulations for preservation of iron ships	400
Coefficients for steamship performance	540
<i>Agincourt</i> , her Majesty's ship :—	
Grounding on Pearl Rock	33, 404
Behaviour at sea	205, 210, 229
Air resistance to motion of ships	466, 468
Airy, Sir G.: proposed use of steering screws	605
<i>Alexandra</i> , her Majesty's ship :—	
Approximate calculation for displacement	6
Watertight subdivision	32
Metacentric height	66
Steaming capabilities	544
<i>Alma</i> class, French ironclads: principal dimensions, and metacentric height	66, 73
<i>Amazon</i> , her Majesty's ship: loss of, by collision	301
American—	
Monitors (see Monitors).	
Tonnage law for war-ships	47
River steamers: special construction of	297, 338
Wood-built ships, rapid decay of	392
Angular velocity of ships—	
When rolling	106, 129
When turning	590
Antoine, M.: analysis of observations of waves	171
Ardency of sailing ships	484
Armour—contribution of, to structural strength of ships	343
.. . progress in manufacture of	402

	PAGE
Armoured ships (see Ironclads).	
Atwood's formula for statical stability	96
Automatic instruments for measuring rolling	251
Axis of rotation—of a ship when rolling	109
" " of a ship when turning	588
B.	
Balanced rudders: their advantages and disadvantages ..	569, 594
Barnaby, Mr.: remarks on—	
Influence of freeboard and beam on stability	100
Behaviour of <i>Inconstant</i>	191
Use of steel for shipbuilding	424
Sailing capabilities of the ironclads	490
Steering of ships	581
Use of steering screws	605
Barques: plain sail of	485
" position of centre of effort of sail	493
" stations of masts and base of sail	495
Base of sail, in various classes of sailing vessels	495
Batten instruments for observing rolling and pitching	246
Beam of ships:—	
Effect upon the metacentric stability	69
Effect upon the range of stability	98
Effect upon the resistance and propulsion	445, 552
Ratio to length in sailing vessels	502
Ratio to length in merchant steamers	457, 549
Ratio to length in unarmoured war-ships	457
Ratio to length in ironclads	456, 552
Beams: calculations of bending moments due to loads on	263
" principles of strength	318
" to decks: as transverse strengtheners of ships	300, 356
" " methods of scarphing wood	380
" " sectional forms in iron	385
" " approximate rules for strength	387
Bearers, longitudinal, contribute to local and general strength of ships	295
Beaufoy, Colonel: his experiments on resistance	430, 572
Behaviour of ships at sea (see Rolling and Pitching).	
<i>Bélier</i> class, French ironclads: particulars of, and metacentric height 66, 72	
<i>Bellerophon</i> , her Majesty's ship:—	
Accidental collision with <i>Minotaur</i>	34, 404
Tonnage B.O.M. compared with displacement	46
Principal dimensions and metacentric height	66, 73
Behaviour at sea	205, 210, 240

	PAGE
<i>Bellerophon</i> , her Majesty's ship (<i>continued</i>):—	
Longitudinal bending strains	271, 278
Weight of hull and carrying power	370
Steaming capabilities	541
Steering trials	581
Benazé, M. Duhil de:—	
Rolling experiments made by	128
Observations of waves made by	169
Bending moments:—	
Methods of estimating for beams	263
Longitudinal, for ships	263, 272
Transverse, for ships	284
Resistance of beams and girders to	318
Resistance of ships to longitudinal	320
Resistance of ships to transverse	351
Bernoulli, Daniel, his theory for rolling of ships	182
Bertin, M.:—	
Essay on the experimental study of waves	170
Automatic instrument for measuring rolling	251
Bilge-keels: means of increasing fluid resistance to rolling	125
" means of increasing steadiness in a seaway	219
<i>Birkenhead</i> , her Majesty's ship: loss of	407
<i>Black Prince</i> , her Majesty's ship (see also <i>Warrior</i>):—	
Weight of hull and carrying power	370
Steering trials of	581
<i>Boadicea</i> , her Majesty's ship: tonnage B.O.M. and displacement compared	46
Bottom, double (see Double Bottom)—	
Of iron ships, special dangers of	298, 394
Of wood ships, strong against grounding	298
Bouguer, M.: investigation of still-water oscillations by	105, 122
Boutakoff, Admiral: remarks on screw-ship steerage	593
Bow rudders	603
Bows of ships, influence of form upon pitching	230
" influence of form upon resistance	454
" construction of, for ramming	302
Bowspits, steeve of	496
Bracket frame system of construction for iron ships	331, 354
Breastwork monitors (see Monitors).	
Brigs; loss of older classes by swamping	16
" plain sail, and position of centre of effort	485, 493
" stations of masts, and base of sail	495
Brunel, Mr. I. K.: his connection with iron steam-ship building	329
Buckling, special danger of, in iron and steel ships	299, 329, 384, 425
Builders' old measurement tonnage:—	
Antiquity of rule	40

	PAGE
Builders' old measurement tonnage (<i>continued</i>):—	
Examples of calculation	43
Rationale of rule	45
Objections to and abolition of	47
Modification of, in United States navy	47
Bulkheads, as watertight subdivisions:—	
Arrangement of transverse	21
Arrangement of longitudinal	25, 33
Necessity for care of, and doors to	407
———, iron, as a protection against fire	408
———, as a means of maintaining stability	82, 84
———, as strengtheners:—	
Use of transverse	296, 361
Use of partial	353
Use of longitudinal	337
Buoyancy, definition of	3
" reserve of, in different classes of ships	12
" loss of, causes ships to founder	16
" centre of	60, 70
" strains due to unequal distribution of weight and	260, 272, 295
Butt-joints in wood ships	379, 382
" in iron ships	383

C.

<i>Cæsar</i> , line-of-battle ship: stoppage in launching	281
<i>Canonicus</i> , American monitor: reserve of buoyancy	12
<i>Captain</i> , her Majesty's ship (late):—	
Curve of stability and principal dimensions	101
Safety under sail in still water	137
Upsetting angle, amongst waves	213
Tripod supports to masts	293
Steering trials of	610
Cargoes, dangers of shifting	81
" stowage of, checked by rolling experiments	122, 130
Cellular construction for iron ships	299
Central-citadel ironclads, ram-bows of	304
" " " forms and proportions of	457, 552
Centre boards of sailing vessels	483
Centre of buoyancy, defined	60
" " approximate rules for position of	70
" " motion of, as ship heels	95, 99
Centre of effort of sails, method of estimating position	492
" " " longitudinal position of	493, 497
" " " vertical position of	495, 501
Centre of flotation	110

	PAGE
Centre of gravity :—	
Weight may be supposed concentrated at, in ship at rest ..	60
Height of metacentre above, in various classes of ships ..	66, 72
Experiment to determine vertical position of	77
Motion of, when weights are shifted	79, 86
Effect of vertical position of, upon range of stability ..	100
Effect of position relatively to centre of effort of sails ..	497
Centre of lateral resistance	492
Centre of pressure on rudder	579
<i>Cerbère</i> , French ironclad ram :—	
Dimensions, &c. of	72
Period of still-water oscillation	114
Chinese junks, steerage of	573, 601
Cigar-ships :—	
Conditions of stability for	75
Curve of stability	97
Still-water oscillations of	109, 112
Circular ironclads, Russian :—	
Behaviour at sea	189
Weights of hull for	370
Steaming capabilities of	536, 553
Rudder arrangements and steerage	588, 599
Clinometers (see Pendulums).	
Clipper ships, proportions and performances	502
Coal consumption, rates of, for various types of engines ..	516
Coefficients of—	
Fineness, for displacement	4
Moment of inertia of plane of flotation	70
Resistance to rolling in still water	129
Friction	439
Steam-ship performance	539
Collision, examples of accidental	34
,, local strains produced by	300
,, construction of ram-bows to withstand	303
Compartments, watertight, methods of forming	21
,, ,, of ironclad ships	32
Composite ships :—	
Arrangements of decks	323
,, framing	328
,, skins	335
,, beam-end connections	357
Freedom from fouling	410
Compound engines: economy of fuel with	516
Compressive strengths of wood and iron	376
Copper sheathing, anti-fouling properties of	411
,, for iron ships	410, 415
Corinthian Yacht Club, rule for tonnage	49

	PAGE
Corrosion of iron ships, causes of	394, 416
" " experiments on rate of	398
" " means of preventing	400
Curtis, Mr. : his steering propeller	608
Curves of—	
Displacement	7
Tons per inch immersion	9
Stability	96
Flotation	110
Extinction for rolling in still water	124
Weight and buoyancy	265, 268
Loads and bending moment	266, 269
Resistance	463
Turning for steamers	593
Cutters, plain sail for	485
" position of centre of effort	494
" station of mast	495
<i>Cyclops</i> class, breastwork monitors :—	
Reserve of buoyancy	18
Watertight subdivision	32
Steaming capabilities	555
D.	
Danube rule for tonnage	57
Dead-weight tonnage for merchant ships	42
Decks :—	
Utilised as watertight partitions	27
Resistance of, to rolling and pitching, with low freeboard	128, 231
Local strains on	300
Contributories to longitudinal strength	323
Require strengthening in many iron ships	349
<i>Defence</i> class, her Majesty's ships :—	
Watertight subdivision of	32
Weight of hull and carrying power	370
Steering trials	609
Desbois, Admiral : his theory for wave heights	171
<i>Devastation</i> class, her Majesty's ships :—	
Tons per inch immersion	10
Reserve of buoyancy	13
Change of trim when compartments are bilged	25
Watertight subdivision of	32
Tonnage, B.O.M.	44, 46
Metacentric height	66
Curve of stability	101
Period of still-water oscillation	114

<i>Devastation</i> class, her Majesty's ships (<i>continued</i>):—		PAGE
Inclination under wind pressure	140
Mr. Froude's rolling experiments with model	125, 220
Performances at sea	199, 202, 229, 238	
Curves of weight, buoyancy, bending moment, &c.	268
Longitudinal bending moments among waves	275
Local strains in wake of turrets	294, 300
Maximum longitudinal strains on structure	349
Weight of hull and carrying power	370
Coal endurance of	516
Performances under steam	543
Compared with circular ironclads	553
Diagonal riders for ordinary wood ships	333
„ planking for wood and composite ships	336
„ framing for iron ships	338
<i>Dictator</i> , American monitor: breadth for tonnage	44
Dipping oscillations of ships	118
Disc area of screw-propellers	529, 536
Displacement:—		
Definition of term	1
Useful	3, 370
Approximate rules for	4
Curves of	7
Most suitable tonnage for war-ships	41
Compared with B.O.M. tonnage	46
Recommended for yachts	50
Compared with gross register tonnage	58
Double bottoms:—		
Uses of, in iron ships	29, 33
Effect upon stability of water ballast in	84
Cellular construction of	299, 337
Facilitate preservation of skins	401
Draught of water:—		
Displacement for any	8
Changes in, by addition or removal of weight	9
Changes in, by altered density of water	11
Effect upon, of entry of water into hold	21
With changes of trim	87
Durability of wood and iron ships compared	389
Dynamical stability (see Stability).		

E.

Economical propulsion of steam-ships:—		
Favoured by suitable forms and proportions	454, 549
Favoured by increase in size	555
Not of paramount importance in all cases	460, 550

	PAGE
Eddy-making resistance of ships	428, 441, 458
Efficiency of marine engines	518
" of propellers	519
<i>Encounter</i> , her Majesty's ship: approximate calculation of displacement	5
<i>Endymion</i> , unarmoured screw-frigate: principal dimensions and curve of stability	101
Engines, marine:—	
Measures of power	511
Types in common use	515
Weights per horse-power, and rate of coal consumption ..	516
Of swift steam-launches	563
Entrance of ships: connection between speed and length of ..	445
Equilibrium of ships:—	
When floating freely in still water	60
Stable, unstable, and indifferent	63, 74
Instantaneous position of, among waves	185
Experiments:—	
To determine vertical position of centre of gravity of ships ..	77
Still-water rolling	122
On the effect of bilge-keels	125, 220
On strengths of timber	374, 376
On strengths of iron and steel	373, 376, 421
On rate of corrosion of iron	399, 417
On waste of metals in sea-water	414
Against targets representing sides of unarmoured iron ships	420
On resistance of ships	429, 439, 450, 461, 473, 572
On air resistance	468, 471
On screw propulsion	532, 535
On screws and paddle-wheels	533
On screws and water-jets	524
On steerage of single-screw ships	576, 593
On steerage of twin-screw ships	609
On steerage of jet-propelled ships	612
F.	
Factors of safety for wood and iron	373, 377
Fairbairn, Sir W.:—	
Proposed standard of strength for ships	280
Experiments on resistance of wood and iron to penetration ..	298
<i>Faraday</i> , cable-ship:—	
Bow rudder fitted to	604
Twin-screw arrangements of	611
Fastenings, in ships, importance of proper	311

	PAGE
Fastenings, in ships, metal bolts in wood ships	381
<i>Ferdinand Max</i> , Austriam ram, at Liassa	301
Fillings, between frames of wood ships, very useful ..	299, 325
Fincham, Mr. : his treatise on Masting	473, 488
<i>Flandre</i> class, French ironclads :—	
Principal dimensions and metacentric height	66, 73
Period of still-water oscillation	114
Flanged forms of beams and girders, very advantageous ..	319, 385
Formulæ :—	
Atwood's, for statical stability	96
For period of unresisted rolling	112
Moseley's, for dynamical stability	134
For trochoidal waves	167
Admiralty, for steam-ship performance	540
Expressing relative economy of steam-power in large and small steamers	556, 558
Fouling of bottom :—	
Especial disadvantage of iron ships	409
Proposals for preventing	419
Effect on resistance of ships	440
Foundering of ships, causes of	16
Fowler steering propeller	608
Framing of ships :—	
Subordinate to skins	310
Transverse, in wood ships	325, 352
Transverse, in iron and composite ships	326, 353
Longitudinal, for iron ships	327
Diagonal, for iron ships	338
Freeboard, various rules for	36
" effect of, upon the stability	98
Freight tonnage	59
French experiments on still-water oscillations	128
" observations of deep-sea waves	169
" rule for nominal horse-power	513
French war-ships :—	
Principal dimensions and metacentric heights for	66, 73
Periods of oscillation	114
Performance at sea	205
Frictional resistance, to rolling of ships	120
" to motion of ships	428, 438
" importance of	440, 458
Froude, Mr. W., F.R.S. :—	
Investigations on resistance to oscillations of ships ..	121, 219
Memorandum on observations of waves	157
Modern theory for rolling among waves	182
Report on behaviour of <i>Devastation</i>	199, 202

Froude, Mr. W., F.R.S. (continued):—		PAGE
Experiments on usefulness of bilge-keels		125, 220
Experiments on resistances of ships and models	427, 436, 455, 462,	590
Experiments on frictional resistance		439
Experiments on wave-making resistance		450
Experiments on air resistance		468, 472
On ratio of effective to indicated horse-power		518
Experiments on screw propulsion		532
Experiments on circular ships		553, 555
Experiments on planes and rudders		580, 601
 G. 		
Galvanic action—accelerates corrosion of iron skins		399
" means of preventing		400
" special danger in iron ships copper-sheathed		416
" assists in preventing fouling of zinc sheathing		418
Girders, equivalent, for longitudinal strength of ships		313
" principles of strength		318
" lattice, used as strengtheners to shallow ships		340
" comparison of ribs and adjacent parts of skin to		352
<i>Glatton</i> , her Majesty's monitor:—		
Watertight subdivision		32
Tonnage B.O.M. and displacement		46
Principal dimensions and metacentric height		66, 72
Curve of stability for		101
Safety in a seaway		212
<i>Gloire</i> , French ironclad: principal dimensions and metacentric height		66, 73
<i>Great Britain</i> , early iron steam-ship:—		
Principal dimensions of		368
Remarkable durability		396
Damage done by grounding		403
Steering trials of		576
<i>Great Eastern</i> :—		
Principal dimensions of		368
Great length reduces pitching		227
Framed on longitudinal system		296, 329
Cellular upper deck		300, 324
Small amount of transverse framing		354
Damage done by accidental grounding		33, 404
<i>Great Western</i> , pioneer Atlantic steamer: principal dimensions and performance of		
		368, 506
<i>Greyhound</i> , her Majesty's ship:—		
Rolling experiments in still water		126
" " in a seaway		220
Experiments conducted by Mr. Froude on the resistance	453, 459, 467	

<i>Greyhound</i> , her Majesty's ship (<i>continued</i>):—	PAGE
Model experiments on resistance	464
Estimate for angle of leeway	482
Used as basis for calculations of performance under steam of	
large ships	546, 558
Effective horse-power	545
Grounding, local strains produced by	297
Gumpel, Mr. : proposed form of rudder	602
Gunboats, unarmoured : use of iron hulls for	421
" selection of forms and proportions for	461
" engine-power and speeds	565
Gyroscopic instruments used for measuring rolling	241

H.

Head resistance, to motion of bodies through water	428
Headway, advantage to ships in turning	590
Heaving of ships among waves	155, 216
Heeling, produced by entry of water into hold	26
" produced by action of wind on sails	62, 135, 290, 478, 498
" produced by shifting weights athwartships	79
" produced by turning	591
Helm, port and starboard : weather and lee	570
" importance of quick motion	594
" angle of greatest efficiency	596
" power to put it over	578
<i>Hercules</i> , her Majesty's ship :—	
Reserve of buoyancy	13
Watertight subdivision of	32
Accidental collision with <i>Northumberland</i>	34
Principal dimensions and metacentric height	66, 73
Period of still-water oscillation	105
Behaviour at sea	199, 205, 210
Racking forces due to rolling	288
Steaming capabilities	542, 546, 550
Rudder arrangements	569
Steering trials of	582, 594, 595
Hogging, causes of, in still water	261
" on wave crest	274
" conditions of strain incidental to	282, 321
Holyhead packets, small register tonnage of	56
" " steaming capabilities of	529, 561
Horse-power of marine engines : effective	510, 518
" " " indicated	511
" " " nominal	512

<i>Hotspur</i> , her Majesty's ironclad ram :—	PAGE
Watertight subdivision of	32
Longitudinal stability of	90
Hulls of ships :—	
Should combine lightness with strength	3
Weights of, for various classes	370
Advantages of iron as compared with wood	368
Suitability of iron for unarmoured war-ships	419
Recent use of steel	424

I.

<i>Inconstant</i> class, Royal Navy :—	
Coefficient of fineness for displacement	4
Reserve of buoyancy	14
Principal dimensions and metacentric height	67, 72
Curve of stability for	101
Results of rolling experiments	114, 124, 130
Behaviour at sea	191
Errors of pendulum observations of rolling	239
Structural arrangements of	355
Weight of hull and carrying power	370
Copper sheathing on iron hull	415
Steaming capabilities	561, 564
<i>Independenzia</i> , Brazilian ironclad : stoppage in launching	281
<i>Inflexible</i> , her Majesty's ship :—	
Watertight subdivision of	32
Principal dimensions	366
<i>Invincible</i> class, Royal Navy :—	
Tons per inch immersion	10
Watertight subdivision of	32
Curve of stability for	101
Strength of ram-bow in	302
Steering trials	609
Iron, as a material for shipbuilding :—	
Resistance to perforation	298
Compared with wood	369
Tensile and compressive strength of	373, 376
Simple combinations possible with	382
Modulus of elasticity	378
Resistance to bending strains	385
Progress in manufacture of	402
(See also Corrosion and Fouling.)	
Ironclads :—	
Coefficients of fineness for displacement	4
Tons per inch immersion	10
Reserve of buoyancy	12

Ironclads (<i>continued</i>):—	PAGE
Watertight subdivision of	32
Metacentric heights of	66
Curves of stability	101
Behaviour at sea	199, 205, 210
Structural arrangements	331, 354
Local requirements in structures	342
Longitudinal strains of	349
Weights of hull for	370
Rapid decay of wood-built	393
Cost of maintenance and repairs	405
Sailing capabilities of	489, 500
Speeds under steam	507, 549
Long and short types compared	550
Expenditure of engine-power	565
Rudder areas of	599
(See also Circular Ironclads and Monitors.)	
<i>Iron Duke</i> , her Majesty's ship:—	
Collision with <i>Vanguard</i>	34
Approximate estimate for centre of buoyancy and metacentre	70
Strength of ram-bow	302
Steering trials	609
Iron ships:—	
Penetrability of bottom	298, 408
Construction of ram-bows	302
Methods of framing ordinary and special	324, 353
Skins of	337
Construction of decks	357
Progress in construction and sizes	364
Features of superiority to wood ships	369
Causes of corrosion	394, 416
Fouling of bottoms	409
Copper and zinc sheathing for	410
Great durability of	395, 398
Compared with steel ships	421
Isochronism of oscillations of ships in still water	115

J.

Jet-propelled vessels:—	
Steaming capabilities of	521
Steerage of	573, 612
Joessel rudders	602
Junks, Chinese, steerage of	573, 601
<i>Juno</i> , her Majesty's ship: dimensions and curve of stability	101
Jury rudders	607

K.

	PAGE
Keels, method of scarphing in wood ships	379
„ sliding, to diminish leeway	483
„ bilge (see Bilge-keels).	
Keelsons, longitudinal strengtheners	295, 325
„ method of scarphing	379
Kemp, Mr. Dixon : Treatise on Yacht Designing	489
Knees, to beams : methods of fitting	358

L.

Lap-joints for iron plates and bars	383
Lateral resistance (see Resistance).	
Launches, steam, of Royal Navy	336
„ swift-steam : position of screws in	533
„ „ remarkable speeds of	560
„ „ distribution of weights	562
„ „ engines of	516, 563
Launching : severe strains due to accidents in	281
Leaks, rate of inflow of water through	19
„ usefulness of stoppers	20
Leeboards, use of, in shallow-draught vessels	483
Lee-helm	570
Leeway : causes of, in ships sailing on a wind	477
„ angle of	479
Lewal, M. : on screw-ship steerage	593
Lloyd's rule for freeboard	36
„ Register, rules for wood and iron ships	391, 398
„ „ investigations on masting	292
Local strains (see Strains).	
London, steamship : lost by foundering	16
Longitudinal bending moments (see Bending).	
„ bulkheads (see Bulkheads).	
„ framing well adapted for iron ships	296, 299, 327
„ oscillations (see Pitching).	
„ strength (see Strength).	
Lord Warden, her Majesty's ship : behaviour at sea	199, 240
Lumley, Mr. : his plan of rudder	603
Lurching : strains consequent upon	290
Lutschaunig, Herr : his steering screw	605

M.

<i>Magenta</i> , French ironclad :—		PAGE
Period of oscillation	114
Behaviour at sea	205
Mallet, Mr. : his experiments on the corrosion of iron	397, 417
<i>Marengo</i> , French ironclad : metacentric height	66
<i>Mary</i> , merchant steamer : lost by cross-breaking	312, 384
Masts, stations of, in sailing vessels	494
„ rake of	495
„ proportion of sail carried by each of the	497
„ heights of	501
Materials for shipbuilding (see Iron, Steel, Wood).		
<i>Megæra</i> , her Majesty's ship : rate of corrosion of skin and loss of 400, 416		
Merchant ships :—		
Coefficients of fineness for displacement	4
Reserve of buoyancy	14
Waterlogged vessels	17
Rules for freeboard	36
Dead-weight tonnage for	42
Register tonnage for British	51
Suez Canal tonnage for	57
Stability under different conditions	67
Check upon stowage of cargoes	122, 130
Longitudinal bending moments experienced by	278
Longitudinal strains on iron	348
Weights of hull and carrying power	370
Ratios of length to breadth	455, 502, 549
Nominal horse-power for engines of	514
Sailing capabilities of	502
Steaming capabilities of	507, 549, 565
Rudder areas for	598
<i>Merkara</i> , steam-ship :—		
Mr. Froude's experiments on model of, and alternative forms	451, 459	
Compared with enlarged ship	558
Effective horse-power in	545
<i>Merrimac</i> : use of ram in her fight with the <i>Monitor</i>	302
Metacentre for transverse inclinations :—		
Explanation of term	64
Height above centre of gravity	66, 72
Approximate rules for estimating position of	70
Change of position due to entry of water into the hold	82
Motion during rolling	112

	PAGE
Metacentre for transverse inclinations (continued):—	
Effect of metacentric height upon period of still-water oscillations	113
Metacentre for longitudinal inclinations :—	
Height above centre of gravity in various classes	88
Use of, in estimating change of trim	89
Metals, rates of waste in sea-water	414
" galvanic action on iron	417
<i>Miantonomoh</i>, American monitor :—	
Reserve of buoyancy	13
Principal dimensions and metacentric height	66, 72
Curve of stability for	101
Performances in crossing Atlantic	189, 232
<i>Minotaur</i> class of Royal Navy :—	
Coefficient of fineness for displacement	4
Watertight subdivision of	32
Accidental collisions with other ironclads	34
Tonnage B.O.M. and displacement	46
Principal dimensions and metacentric height	66, 73
Behaviour at sea	199, 205, 210, 240
Curves of weight and buoyancy	265
Longitudinal bending moments	266, 274
Transverse compression	285
Longitudinal strains on structure	349
Performances under steam	549, 565
Steering trials	581
Model experiments on the efficiency of bilge-keels	125, 220
" on the resistances of ships	462
Moduli of elasticity : method of estimating	372
" " values for iron and timbers	378
Moment :—	
Righting, for transverse inclinations	61, 96
To change trim	90
Of inertia : explanation of term	108
Of inertia : its effect on rolling	116
Longitudinal bending	260, 272
Transverse bending	285
Of resistance of girders and ships to bending	319, 346
Of inertia : its effect on turning	586
<i>Monarch</i>, her Majesty's ship :—	
Watertight subdivision of	32
Principal dimensions and metacentric height	73
Curve of stability for	101
Safety in squalls	137, 214
Behaviour at sea	191
Supports to masts	292

	PAGE
Monitors, American :—	
Weight of hull and carrying power	370
Reserve of buoyancy	12
Loss by foundering	16
Rules for tonnage	47
Metacentric heights	66
Curve of stability	101
Periods of oscillation	114
Behaviour at sea	128, 189, 223, 232
Errors of pendulum observations for	239
Decay of wood-built	396
Multiple screws of shallow draught	536
Monitors, English (see <i>Cyclops, Devastation, Glatton</i>).	
Mottez, Captain: his observations on waves and the behaviour of	
ships	155, 164
Mulley, Mr.: his auxiliary rudder	606
Muntz metal for sheathing ships	412, 417

N.

Nelson class, Royal Navy :—	
Watertight subdivision	32
Special structural arrangements	421
Neutral axis and neutral surface of beams	317
Normand, M.: his instrument for measuring rolling	245
<i>Northumberland</i>: damage done to, by collision	34
" accident in launching	281

O.

Observations of dimensions and periods of waves	157, 164
" rolling and pitching, by pendulums	235
" " " by spirit-levels	240
" " " by gyroscopic instruments	241
" " " by batten instruments	246
" " " by automatic instruments	252
<i>Onondaga</i> (American type), French monitor: metacentric height	
and still-water period	114
Oscillations of ships (see <i>Dipping, Pitching, Rolling</i>).	

P.		PAGE
<i>Pacific</i> , steamship: loss of		305
Paddle-wheels:—		
Principles of propulsion by		525
Practical rules for		526
Disadvantages in sea-going steamers		527
Compared with water-jet propellers		528
Compared with screws		533
High speed obtained in ships driven by		529
For manœuvring		606
Panting, produced by transverse compression on ends of ships ..		286
Paris, Admiral (of French Navy):—		
Wave-tracer		163
Gyroscopic instrument for measuring rolling		244
Paris, Lieutenant (of French Navy): observations on winds and waves		169, 177, 472
Pendulums:—		
Comparison of oscillations with those of ships		103
Discussion of motion of simple and bar		106
Departure from isochronism with large angles of swing ..		197
Use of, to illustrate behaviour of ships at sea		203
Use of, for measuring rolling and pitching		235
Periods of rolling for ships in still water		112
" " " " experiments to determine them		122
" of pitching for ships		224
" of ocean waves: formulæ for		167
" " " methods of observing		157
" " " facts respecting		164, 170
<i>Perseverance</i> , her Majesty's troopship: capsizing in dock		93
<i>Persia</i> , early iron steamer: collision with iceberg		305
Pillars, contribution to structural strength		356
Pitch of screw-propellers		529
Pitching and 'scending of ships:—		
Periods for		224
Causes of		225
Governing conditions		226
Influence of form of bow and stern, and longitudinal distribution of weights		230
Of low-ended ships		231
Planking of wood ships (see Skins).		
Platforms, as watertight partitions		27
" effect on maintenance of stability		83
Plating of iron ships (see Skins).		
Portage of ships (see Tonnage).		

	PAGE
<i>Prince Consort</i> class (converted ironclads):—	
Principal dimensions and metacentric heights	66, 73
Period of rolling in still water	105, 114
Behaviour at sea	198, 238
Racking moment due to rolling	288
Longitudinal and stern strengthenings of	307, 323
<i>Prince of Wales</i> : accident in launching	282
Propellers :—	
Fundamental principles of	520
Water-jet	521
Paddle-wheels	525
Screws	529
Use of, for manœuvring	607
Propulsion by sails	470
„ by steam-power	506
„ strains incidental to	289, 306

R.

Racking strains on ships: produced by rolling	287
„ „ incidental to propulsion	289, 293
„ „ mode of resisting	333, 337
Radius of gyration: defined	108
„ effect upon period of rolling	113
„ effect upon period of pitching	225
„ effect upon turning	586
Rake of sternposts in yachts and ships	43
„ of masts	495
Ram attacks, best met by watertight subdivision	33
„ construction of bows to meet strains of	301
Rankine, (the late) Professor: remarks on—	
Dipping oscillations	119
Longitudinal bending moments	279
Racking strains due to rolling	288
Maximum strains on wood and iron ships	347
Steam-line theory of resistance	427, 433, 449
On manœuvring of ships	588
Proposed rudder	601
Reed, Mr. E. J. :—	
On the longitudinal strains of ships	264
On structures of iron ships	328, 354
On long and short types of ironclads	550

	PAGE
Register tonnage:—	
Law of 1854 and approximate rules	51
Allowances to steam-ships	54
Compared with displacement	58
Repairs: relative cost in iron and wood ships	403
Reserve of buoyancy for various types of ships	12
„ of dynamical stability	137
Resistance, lateral: to ships sailing on a wind	478
To turning of ships	587
Resistance of air to motion of ships	466
Resistance of water—	
To rolling of ships	120, 216
To pitching and 'scending	230
Resistance of water to advance of ships:—	
Early theories	426
Stream-line theory of	430
Frictional, direct, eddy-making	428
Wave-making	434
Variation in terms of speed of ships	453
Summary of results	458
Values of, for certain ships	459
Model experiments on	462
Ribs (see Framing, 'Transverse).	
<i>Richelieu</i> , French ironclad: dimensions and metacentric height	73
Riders, diagonal, for wood and composite ships	333, 335
Rigging, strains sustained by	290
„ air resistance to	466
River steamers, shallow-draught: special features of	297, 338
Rolling of ships in still water:—	
Oscillations resemble those of pendulums	103
Hypothetical case of unresisted rolling	104
Effect of moment of inertia upon	108
Instantaneous axis of rotation	109
Periods of	112
Effect of changes in stiffness and distribution of weights	113
Dipping oscillations which accompany	118
Effect of resistance upon	120
Still-water experiments on	122
Rolling of ships among waves:—	
Early theories	182
Governing conditions of	183
Importance of ratio of wave period to period of ships	187
Behaviour of quick-moving ships	188
„ of slow-moving ships	190
Sketch of modern theory	192
Dangers of synchronism of periods of ships and waves	194

Rolling of ships among waves (<i>continued</i>):—	PAGE
Permanent rolling	201
Pendulum illustrations of	203
Records of	204
Effects of changes in speed and course of ships	208
Phases of oscillation	209
Safety or danger in a seaway	212
Effect of resistance upon	217
Steadiness secured by bilge-keels	220
Steadying effect of sails	224
Strains on structure due to	287
Strains on rigging due to	290
Methods of measuring angles of (see Observations of Rolling).	
Rudders:—	
Ordinary and balanced	568, 580
Bow	603
Rankine's and Schlick's	601
Gumpel's and Joessel's	602
Lumley's	603
Auxiliary	606
Various forms in use	600
Effective pressures on	571
Centre of pressure of	579
Force required on tiller-end	578
Work done in putting hard-over	580
Turning effect on ships	584
Considerations respecting areas of	595, 598
Run of ships: connection between speed of ships and length of ..	445
„ fineness of, essential to efficiency of screw-steamers ..	538
„ effect of form upon rudder pressure	573
<i>Rupert</i> , her Majesty's ironclad ram: watertight subdivision ..	32
Russell, Mr. Scott:—	
Longitudinal system of framing iron ships	329
Wave-line theory of resistance	433, 447
Rules for paddle-wheels	526
Rule for rudder area	598
S.	
Sagging:—	
Causes of, in still water	261
Astride wave hollows	274
Conditions of strain incidental to	282, 321
Sailing vessels:—	
Register tonnage of	53
Heel of, under canvas	62, 136, 501

Sailing vessels (<i>continued</i>):—		PAGE
Under action of squalls of wind		137
Range of stability for safety		215
Steadying action of sails		224
Strains due to propulsion		289
Arrangement of sail plans by comparison		470
Propelling effect of wind on sails		475
Balance of sail		484
Plain sail for various styles of rig		485, 489
Determination of aggregate sail area		486
Position of centre of effort		491, 498
Base of sail		496
Forms and proportions of		502
High speeds of modern		504
Stiffness, or sail-carrying power		500
Steerage of		573
Areas and forms of rudders		598, 600
<i>Sarah Sands</i> : preserved from destruction by fire		408
Scarphs of various pieces in wood ships		379
*Scending (see Pitching).		
Schlick, Herr: experiments on screw-ship steerage		576, 601
Schooners: plain sail		485
" centre of effort		494
" stations of masts, and base of sail		495
Scoresby, Dr.: observations of waves by		164
Screw-propellers:—		
Diameter, pitch, disc area, and slip		529, 536
Principles of action		531
Virtual increase of resistance produced by		532
Compared with water-jets		523
Compared with paddle-wheels		533
Large diameters advantageous		535
Use of twin and multiple		536
Necessity for free flow of water to		538
Effect of propeller race upon steerage		574
Motion of particles in race		576
Manœuvring powers of single and twin		608
Screws, steering: modes of fitting		605
Sepping, Sir Robert: introduction of diagonal riders		333
<i>Serapis</i> , Indian troop-ship: curve of stability and principal dimensions of		101
Shallow-draught vessels: special structural arrangements		297, 338
" " difficulty of steering		593
Shearing strains on ships, unimportant		259
Sheer strakes, useful as longitudinal strengtheners		323
Shift of butts for planking and ribs of wood ships		315, 352

	PAGE
Ship-rig: plain sail of	485
„ stations of masts	495
„ position of centre of effort	493
„ base of sail	495
Skins of ships :—	
Resistance to penetration of wood and iron	298
Essential feature of all classes	310
Arrangements in wood ships	333, 336
Arrangements in composite ships	335
Arrangements in iron ships	337
Slackness of sailing ships	484
Slip of paddle-wheels	525
Slip of screw-propellers	530
Smyth, Piazzì, Professor: gyroscopic instrument for measuring rolling	241
Speeds of unarmoured war-ships and ironclads	507, 565
„ of merchant steamers	529, 565
„ of sailing ships	504
„ lengths of entrance and run appropriate to	445
Spirit-levels, not trustworthy means of measuring rolling	240
Stability, dynamical :—	
Definition of	131
Mode of estimating	133
Moseley's formula for	134
Effect of suddenly applied forces measured with reference to	135
Reserve of	137
Stability, statical :—	
Definition of	63
Metacentric method of estimating	65, 74
Of cigar and cylindrical ships	75
Of submarine vessels	76
Affected by shifting cargoes and free water in hold	81
Effect of adding or removing weights	84
Effect of raising or lowering weights	86
Of ships partially waterborne	92
Atwood's formula for	95
Construction and use of curves of	96
Amongst waves, reckoned from normal to effective slope	211
Range of stability required for safety	215
Effect of heaving motion upon	216
Steadiness :—	
Definition of	65
Increased by lengthening still-water period of ships	113, 190
Assisted by deep bilge-keels	220
Assisted by sails	224
Lessens transverse straining	288

Steam-ships:—	PAGE
Register tonnage of	54
Progress in construction of	506
Ordinary conditions of design	508
Measures of engine-power	511
Estimates of speed and engine-power	539, 545
Engine-power and speeds of various classes	565
Economical propulsion of	544
Steerage of	573
Steam steering gear: advantages of	582, 593
Steel, as a material for shipbuilding:—	
Features in which it is superior to iron	421
Objections to use of	422
Mild steel used in the Royal Navy	424
Precautions against buckling and corrosion	425
Steerage of sailing and steam ships	573
Steering-blades, use of	607
Steering-gear: manual	580
" steam and hydraulic	582
Steering-screws, proposed use of	605
Steering trials: initial motions of ships	585
" uniform motions of ships	589
" axis of rotation	584
" deductions from trials of steamers	593, 609
Steeve of bowsprits	496
Stern: strengthenings, of in wood screw-steamers	306
" effect of length and form upon resistance	442, 448
" fineness of form required for screw propulsion	538
Sternway, steerage of ships having	573, 576
Stiffness: definition of	65
" measured by metacentric height	66
" effects of form and stowage of ships upon	72
" effect of variations in, upon periods of oscillation	113
" measure of power to carry sail	500
Stowage of weights or cargo: effect upon stability	81, 84
" proposal to check by rolling experiments	130
" effect of, upon longitudinal bending moments	267
Strains experienced by ships:—	
Classification of principal	259
Longitudinal bending, in still water	260
" " among waves	272
" " when aground	280
Transverse: ship aground	283
" " afloat	285
" " rolling	286
Incidental to propulsion by sails	289

	PAGE
Strains experienced by ships (<i>continued</i>):—	
Incidental to propulsion by steam	293
Local : due to concentrated loads and supports	294
" " grounding	297
" on decks	300
" due to collision	300
" " propulsion	305
Measures of longitudinal, in mercantile and ironclad ships	346
Stream-line theory of resistance	430
Strength of shipbuilding materials (see Iron, Steel, Wood).	
Strength of ships :—	
General remarks on	309
Against longitudinal bending	312, 320
Against transverse strains	351
Against local strains	294
Considerations governing vertical and longitudinal distribution of the material	345
Stringers, on decks : valuable strengthenings	323, 330, 357
" in hold : uses of	296, 325
Subdivision, watertight (see Watertight Subdivision).	
Submarine ships : principles of construction	14
" stability of	76
" resistance of	428, 432
Suez Canal : tonnage for dues	57
<i>Sultan</i> , her Majesty's ship :—	
Coefficients of fineness for displacement	4
Reserve of buoyancy	13
Watertight subdivision	32
Still-water rolling experiments	114, 124, 130
Behaviour at sea	205, 210
Compound balanced rudder	569
Steering trials	594
Auxiliary rudders	607

T.

Tables:—

Coefficients of fineness, for displacement and tons per inch	4, 10
Watertight compartments of ironclads	32
Displacement and B.O.M. tonnage	46
Register tonnage of merchant steamers	56
Metacentric heights of war-ships	66, 73
Principal dimensions, &c. of war-ships	101
Periods of still-water rolling of war-ships	114
Particulars of stability for <i>Captain</i> and <i>Monarch</i>	138
Lengths, speeds, periods, &c. of ocean waves	168, 170, 172, 177

Tables (*continued*):—

	PAGE
Behaviour of ships at sea: observations of	199, 205, 206, 210, 240
Tangents of angles	248
Longitudinal bending moments of ships	276, 278
Longitudinal strains in merchant ships	348
Illustrating increase in sizes of ships	366
Weights of hull and carrying power	370
Strengths of shipbuilding timbers	374, 376, 385
Moduli of elasticity of iron and timbers	378
Corrosion and waste of metals in sea-water	414
Galvanic action of metals on iron	417
Comparative weights, &c. of iron and steel ships	425
Resistances of <i>Greyhound</i> and <i>Merkara</i>	459
Plain sail, with various styles of rig	485, 489
Calculation for centre of effort of sail	492
Stations of masts, base of sail, &c.	495
Particulars of <i>Pique</i> and <i>Thermopylae</i>	503
Nominal and indicated horse-power	512
Coal consumption, weights, &c. of marine engines	516
Particulars of <i>Hercules</i> and long type of ironclad	551
Illustrating economy of propulsion in large steamers	557
Illustrating great engine-power of swift launches	561
Of engine-power and speed for steamers	565
Steering trials of <i>Hercules</i> and <i>Warrior</i>	595
<i>Temeraire</i> , her Majesty's ship: watertight subdivision of	32
Tensile strengths of wood and iron	373
Thames' rules for yacht tonnage	49
Thibault, M.: on the impulse of wind on sails	474
Timbers, shipbuilding:—	
Tensile strengths and weights	374
Compressive strengths	376
Moduli of elasticity	378
(See also Wood.)	
Tonnage of ships:—	
Origin of term	39
Displacement	4, 41
Dead-weight	42
Builders' old measurement	43
United States navy	47
Yacht measurements	48
Register	50
Proposed amendments of register	56
Danube rule	57
Suez Canal rule	57
Freight	59
Tons per inch immersion	9

	PAGE
Torpedo attacks : watertight subdivision a precaution against ..	33
Transverse bulkheads (see Bulkheads).	
" oscillations (see Rolling).	
" strains on ships aground	283
" strains on ships afloat in still water	285
" strains on ships in a seaway	286
" strains on ships under sail	290
" strength	351
Trim of ships :—	
How measured	8
Affected by entry of water into hold	24
Estimates for change of	87
Change of, in ships under sail	289, 478
" when ships are turning	591
Tripod supports to masts	292
<i>Triumph</i> , her Majesty's ship: watertight subdivision	32
Trochoidal theory for waves (see Waves).	
Twin-screws : first used in shallow-draught ships	536
" recent good performances of deep-draught ships	544
" steering power of	609

U.

Unarmoured war-ships :—	
Co-efficients of fineness for displacement	4
Tons per inch immersion	10
Reserve of buoyancy	14
Metacentric heights	67
Curves of stability	101
Periods of oscillation and behaviour at sea	114, 206, 210
Structural arrangements	322, 352, 355
Dimensions and speeds of	366, 507
Weights of hull for	370
Use of iron hulls for	419
Sailing capabilities of	489, 500
Steaming capabilities of	561, 565
Useful displacement	3, 370
" work of marine engines	518
Utilisation of ocean-wave power	180

V.

<i>Vanguard</i> , her Majesty's ship :—	
Watertight subdivision	32
Remarks on collision with <i>Iron Duke</i>	34, 302, 407
Longitudinal bending moment	270, 271
Weight of hull and carrying power	370

<i>Victoria and Albert</i> , her Majesty's yacht :—						PAGE
Longitudinal bending moments	278
Structural arrangements	336
Performances under steam	561
<i>Volage</i> class of Royal Navy :—						
Co-efficient of fineness for displacement	4
Curves of extinction for still-water rolling	124, 130
Structural arrangements	355

W.

<i>Wampanoag</i> class, United States navy : failure of	367
<i>Warrior</i> class, Royal Navy :—						
Co-efficient of fineness for displacement	4
Watertight subdivision	32
Tonnage B.O.M. and displacement	46
Principal dimensions and metacentric height	66, 73
Longitudinal stability and change of trim	89
Sailing capabilities of	471
Steaming capabilities of	549, 565
Steering trials	572, 595
War-ships (see Ironclads and Unarmoured Ships).						
Water : weights per cubic foot of sea and river	2, 11
„ velocity of inflow into damaged ship	19
„ draught of (see Draught).						
„ not a perfect fluid	427
Water ballast : methods of carrying	33
„ effect upon stability	84
Water-jet propellers (see Jet Propellers).						
Waterlogged ships	17
Watertight subdivision :—						
Principles of	18
By transverse bulkheads	21
By longitudinal bulkheads	25
By decks and platforms	27
Of ironclads	32
Maintenance of stability by	81
Imperfection of, in many merchant ships	406
<i>Waterwitch</i> , her Majesty's ship :—						
Arrangement of jet propellers in	521
Steam trials	523
Bow rudder of	603
Steering trials	613
Wave-line theory of resistance	447

	PAGE
Wave-making resistance of water—	
To rolling of ships	120, 126
To advance of ships, defined	428
" " expenditure of force on	435
" " governing conditions of	443, 450
" " importance of at certain speeds	451, 458
Waves, deep-sea :—	
Advance of form, and motion of particles	142, 145
Construction of profiles	143
Internal structure	147
Fluid pressures in	151, 215
Maximum slopes	153
Heaving motion produced by	155
Methods of observing dimensions	157
Summary of observed dimensions	164, 169
Errors in estimates of heights	165
Ratios of heights to lengths	166, 209
Theoretical formulæ for	167
Dimensions corresponding to forces of wind	171
Superposition of series	178
Utilisation of power	180
Effective slope of	185, 256
Influence of ratio of wave period to still-water period of ship	113, 183, 207
Oscillations of ships amongst (see Pitching and Rolling).	
Longitudinal strains of ships amongst	272
Transverse strains of ships amongst	288
<i>Woechawken</i> , American monitor, foundering of	16
Weights, per cubic foot—	
Of sea and river water	2, 11
Of iron	373
Of principal shipbuilding timbers	374
Weights of hulls in various classes of ships	370
" per indicated horse-power for various types of marine engines	516
Winds :—	
Normal pressures, forces, and speeds of	472
Oblique action on sails	473
Connection between force of wind and dimensions of waves	171
Condition of ships sailing on	475
Wing-passages of ironclads	33
Wood, as a material for shipbuilding :—	
Resistance to perforation	298
Compared with iron	369
Tensile and compressive strengths of	374, 376
Resistance of combinations to tensile and compressive strains	378

50A, ALBEMARLE STREET, LONDON,
September, 1877.

MR. MURRAY'S
GENERAL LIST OF WORKS.

- ABINGERS (LORD Chief Baron of the Exchequer) Life. By the Hon. P. CAMPBELL SCARLETT. Portrait. 8vo. 15s.
- ALBERT MEMORIAL. A Descriptive and Illustrated Account of the National Monument erected to the PRINCE CONSORT at Kensington. Illustrated by Engravings of its Architecture, Decorations, Sculptured Groups, Statues, Mosaics, Metalwork, &c. With Descriptive Text. By DOYNE C. BELL. With 24 Plates. Follo. 12l. 12s.
- HANDBOOK TO, 1s.; or Illustrated Edition, 2s. 6d.
- (PRINCE) SPEECHES AND ADDRESSES, with an Introduction, giving some outline of his Character. With Portrait. 8vo. 10s. 6d.; or *Popular Edition*, fcap. 8vo. 1s.
- ALBERT DÜRER; his Life, with a History of his Art. By DR. THAUSING, Keeper of Archduke Albert's Art Collection at Vienna. Translated from the German. With Portrait and Illustrations. 2 vols. 8vo. [In the Press.]
- ABBOTT'S (REV. J.) Memoirs of a Church of England Missionary in the North American Colonies. Post 8vo. 2s.
- ABERCROMBIE (JOHN). Enquiries concerning the Intellectual Powers and the Investigation of Truth. Fcap. 8vo. 3s. 6d.
- Philosophy of the Moral Feelings. Fcap. 8vo. 2s. 6d.
- AOLAND (REV. CHARLES). Popular Account of the Manners and Customs of India. Post 8vo. 2s.
- ÆSOP'S FABLES. A New Version. With Historical Preface. By Rev. THOMAS JAMES. With 100 Woodcuts, by TENNIEL and WOLF. Post 8vo. 2s. 6d.
- AGRICULTURAL (ROYAL) JOURNAL. (*Published half-yearly.*)
- AIDS TO FAITH: a Series of Theological Essays. By various Authors. 8vo. 9s.
- Contents*:—Miracles; Evidences of Christianity; Prophecy & Messianic Record of Creation; Ideology and Subription; The Pentateuch; Inspiration; Death of Christ; Scripture and its Interpretation.
- AMBER-WITCH (THE). A most interesting Trial for Witchcraft. Translated by LADY DUFF GORDON. Post 8vo. 2s.
- ARMY LIST (THE). *Published Monthly by Authority.*
- ARTHUR'S (LITTLE) History of England. By LADY CALLOTT. *New Edition, continued to 1872.* With 36 Woodcuts. Fcap. 8vo. 1s. 6d.
- AUSTIN (JOHN). LECTURES ON GENERAL JURISPRUDENCE; OR, the Philosophy of Positive Law. Edited by ROBERT CAMPBELL. 2 Vols. 8vo. 82s.
- STUDENT'S EDITION, by ROBERT CAMPBELL, compiled from the above work. Post 8vo. 12s.
- Analysis of. By GORDON CAMPBELL, M.A. Post 8vo. 6s.
- ARNOLD (THOS.). Ecclesiastical and Secular Architecture of Scotland: The Abbeys, Churches, Castles, and Mansions. With Illustrations. Medium 8vo. [In Preparation.]

ATKINSON (DR. R.) *Vie de Seint Auban. A Poem in Norman-French.* Ascribed to MATTHEW PARIS. With Concordance, Glossary and Notes. Small 4to, 10s. 6d.

ADMIRALTY PUBLICATIONS; Issued by direction of the Lords Commissioners of the Admiralty:—

A MANUAL OF SCIENTIFIC ENQUIRY, for the Use of Travellers. *Fourth Edition.* Edited by ROBERT MAIR, M.A. Woodcuts. Post 8vo. 3s. 6d.

GREENWICH ASTRONOMICAL OBSERVATIONS 1841 to 1846, and 1847 to 1871. Royal 4to. 20s. each.

MAGNETICAL AND METEOROLOGICAL OBSERVATIONS. 1840 to 1847. Royal 4to. 20s. each.

APPENDICES TO OBSERVATIONS.

1837. Logarithms of Sines and Cosines in Time. 3s.

1842. Catalogue of 1439 Stars, from Observations made in 1836 to 1841. 4s.

1845. Longitude of Valentia (Chronometrical). 3s.

1847. Description of Altazimuth. 3s.

Twelve Years' Catalogue of Stars, from Observations made in 1836 to 1847. 4s.

Description of Photographic Apparatus. 2s.

1851. Maskelyne's Ledger of Stars. 3s.

1852. I. Description of the Transit Circle. 3s.

1853. Refraction Tables. 3s.

1854. Description of the Zenith Tube. 3s.

Six Years' Catalogue of Stars, from Observations. 1848 to 1853. 4s.

1862. Seven Years' Catalogue of Stars, from Observations. 1854 to 1860. 10s.

Plan of Ground Buildings. 3s.

Longitude of Valentia (Galvanic). 2s.

1864. Moon's Semid. from Occultations. 2s.

Planetary Observations, 1831 to 1835. 2s.

1868. Corrections of Elements of Jupiter and Saturn. 2s.

Second Seven Years' Catalogue of 2760 Stars for 1861 to 1867. 4s.

Description of the Great Equatorial. 3s.

1866. Descriptive Chronograph. 3s.

1860. Reduction of Deep Thermometer Observations. 2s.

1871. History and Description of Water Telescope. 3s.

Cape of Good Hope Observations (Star Ledgers). 1856 to 1863. 2s. 1856. 5s.

Astronomical Results. 1857 to 1858. 5s.

Report on Tenerife's Astronomical Experiment. 1836. 5s.

Paramatta Catalogue of 7385 Stars. 1822 to 1826. 4s.

ASTRONOMICAL RESULTS. 1847 to 1871. 4to. 3s. each.

MAGNETICAL AND METEOROLOGICAL RESULTS. 1847 to 1871. 4to. 3s. each.

REDUCTION OF THE OBSERVATIONS OF PLANETS. 1750 to 1830. Royal 4to. 20s. each.

LUNAR OBSERVATIONS. 1750 to 1830. 2 Vols. Royal 4to. 20s. each.

1831 to 1851. 4to. 10s. each.

BERNOULLI'S SEXCENTENARY TABLE. 1779. 4to. 5s.

BESSEL'S AUXILIARY TABLES FOR HIS METHOD OF CLEARING LUNAR DISTANCES. 8vo. 2s.

ENCKE'S BERLINER JAHRBUCH, for 830. Berlin, 1838. 8vo. 8s.

HANSEN'S TABLES DE LA LUNE. 4to. 20s.

LAX'S TABLES FOR FINDING THE LATITUDE AND LONGITUDE 1821. 8vo. 10s.

LUNAR OBSERVATIONS at GREENWICH. 1760 to 1819. Compared with the Tables, 1821. 4to. 7s. 6d.

MACLEAR ON LACAILLE'S ARC OF MERIDIAN. 2 Vols. 20s. each.

ADMIRALTY PUBLICATIONS—*continued.*

- MAYER'S DISTANCES of the MOON'S CENTRE from the PLANETS. 1822, 3s.; 1823, 4s. 6d. 1824 to 1835. Svo. 4s. each.
- TABULÆ MOTUUM SOLIS ET LUNÆ. 1770. 5s.
- ASTRONOMICAL OBSERVATIONS MADE AT GOTTINGEN, from 1756 to 1761. 1826. Folio. 7s. 6d.
- NAUTICAL ALMANAC, from 1767 to 1877, 80s. 2s. 6d. each.
- SELECTIONS FROM, up to 1812. Svo. 5s. 1824-54. 5s.
- SUPPLEMENTS, 1823 to 1833, 1837 and 1838. 2s. each.
- TABLE requisite to be used with the N.A. 1781. Svo. 5s.
- SABINE'S PENDULUM EXPERIMENTS to DETERMINE THE FIGURE OF THE EARTH. 1825. 4to. 40s.
- SHEPHERD'S TABLES for CORRECTING LUNAR DISTANCES. 1772. Royal 4to. 21s.
- TABLES, GENERAL, of the MOON'S DISTANCE from the SUN, and 10 STARS. 1787. Folio. 5s. 6d.
- TAYLOR'S SEXAGESIMAL TABLE. 1780. 4to. 15s.
- TABLES OF LOGARITHMS. 4to. 60s.
- TIARK'S ASTRONOMICAL OBSERVATIONS for the LONGITUDE of MADRIRA. 1822. 4to. 5s.
- CHRONOMETRICAL OBSERVATIONS for DIFFERENCES of LONGITUDE between DOVER, PORTSMOUTH, and FALMOUTH. 1822. 4to. 5s.
- VENUS and JUPITER: OBSERVATIONS of, compared with the TABLES. London, 1822. 4to. 2s.
- WALES' AND BAYLY'S ASTRONOMICAL OBSERVATIONS. 1777. 4to. 21s.
- REDUCTION OF ASTRONOMICAL OBSERVATIONS MADE in the SOUTHERN HEMISPHERE. 1764-1771. 1788. 4to. 10s. 6d.
- BARBAULD (Mrs.). Hymns in Prose for Children. With Illustrations. Crown 8vo.
- BARCLAY (JOSEPH, LL.D.). The Talmud: being Selected Extracts, chiefly illustrating the Teaching of the Bible. With an Introduction describing the General Character of the Talmud. 8vo.
- BARKLEY (H. C.). Five Years among the Bulgarians and Turks between the Danube and the Black Sea. Post 8vo. 10s. 6d.
- My Boyhood: a True Story. With Illustrations. Post 8vo. A Christmas Book for Schoolboys and others.
- BARROW (SIR JOHN). Autobiographical Memoir, from Early Life to Advanced Age. Portrait. 8vo. 16s.
- (JOHN) Life, Exploits, and Voyages of Sir Francis Drake. Post 8vo. 2s.
- BARRY (SIR CHARLES). Life and Works. By CANON BARRY. With Portrait and Illustrations. Medium 8vo. 15s.
- BATES' (H. W.) Records of a Naturalist on the River Amazon during eleven years of Adventure and Travel. Illustrations. Post 8vo. 7s. 6d.
- BAX (CAPT. R.N.). Russian Tartary, Eastern Siberia, China, Japan, and Formosa. A Narrative of a Cruise in the Eastern Seas. With Map and Illustrations. Crown 8vo. 12s.
- BELCHER (LADY). Account of the Mutineers of the 'Bounty,' and their Descendants; with their Settlements in Pitcairn and Norfolk Islands. With Illustrations. Post 8vo. 12s.
- BELL'S (SIR CHAS.) Familiar Letters. Portrait. Post 8vo. 12s.

BELL (DOYNE C.). Notices of the Historic Interments in the Church of St. Peter ad Vincula, in the Tower of London, with an account of the discovery of the remains of Queen Anne Boleyn. With Illustrations. Crown 8vo. 14s.

BELT (THOS.). Naturalist in Nicaragua, including a Residence at the Gold Mines of Chontales; with Journeys in the Savannas and Forests; and Observations on Animals and Plants. Illustrations. Post 8vo. 12s.

BERTRAM (JAS. G.). Harvest of the Sea: an Account of British Food Fishes, including sketches of Fisheries and Flabber Folk. With 50 Illustrations. 8vo. 9s.

BIBLE COMMENTARY. EXPLANATORY and CRITICAL. With a REVISION of the TRANSLATION. By BISHOPS and CLERGY of the ANGLICAN CHURCH. Edited by F. C. COOK, M.A., Canon of Exeter. Vols. I. to VI. (The Old Testament). Medium 8vo. 6l. 15s.

Vol. I.	GENESIS. EXODUS. LEVITICUS. NUMBERS. DEUTERONOMY.	Vol. IV.	JOB. PSALMS. PROVERBS. ECCLESIASTES. SONG OF SOLOMON.
30s.		24s.	
Vols. II. and III.	JOSHUA, JUDGES, RUTH, SAMUEL, KINGS, CHRONICLES, EZRA, NEHEMIAH, ESTHER.	Vol. V.	ISAIAH. JEREMIAH. EZEKIEL. DANIEL.
36s.		20s.	
		Vol. VI.	MINOR PROPHETS.
		25s.	

BIGG-WITHER (T. P.). Pioneering in S. Brazil; three years of forest and prairie life in the province of Parana. Map and Illustrations. 8vo. [In the Press.]

BIRCH (SAMUEL). History of Ancient Pottery and Porcelain: Egyptian, Assyrian, Greek, Roman, and Etruscan. With Coloured Plates and 200 Illustrations. Medium 8vo. 42s.

BIRD (ISABELLA). Hawaiian Archipelago; or Six Months among the Palm Groves, Coral Reefs, and Volcanoes of the Sandwich Islands. With Illustrations. Crown 8vo. 7s. 6d.

BISSET (GENERAL). Sport and War in South Africa from 1834 to 1867, with a Narrative of the Duke of Edinburgh's Visit. With Map and Illustrations. Crown 8vo. 14s.

BLACKSTONE'S COMMENTARIES; adapted to the Present State of the Law. By R. MALCOLM KEER, LL.D. Revised Edition, incorporating all the Recent Changes in the Law. 4 vols. 8vo. 60s.

BLUNT (REV. J. J.). Undesigned Coincidences in the Writings of the Old and New Testaments, an Argument of their Veracity: containing the Books of Moses, Historical and Prophetical Scriptures, and the Gospels and Acts. Post 8vo. 6s.

——— History of the Church in the First Three Centuries. Post 8vo. 6s.

——— Parish Priest; His Duties, Acquirements and Obligations. Post 8vo. 6s.

——— Lectures on the Right Use of the Early Fathers. 8vo. 9s.

——— University Sermons. Post 8vo. 6s.

——— Plain Sermons. 2 vols. Post 8vo. 12s.

BLOMFIELD'S (BISHOP) Memoir, with Selections from his Correspondence. By his Son. Portrait, post 8vo. 12s.

- BOSWELL'S (JAMES)** Life of Samuel Johnson, LL.D. Including the Tour to the Hebrides. Edited by Mr. CHORKE. *Seventh Edition.* Portraits. 1 vol. Medium 8vo. 12s.
- BRACE (C. L.)** Manual of Ethnology; or the Races of the Old World. Post 8vo. 6s.
- BOOK OF COMMON PRAYER.** Illustrated with Coloured Borders, Initial Letters, and Woodcuts. 8vo. 18s.
- BORROW (GEORGE)** Bible in Spain; or the Journeys, Adventures, and Imprisonments of an Englishman in an Attempt to circulate the Scriptures in the Peninsula. Post 8vo. 5s.
- Gypsies of Spain; their Manners, Customs, Religion, and Language. With Portrait. Post 8vo. 5s.
- Lavengro; The Scholar—The Gypsy—and the Priest. Post 8vo. 5s.
- Romany Rye—a Sequel to "Lavengro." Post 8vo. 5s.
- **WILD WALES:** its People, Language, and Scenery. Post 8vo. 5s.
- Romano Lavo-Lil; Word-Book of the Romany, or English Gyp-y Language; with Specimens of their Poetry, and an account of certain Gypsyries. Post 8vo. 10s. 6d.
- BRAY (MRS.)** Life of Thomas Stothard, R.A. With Portrait and 60 Woodcuts. 4to. 21s.
- BRITISH ASSOCIATION REPORTS.** 8vo.
- | | |
|------------------------------------|------------------------|
| York and Oxford, 1831-32, 18s. 6d. | Glasgow, 1855, 15s. |
| Cambridge, 1833, 12s. | Cheltenham, 1856, 18s. |
| Edinburgh, 1834, 15s. | Dublin, 1857, 15s. |
| Dublin, 1835, 13s. 6d. | Leeds, 1858, 20s. |
| Bristol, 1836, 12s. | Aberdeen, 1859, 15s. |
| Liverpool, 1837, 16s. 6d. | Oxford, 1860, 25s. |
| Newcastle, 1838, 15s. | Manchester, 1861, 15s. |
| Birmingham, 1839, 18s. 6d. | Cambridge, 1862, 20s. |
| Glasgow, 1840, 15s. | Newcastle, 1863, 25s. |
| Plymouth, 1841, 12s. 6d. | Bath, 1864, 18s. |
| Manchester, 1842, 10s. 6d. | Birmingham, 1865, 25s. |
| Cork, 1843, 12s. | Nottingham, 1866, 24s. |
| York, 1844, 20s. | Dundee, 1867, 26s. |
| Cambridge, 1845, 12s. | Norwich, 1868, 25s. |
| Southampton, 1846, 15s. | Exeter, 1869, 22s. |
| Oxford, 1847, 18s. | Liverpool, 1870, 18s. |
| Swansea, 1848, 9s. | Edinburgh, 1871, 16s. |
| Birmingham, 1849, 10s. | Brighton, 1872, 34s. |
| Edinburgh, 1850, 15s. | Bradford, 1873, 26s. |
| Ipswich, 1851, 16s. 6d. | Belfast, 1874, 22s. |
| Helfast, 1852, 15s. | Bristol, 1875, 25s. |
| Hull, 1853, 10s. 6d. | Glasgow, 1876, 25s. |
| Liverpool, 1854, 18s. | |
- BROUGHTON (LORD)** Journey through Albania, Turkey in Europe and Asia, to Constantinople. Illustrations. 2 Vols. 8vo. 30s.
- Visits to Italy. 2 Vols. Post 8vo. 18s.
- BRUGSCH (PROFESSOR)** History of Egypt, from the earliest period. Derived from Monuments and Inscriptions. *New Edition.* Translated by H. DANBY SEYMOUR. 3 vols. 8vo. [In Preparation.]
- BUCKLEY (ARABELLA B.)** Short History of Natural Science, and the Progress of Discovery from the time of the Greeks to the present day, for Schools and young Persons. Illustrations. Post 8vo. 9s.
- BURGON (REV. J. W.)** Christian Gentleman; or, Memoir of Patrick Fraser Tytler. Post 8vo. 9s.
- Letters from Rome. Post 8vo. 12s.

- BURN (COL.)** Dictionary of Naval and Military Technical Terms, English and French—French and English. Crown 8vo. 15s.
- BUXTON'S (CHARLES)** Memoirs of Sir Thomas Fowell Buxton, Bart. With Selections from his Correspondence. Portrait. 8vo. 16s. *Popular Edition*. Fcap. 8vo. 5s.
- Ideas of the Day. 8vo. 5s.
- BURCKHARDT'S (DR. JACOB)** Cicerone; or Art Guide to Painting in Italy. Edited by REV. DR. A. VON ZAHN, and Translated from the German by MRS. A. CLOUGH. Post 8vo. 6s.
- BYLES' (SIR JOHN)** Foundations of Religion in the Mind and Heart of Man. Post 8vo. 6s.
- BYRON'S (LORD)** Life, Letters, and Journals. By THOMAS MOORE. *Cabinet Edition*. Plates. 6 Vols. Fcap. 8vo. 18s.; or One Volume, Portraits. Royal 8vo. 7s. 6d.
- and Poetical Works. *Popular Edition*. Portraits. 2 vols. Royal 8vo. 15s.
- Poetical Works. *Library Edition*. Portrait. 6 Vols. 8vo. 45s.
- *Cabinet Edition*. Plates. 10 Vols. 12mo. 30s.
- *Pocket Edition*. 8 Vols. 24mo. 21s. *In a case*.
- *Popular Edition*. Plates. Royal 8vo. 7s. 6d.
- *Pearl Edition*. Crown 8vo. 2s. 6d.
- Childe Harold. With 80 Engravings. Crown 8vo. 12s.
- 16mo. 2s. 6d.
- Vignettes. 16mo. 1s.
- Portrait. 16mo. 6d.
- Tales and Poems. 24mo. 2s. 6d.
- Miscellaneous. 2 Vols. 24mo. 5s.
- Dramas and Plays. 2 Vols. 24mo. 5s.
- Don Juan and Beppo. 2 Vols. 24mo. 5s.
- Beauties. Poetry and Prose. Portrait. Fcap. 8vo. 3s. 6d.
- BUTTMAN'S** Lexilogus; a Critical Examination of the Meaning of numerous Greek Words, chiefly in Homer and Hesiod. By Rev. J. R. FISHLAKE. 8vo. 12s.
- Irregular Greek Verbs. With all the Tenses extant—their Formation, Meaning, and Usage, with Notes, by Rev. J. R. FISHLAKE. Post 8vo. 6s.
- CALLCOTT (LADY)**. Little Arthur's History of England. *New Edition, brought down to 1872*. With Woodcuts. Fcap. 8vo. 1s. 6d.
- CARNARVON (LORD)**. Portugal, Galicia, and the Basque Provinces. Post 8vo. 3s. 6d.
- CARTWRIGHT (W. C.)**. The Jesuits: their Constitution and Teaching. An Historical Sketch. 8vo. 9s.
- CASTLEREAGH (THE)** DESPATCHES, from the commencement of the official career of Viscount Castlereagh to the close of his life. 12 Vols. 8vo. 14s. each.
- CAMPBELL (LORD)**. Lord Chancellors and Keepers of the Great Seal of England. From the Earliest Times to the Death of Lord Eldon in 1838. 10 Vols. Crown 8vo. 6s. each.
- Chief Justices of England. From the Norman Conquest to the Death of Lord Tenterden. 4 Vols. Crown 8vo. 6s. each.

- CAMPBELL (LORD). Lives of Lyndhurst and Brougham. 8vo. 16s.
 ——— Shakespeare's Legal Acquirements. 8vo. 5s. 6d.
 ——— Lord Bacon. Fcap. 8vo. 2s. 6d.
- (SIR GEORGE) India as it may be: an Outline of a proposed Government and Policy. 8vo. 12s.
 ——— Handy-Book on the Eastern Question; being a Very Recent View of Turkey. With Map. Post 8vo. 8s.
 ——— (THOS.) Essay on English Poetry. With Short Lives of the British Poets. Post 8vo. 3s. 6d.
- CAVALCASELLE AND CROWE'S History of Painting in NORTH ITALY, from the 14th to the 16th Century. With Illustrations. 2 Vols. 8vo. 42s.
- Early Flemish Painters, their Lives and Works. Illustrations. Post 8vo. 10s. 6d.; or Large Paper, 8vo. 15s.
- Life and Times of Titian, with some Account of his Family. With Portrait and Illustrations. 2 vols. 8vo. 42s.
- CESNOLA (GEN. L. P. DI). Cyprus; its Ancient Cities, Tombs, and Temples. A Narrative of Researches and Excavations during Ten Years' Residence in that Island. With numerous Illustrations. Medium 8vo. [In Preparation.]
- CHILD (G. CHAPLIN, M.D.). Benedicite; or, Song of the Three Children; being Illustrations of the Power, Beneficence, and Design manifested by the Creator in his works. Post 8vo. 6s.
- CHISHOLM (MRS.). Perils of the Polar Seas; True Stories of Arctic Discovery and Adventure. Illustrations. Post 8vo. 6s.
- CHURTON (ARCHDEACON). Poetical Remains, Translations and Imitations. Portrait. Post 8vo. 7s. 6d.
- New Testament. Edited with a Plain Practical Commentary for Families and General Readers. With 100 Panoramic and other Views, from Sketches made on the Spot. 2 vols. 8vo. 21s.
- CICERO'S LIFE AND TIMES. His Character as a Statesman, Orator, and Friend, with a Selection from his Correspondence and Orations. By WILLIAM FORSTH. With Illustrations. 8vo. 10s. 6d.
- CLARK (SIR JAMES). Memoir of Dr. John Conolly. Comprising a Sketch of the Treatment of the Insane in Europe and America. With Portrait. Post 8vo. 10s. 6d.
- CLIVE'S (LORD) Life. By REV. G. R. GLAIG. Post 8vo. 3s. 6d.
- CLODE (C. M.). Military Forces of the Crown; their Administration and Government. 2 Vols. 8vo. 21s. each.
- Administration of Justice under Military and Martial Law, as applicable to the Army, Navy, Marine, and Auxillary Forces. 8vo. 12s.
- CHURCH (THE) & THE AGE. Essays on the Principles and Present Position of the Anglican Church. By various Authors. 2 vols. 8vo. 26s.
- COLCHESTER (THE) Papers. The Diary and Correspondence of Charles Abbott, Lord Colchester, Speaker of the House of Commons. 1802-1817. Portrait. 3 Vols. 8vo. 42s.
- COLERIDGE'S (SAMUEL TAYLOR) Table-Talk. Portrait. 12mo. 3s. 6d.
- COLLINGWOOD (CUTHBERT). Rambles of a Naturalist on the Shores and Waters of the China Sea. With Illustrations. 8vo. 16s.
- COLONIAL LIBRARY. [See Home and Colonial Library.]

- COMPANIONS FOR THE DEVOUT LIFE.** Lectures delivered in St. James's Church. 1st Series, 1875. 2nd Series, 1876. New Edition in 1 vol., post 8vo. [*In the Press.*]
- COOK (Canon).** Sermons Preached at Lincoln's Inn. 8vo. 9s.
- COOKE (E. W.).** Leaves from my Sketch-Book. Being a selection from sketches made during many tours. 25 Plates. Small folio. 31s. 6d.
- A Second Series of Leaves from my Sketch Book. Consisting chiefly of Views in Egypt and the East. With Descriptive Text. Small folio. [*In the Press.*]
- COOKERY (MODERN DOMESTIC).** Founded on Principles of Economy and Practical Knowledge. By a Lady. Woodcuts. Fcap. 8vo. 5s.
- COOPER (T. T.).** Travels of a Pioneer of Commerce on an Overland Journey from China towards India. Illustrations. 8vo. 16s.
- CORNWALLIS (THE)** Papers and Correspondence during the American War,—Administrations in India,—Union with Ireland, and Peace of Amiens. 3 Vols. 8vo. 63s.
- COWPER'S (COURTESY) Diary** while Lady of the Bedchamber to Caroline, Princess of Wales, 1714—20. Portrait. 8vo. 10s. 6d.
- CRABBE (REV. GEORGE).** Life and Poetical Works. With Illustrations. Royal 8vo. 7s.
- CRAWFORD & BALCARRES (Earl of).** Etruscan Inscriptions. Analyzed, Translated, and Commented upon. 8vo. 12s.
- *Argo*; or the Quest of the Golden Fleece. A Metrical Tale, in Ten Books. 8vo. 10s. 6d.
- CROKER (J. W.).** Progressive Geography for Children. 18mo. 1s. 6d.
- Stories for Children, Selected from the History of England. Woodcuts. 16mo. 2s. 6d.
- Boswell's Life of Johnson. Including the Tour to the Hebrides. *Seventh Edition.* Portraits. 8vo. 12s.
- Early Period of the French Revolution. 8vo. 15s.
- Historical Essay on the Guillotine. Fcap. 8vo. 1s.
- CROWE AND CAVALCASELLE.** Lives of the Early Flemish Painters. Woodcuts. Post 8vo, 10s. 6d.; or Large Paper, 8vo. 15s.
- History of Painting in North Italy, from 14th to 16th Century. Derived from Researches into the Works of Art in that Country. With Illustrations. 2 Vols. 8vo. 42s.
- Life and Times of Titian, with some Account of his Family, chiefly from new and unpublished records. With Portrait and Illustrations. 2 vols. 8vo. 42s.
- CUMMING (R. GORDON).** Five Years of a Hunter's Life in the Far Interior of South Africa. Woodcuts. Post 8vo. 6s.
- CUNYNGHAME (SIR ARTHUR).** Travels in the Eastern Caucasus, on the Caspian and Black Seas, in Daghestan and the Frontiers of Persia and Turkey. With Map and Illustrations. 8vo. 18s.
- CURTIUS' (PROFESSOR) Student's Greek Grammar, for the Upper Forms.** Edited by DR. WM. SMITH. Post 8vo. 6s.
- Elucidations of the above Grammar. Translated by EVELYN ABBOT. Post 8vo. 7s. 6d.
- Smaller Greek Grammar for the Middle and Lower Forms. Abridged from the larger work. 12mo. 2s. 6d.
- Accidence of the Greek Language. Extracted from the above work. 12mo. 2s. 6d.
- Principles of Greek Etymology. Translated by A. S. WILKINS, M.A., and E. B. ENGLAND, B.A. 2 vols. 8vo. 15s. each.

- CURZON (HON. ROBERT).** Visits to the Monasteries of the Levant. Illustrations. Post 8vo. 7s. 6d.
- CUST (GENERAL).** Warriors of the 17th Century—The Thirty Years' War. 2 Vols. 18s. Civil Wars of France and England. 2 Vols. 16s. Commanders of Fleets and Armies. 2 Vols. 18s.
- Annals of the Wars—18th & 19th Century, 1700—1815. With Maps. 9 Vols. Post 8vo. 6s. each.
- DAVIS (NATHAN).** Ruined Cities of Numidia and Carthagina. Illustrations. 8vo. 16s.
- DAVY (SIR HUMPHRY).** Consolations in Travel; or, Last Days of a Philosopher. Woodcuts. Fcap. 8vo. 3s. 6d.
- Salmonia; or, Days of Fly Fishing. Woodcuts. Fcap. 8vo. 3s. 6d.
- DARWIN (CHARLES).** Journal of a Naturalist during a Voyage round the World. Crown 8vo. 9s.
- Origin of Species by Means of Natural Selection; or, the Preservation of Favoured Races in the Struggle for Life. Crown 8vo. 7s. 6d.
- Variation of Animals and Plants under Domestication. With Illustrations. 2 Vols. Crown 8vo. 18s.
- Descent of Man, and Selection in Relation to Sex. With Illustrations. Crown 8vo. 9s.
- Expressions of the Emotions in Man and Animals. With Illustrations. Crown 8vo. 12s.
- Various Contrivances by which Orchids are Fertilized by Insects. Woodcuts. Crown 8vo. 9s.
- Movements and Habits of Climbing Plants. Woodcuts. Crown 8vo. 6s.
- Insectivorous Plants. Woodcuts. Crown 8vo. 14s.
- Effects of Cross and Self-Fertilization in the Vegetable Kingdom. Crown 8vo. 12s.
- Facts and Argument for Darwin. By FRITZ MULLER. Translated by W. S. DALLAS. Woodcuts. Post 8vo. 6s.
- Different Forms of Flowers on Plants of the same Species. Crown 8vo. 10s. 6d.
- DE COSSON (E. A.).** The Cradle of the Blue Nile; a Journey through Abyssinia and Soudan, and a residence at the Court of King John of Ethiopia. Map and Illustrations. 2 vols. Post 8vo. 21s.
- DELEPIERRE (OCTAVE).** History of Flemish Literature. 8vo. 9s.
- DENNIS (GEORGE).** The Cities and Cemeteries of Etruria. An entirely new Edition, with a new Chapter on Etrurian Bologna. Numerous Illustrations. 2 vols. 8vo. [In the Press.]
- DENT (EMMA).** Annals of Winchcombe and Sudeley. With 120 Portraits, Plates and Woodcuts. 4to. 42s.
- DERBY (EARL OF).** Iliad of Homer rendered into English Blank Verse. 10th Edition. With Portrait. 2 Vols. Post 8vo. 10s.
- DERRY (BISHOP OF).** Witness of the Psalms to Christ and Christianity. The Bampton Lectures for 1878. 8vo. 10s. 6d.
- DEUTSCH (EMANUEL).** Talmud, Islam, The Targums and other Literary Remains. 8vo. 12s.
- DILKE (SIR C. W.).** Papers of a Critic. Selected from the Writings of the late CHAS. WENTWORTH DILKE. With a Biographical Sketch. 2 Vols. 8vo. 24s.

- DOG-BREAKING**, with Odds and Ends for those who love the Dog and Gun. By GEN. HUTCHINSON. With 40 Illustrations. Crown 8vo. 7s. 6d.
- DOMESTIC MODERN COOKERY**. Founded on Principles of Economy and Practical Knowledge, and adapted for Private Families. Woodcuts. Fcap. 8vo. 5s.
- DOUGLASS'S (SIR HOWARD) Life and Adventures**. Portrait. 8vo. 15s.
- **Theory and Practice of Gunnery**. Plates. 8vo. 21s.
- **Construction of Bridges and the Passage of Rivers in Military Operations**. Plates. 8vo. 21s.
- **(WM.) Horse-Shoeing; As it Is, and As it Should be**. Illustrations. Post 8vo. 7s. 6d.
- DRAKE'S (SIR FRANCIS) Life, Voyages, and Exploits, by Sea and Land**. By JOHN BARROW. Post 8vo. 2s.
- DRINKWATER (JOHN)**. History of the Siege of Gibraltar, 1779-1783. With a Description and Account of that Garrison from the Earliest Periods. Post 8vo. 2s.
- DUCANGE'S MEDIEVAL LATIN-ENGLISH DICTIONARY**. Translated and Edited by REV. E. A. DAYMAN and J. H. HESSELS. Small 4to. [In preparation.]
- DU CHAILLU (PAUL B.) EQUATORIAL AFRICA**, with Accounts of the Gorilla, the Nest-building Ape, Chimpanzee, Crocodile, &c. Illustrations. 8vo. 21s.
- **Journey to Ashango Land; and Further Penetration into Equatorial Africa**. Illustrations. 8vo. 21s.
- DUFFERIN (LORD)**. Letters from High Latitudes; a Yacht Voyage to Iceland, Jan Mayen, and Spitzbergen. Woodcuts. Post 8vo. 7s. 6d.
- DUNCAN (MAJOR)**. History of the Royal Artillery. Compiled from the Original Records. With Portraits. 2 Vols. 8vo. 30s.
- **The English in Spain; or, The Story of the Civil War between Christians and Carlists in 1834 and 1840**. Compiled from the Letters, Journals, and Reports of the British Commissioners with Queen Isabella's Armies. With Plates. 8vo.
- EASTLAKE (SIR CHARLES)**. Contributions to the Literature of the Fine Arts. With Memoir of the Author, and Selections from his Correspondence. By LADY EASTLAKE. 2 Vols. 8vo. 24s.
- EDWARDS' (W. H.) Voyage up the River Amazons, including a Visit to Para**. Post 8vo. 2s.
- EIGHT MONTHS AT ROME**, during the Vatican Council, with a Daily Account of the Proceedings. By POMRONIO LATO. Translated from the Original. 8vo. 12s.
- ELDON'S (LORD) Public and Private Life, with Selections from his Correspondence and Diaries**. By HORACE TWISS. Portrait. 2 Vols. Post 8vo. 21s.
- ELGIN'S (LORD) Letters and Journals**. Edited by THEODORE WALBOND. With Preface by Dean Stanley. 8vo. 14s.
- ELLESMERE (LORD)**. Two Sieges of Vienna by the Turks. Translated from the German. Post 8vo. 2s.
- ELLIS (W.) Madagascar Revisited**. Setting forth the Persecutions and Heroic Sufferings of the Native Christians. Illustrations. 8vo. 16s.
- **Memoir**. By HIS SON. With his Character and Work. By REV. HENRY ALLEN, D.D. Portrait. 8vo. 10s. 6d.
- **(ROBINSON) Poems and Fragments of Catullus**. 16mo. 5s.

- ELPHINSTONE (HON. MOUNTSTUART).** History of India—the Hindoo and Mahomedan Periods. Edited by PROFESSOR COWELL. Map. 8vo. 18s.
- (H. W.) Patterns for Turning; Comprising Elliptical and other Figures cut on the Lath without the use of any Ornamental Chuck. With 70 Illustrations. Small 4to. 15s.
- ENGLAND.** See **CALLCOTT, CROKER, HUME, MARKHAM, SMITH,** and **STANHOPE.**
- ESSAYS ON CATHEDRALS.** With an Introduction. By DEAN HOWSON. 8vo. 12s.
- ELZE (KARL).** Life of Lord Byron. With a Critical Essay on his Place in Literature. Translated from the German. With Portrait. 8vo. 16s.
- FERGUSON (JAMES).** History of Architecture in all Countries from the Earliest Times. With 1,600 Illustrations. 4 Vols. Medium 8vo. Vol. I. & II. Ancient and Mediæval. 63s. Vol. III. Indian and Eastern. 42s. Vol. IV. Modern. 31s. 6d.
- Rude Stone Monuments in all Countries; their Age and Uses. With 230 Illustrations. Medium 8vo. 24s.
- Holy Sepulchre and the Temple at Jerusalem. Woodcuts. 8vo. 7s. 6d.
- FLEMING (PROFESSOR).** Student's Manual of Moral Philosophy. With Quotations and References. Post 8vo. 7s. 6d.
- FLOWER GARDEN.** By REV. THOS. JAMES. Fcap. 8vo. 1s.
- FORD (RICHARD).** Gatherings from Spain. Post 8vo. 3s. 6d.
- FORSYTH (WILLIAM).** Life and Times of Cicero. With Selections from his Correspondence and Orations. Illustrations. 8vo. 10s. 6d.
- Hortensius; an Historical Essay on the Office and Duties of an Advocate. Illustrations. 8vo. 12s.
- History of Ancient Manuscripts. Post 8vo. 2s. 6d.
- Novels and Novelists of the 18th Century, in Illustration of the Manners and Morals of the Age. Post 8vo. 10s. 6d.
- The Slavonic Provinces South of the Danube; a Sketch of their History and Present State. Map. Post 8vo. 5s.
- FORTUNE (ROBERT).** Narrative of Two Visits to the Tea Countries of China, 1843-52. Woodcuts. 2 Vols. Post 8vo. 18s.
- FORSTER (JOHN).** The Early Life of Jonathan Swift. 1667-1711. With Portrait. 8vo. 15s.
- FOSS (EDWARD).** Biographia Juridica, or Biographical Dictionary of the Judges of England, from the Conquest to the Present Time, 1066-1870. Medium 8vo. 21s.
- FRANCE (HISTORY OF).** See **MARKHAM—SMITH—Student's.**
- FRENCH (THE) in Algiers; The Soldier of the Foreign Legion— and the Prisoners of Abd-el-Kadr.** Translated by Lady DUFF GORDON. Post 8vo. 2s.
- FRERE (SIR BARTLE).** Indian Missions. Small 8vo. 2s. 6d.
- Eastern Africa as a field for Missionary Labour. With Map. Crown 8vo. 5s.
- Bengal Famine. How it will be Met and How to Prevent Future Famines in India. With Maps. Crown 8vo. 5s.

- GALTON (FRANCIS).** Art of Travel; or, Hints on the Shifts and Contrivances available in Wild Countries. Woodcuts. Post 8vo. 7s. 6d.
- GEOGRAPHICAL SOCIETY'S JOURNAL.** (*Published Yearly.*)
- GEORGE (ERNEST).** The Mosel; a Series of Twenty Etchings, with Descriptive Letterpress. Imperial 4to. 42s.
- Loire and South of France; a Series of Twenty Etchings, with Descriptive Text. Folio. 42s.
- GERMANY (HISTORY OF).** See **MARKHAM.**
- GIBBON (EDWARD).** History of the Decline and Fall of the Roman Empire. Edited by MILMAN and GUIZOT. Edited, with Notes, by Dr. WM. SMITH. Maps. 8 Vols. 8vo. 80s.
- (The Student's Gibbon); Being an Epitome of the above work, incorporating the Researches of Recent Commentators. By Dr. WM. SMITH. Woodcuts. Post 8vo. 7s. 6d.
- GIFFARD (EDWARD).** Deeds of Naval Daring; or, Anecdotes of the British Navy. Fcap. 8vo. 3s. 6d.
- GLADSTONE (W. E.).** Financial Statements of 1853, 1860, 63-65. 8vo. 12s.
- Rome and the Newest Fashions in Religion. Three Tracts. 8vo. 7s. 6d.
- GLEIG (G. R.).** Campaigns of the British Army at Washington and New Orleans. Post 8vo. 2s.
- Story of the Battle of Waterloo. Post 8vo. 3s. 6d.
- Narrative of Sale's Brigade in Afghanistan. Post 8vo. 2s.
- Life of Lord Clive. Post 8vo. 3s. 6d.
- Sir Thomas Munro. Post 8vo. 3s. 6d.
- GLYNNE (SIR STEPHEN).** Notes on the Churches of Kent. With Illustrations. 8vo. [*In Preparation.*]
- GOLDSMITH'S (OLIVER) Works.** Edited with Notes by PETER CUNNINGHAM. Vignettes. 4 Vols. 8vo. 80s.
- GORDON (SIR ALEX.).** Sketches of German Life, and Scenes from the War of Liberation. Post 8vo. 3s. 6d.
- (LADY DUFF) Amber-Witch: A Trial for Witchcraft. Post 8vo. 2s.
- French in Algiers. 1. The Soldier of the Foreign Legion. 2. The Prisoners of Abd-el-Kadr. Post 8vo. 2s.
- GRAMMARS.** See **CURTIVS; HALL; HUTTON; KING EDWARD; ATTHIX; MARTNER; SMITH.**
- GREECE (HISTORY OF).** See **GROTE—SMITH—Student.**
- GREY (EARL).** Parliamentary Government and Reform; with Suggestions for the Improvement of our Representative System. *Second Edition.* 8vo. 9s.
- GUIZOT (M.).** Meditations on Christianity. 3 Vols. Post 8vo. 30s.
- GROTE (GEOGE).** History of Greece. From the Earliest Times to the close of the generation contemporary with the death of Alexander the Great. *Library Edition.* Portrait, Maps, and Plans. 10 Vols. 8vo. 120s. *Cabinet Edition.* Portrait and Plans. 12 Vols. Post 8vo. 6s. each.
- PLATO, and other Companions of Socrates. 3 Vols. 8vo. 45s.

- GROTE (GEORGE). ARISTOTLE.** 2 Vols. 8vo. 32s.
 ——— **Minor Works.** With Critical Remarks on his Intellectual Character, Writings, and Speeches. By ALEX. BAIN, LL.D. Portrait. 8vo. 14s.
 ——— **Fragments on Ethical Subjects.** Being a Selection from his Posthumous Papers. With an Introduction. By ALEXANDER BAIN, M.A. 8vo. 7s.
 ——— **Letters on the Politics of Switzerland in 1847.** 6s.
 ——— **Personal Life.** Compiled from Family Documents, Private Memoranda, and Original Letters to and from Various Friends. By Mrs. GROTE. Portrait. 8vo. 12s.
- HALL (T. D.) AND Dr. WM. SMITH'S School Manual of English Grammar.** With Copious Exercises. 12mo. 3s. 6d.
 ——— **Primary English Grammar for Elementary Schools.** Based on the above work. 16mo. 1s.
 ——— **Child's First Latin Book,** including a Systematic Treatment of the New Pronunciation, and a full Praxis of Nouns, Adjectives, and Pronouns. 16mo. 1s. 6d.
- HALLAM (HENRY). Constitutional History of England, from the Accession of Henry the Seventh to the Death of George the Second.** *Library Edition.* 3 Vols. 8vo. 30s. *Cabinet Edition,* 3 Vols. Post 8vo. 12s.
 ——— **Student's Edition of the above work.** Edited by WM. SMITH, D.C.L. Post 8vo. 7s. 6d.
 ——— **History of Europe during the Middle Ages.** *Library Edition.* 3 Vols. 8vo. 30s. *Cabinet Edition,* 3 Vols. Post 8vo. 12s.
 ——— **Student's Edition of the above work.** Edited by WM. SMITH, D.C.L. Post 8vo. 7s. 6d.
 ——— **Literary History of Europe, during the 15th, 16th and 17th Centuries.** *Library Edition.* 3 Vols. 8vo. 36s. *Cabinet Edition.* 4 Vols. Post 8vo. 18s.
 ——— **(ARTHUR) Literary Remains; in Verse and Prose.** Portrait. Fcap. 8vo. 3s. 6d.
- HAMILTON (GEN. SIR F. W.). History of the Grenadier Guards.** From Original Documents in the Rolls' Records, War Office, Regimental Records, &c. With Illustrations. 3 Vols. 8vo. 63s.
- HART'S ARMY LIST.** (*Published Quarterly and Annually.*)
- HAY (SIR J. H. DRUMMOND). Western Barbary, its Wild Tribes and Savage Animals.** Post 8vo. 2s.
- HEAD (SIR FRANCIS). Royal Engineer.** Illustrations. 8vo. 12s.
 ——— **Life of Sir John Burgoyne.** Post 8vo. 1s.
 ——— **Rapid Journeys across the Pampas.** Post 8vo. 2s.
 ——— **Bubbles from the Brunnen of Naassau.** Illustrations. Post 8vo. 7s. 6d.
 ——— **Stokers and Pokers; or, the London and North Western Railway.** Post 8vo. 2s.
 ——— **(SIR EDMUND) Shall and Will; or, Future Auxiliary Verbs.** Fcap. 8vo. 4s.
- HEBER'S (BISHOP) Journals in India.** 2 Vols. Post 8vo. 7s.
 ——— **Poetical Works.** Portrait. Fcap. 8vo. 3s. 6d.
 ——— **Hymns adapted to the Church Service.** 16mo. 1s. 6d.

FOREIGN HANDBOOKS.

- HAND-BOOK—TRAVEL-TALK.** English, French, German, and Italian. 16mo. 3s. 6d.
- **HOLLAND AND BELGIUM.** Map and Plans. Post 8vo. 6s.
- **NORTH GERMANY and THE RHINE,**—The Black Forest, the Hartz, Thüringerwald, Saxon Switzerland, Rügen, the Giant Mountains, Taunus, Odenwald, Elsass, and Lothringen. Map and Plans. Post 8vo. 10s.
- **SOUTH GERMANY,**—Wurtemberg, Bavaria, Austria, Styria, Salzburg, the Austrian and Bavarian Alps, Tyrol, Hungary, and the Danube, from Ulm to the Black Sea. Map. Post 8vo. 10s.
- **PAINTING.** German, Flemish, and Dutch Schools. Illustrations. 2 Vols. Post 8vo. 24s.
- **LIVES OF EARLY FLEMISH PAINTERS.** By CROWE and CAVALCASSELLE. Illustrations. Post 8vo. 10s. 6d.
- **SWITZERLAND,** Alps of Savoy, and Piedmont. Maps. Post 8vo. 9s.
- **FRANCE,** Part I. Normandy, Brittany, the French Alps, the Loire, the Seine, the Garonne, and Pyrenees. Post 8vo. 7s. 6d.
- Part II. Central France, Auvergne, the Cevennes, Burgundy, the Rhone and Saone, Provence, Nimes, Arles, Marseilles, the French Alps, Alsace, Lorraine, Champagne, &c. Maps. Post 8vo. 7s. 6d.
- **MEDITERRANEAN ISLANDS**—Malta, Corsica, Sardinia, and Sicily. Maps. Post 8vo. [In the Press.]
- **ALGERIA.** Algiers, Constantine, Oran, the Atlas Range. Map. Post 8vo. 9s.
- **PARIS,** and its Environs. Map. 16mo. 3s. 6d.
- *. * MURRAY'S PLAN OF PARIS, mounted on canvas. 3s. 6d.
- **SPAIN,** Madrid, The Castiles, The Basque Provinces, Leon, The Asturias, Galicia, Estremadura, Andalusia, Ronda, Granada, Murcia, Valencia, Catalonia, Aragon, Navarre, The Balearic Islands, &c. &c. Maps. 2 Vols. Post 8vo. 24s.
- **PORTUGAL,** LISBON, Porto, Cintra, Mafra, &c. Map. Post 8vo. 12s.
- **NORTH ITALY,** Turin, Milan, Cremona, the Italian Lakes, Bergamo, Brescia, Verona, Mantua, Vicenza, Padua, Ferrara, Bologna, Ravenna, Rimini, Piacenza, Genoa, the Riviera, Venice, Parma, Modena, and Romagna. Map. Post 8vo. 10s.
- **CENTRAL ITALY,** Florence, Lucca, Tuscany, The Marches, Umbria, and late Patrimony of St. Peter's. Map. Post 8vo. 10s.
- **ROME and its ENVIRONS.** Map. Post 8vo. 10s.
- **SOUTH ITALY,** Two Sicilies, Naples, Pompeii, Herculaneum, and Vesuvius. Map. Post 8vo. 10s.
- **KNAPSACK GUIDE TO ITALY.** 16mo.
- **PAINTING.** The Italian Schools. Illustrations. 2 Vols. Post 8vo. 30s.
- **LIVES OF ITALIAN PAINTERS, FROM CIMABUE to BASSANO.** By Mrs. JAMISON. Portraits. Post 8vo. 12s.
- **NORWAY,** Christiania, Bergen, Trondhjem. The Fjelds and Fjords. Map. Post 8vo. 9s.
- **SWEDEN,** Stockholm, Upsala, Gothenburg, the Shores of the Baltic, &c. Post 8vo. 6s.
- **DENMARK,** Sleswig, Holstein, Copenhagen, Jutland, Iceland. Map. Post 8vo. 6s.

HAND-BOOK—RUSSIA, St. PETERSBURG, MOSCOW, POLAND, and FINLAND. Maps. Post 8vo. 18s.

GREECE, the Ionian Islands, Continental Greece, Athens, the Peloponnesus, the Islands of the Ægean Sea, Albania, Thessaly, and Macedonia. Maps. Post 8vo. 15s.

TURKEY IN ASIA—CONSTANTINOPLE, the Bosphorus, Dardanelles, Brousa, Plain of Troy, Crete, Cyprus, Smyrna, Ephesus, the Seven Churches, Coasts of the Black Sea, Armenia, Mesopotamia, &c. Maps. Post 8vo. 15s.

EGYPT, including Descriptions of the Course of the Nile through Egypt and Nubia, Alexandria, Cairo, and Thebes, the Suez Canal, the Pyramids, the Peninsula of Sinai, the Oases, the Fyoom, &c. Map. Post 8vo. 15s.

HOLY LAND—SYRIA, PALESTINE, Peninsula of Sinai, Edom, Syrian Deserts, Petra, Damascus, and Palmyra. Maps. Post 8vo. 20s. *.* Travelling Map of Palestine. In a case. 12s.

INDIA—BOMBAY AND MADRAS. Map. 2 Vols. Post 8vo. 12s. each.

ENGLISH HANDBOOKS.

HAND-BOOK—MODERN LONDON. Map. 16mo. 3s. 6d.

ENVIRONS OF LONDON within a circuit of 20 miles. 2 Vols. Crown 8vo. 21s.

EASTERN COUNTIES, Chelmsford, Harwich, Colchester, Maldon, Cambridge, Ely, Newmarket, Bury St. Edmunds, Ipswich, Woodbridge, Felixstowe, Lowestoft, Norwich, Yarmouth, Cromer, &c. Map and Plans. Post 8vo. 12s.

CATHEDRALS of Oxford, Peterborough, Norwich, Ely, and Lincoln. With 90 Illustrations. Crown 8vo. 18s.

KENT, Canterbury, Dover, Ramsgate, Sheerness, Rochester, Chatham, Woolwich. Map. Post 8vo. 7s. 6d.

SUSSEX, Brighton, Chichester, Worthing, Hastings, Lewes, Arundel, &c. Map. Post 8vo. 6s.

SURREY AND HANTS, Kingston, Croydon, Reigate, Guildford, Dorking, Boxhill, Winchester, Southampton, New Forest, Portsmouth, and ISLE OF WIGHT. Maps. Post 8vo. 10s.

BERKS, BUCKS, AND OXON, Windsor, Eton, Reading, Aylesbury, Uxbridge, Wycombe, Henley, the City and University of Oxford, Blenheim, and the Descent of the Thames. Map. Post 8vo. 7s. 6d.

WILTS, DORSET, AND SOMERSET, Salisbury, Chippenham, Weymouth, Sherborne, Wells, Bath, Bristol, Taunton, &c. Map. Post 8vo. 10s.

DEVON AND CORNWALL, Exeter, Ilfracombe, Linton, Sidmouth, Dawlish, Teignmouth, Plymouth, Devonport, Torquay, Launceston, Truro, Penzance, Falmouth, the Lizard, Land's End, &c. Maps. Post 8vo. 12s.

CATHEDRALS of Winchester, Salisbury, Exeter, Wells, Chichester, Rochester, Canterbury, and St. Albans. With 130 Illustrations. 2 Vols. Crown 8vo. 36s. St. Albans separately, crown 8vo. 6s.

GLOUCESTER, HEREFORD, AND WORCESTER, Cirencester, Cheltenham, Stroud, Tewkesbury, Leominster, Ross, Malvern, Kidderminster, Dudley, Bromsgrove, Evesham. Map. Post 8vo. 8s.

CATHEDRALS of Bristol, Gloucester, Hereford, Worcester, and Lichfield. With 50 Illustrations. Crown 8vo. 16s.

LIST OF WORKS

... ..

... ..

... ..

... ..

... ..

... ..

... ..

... ..

... ..

... ..

... ..

... ..

... ..

... ..

... ..

... ..

... ..



HOME AND COLONIAL LIBRARY. A Series of Works adapted for all circles and classes of Readers, having been selected for their acknowledged interest, and ability of the Authors. Post 8vo. Published at 2s. and 3s. 6d. each, and arranged under two distinctive heads as follows:—

CLASS A.**HISTORY, BIOGRAPHY, AND HISTORIC TALES.**

- | | |
|--|---|
| <p>1. SIEGE OF GIBRALTAR. y
JOHN DRINKWATER. 2s.</p> <p>2. THE AMBER-WITCH. By
LADY DUFF GORDON. 2s.</p> <p>3. CROMWELL AND BUNYAN.
By ROBERT SOUTHEY. 2s.</p> <p>4. LIFE OF SIR FRANCIS DRAKE.
By JOHN BARROW. 2s.</p> <p>5. CAMPAIGNS AT WASHINGTON.
By REV. G. R. GLEIG. 2s.</p> <p>6. THE FRENCH IN ALGIERS.
By LADY DUFF GORDON. 2s.</p> <p>7. THE FALL OF THE JESUITS.
2s.</p> <p>8. LIVONIAN TALES. 2s.</p> <p>9. LIFE OF CONDÉ. By LORD MAHON. 3s. 6d.</p> <p>10. SALE'S BRIGADE. By REV. G. R. GLEIG. 2s.</p> | <p>11. THE SIEGES OF VIENNA.
By LORD ELLESMERE. 2s.</p> <p>12. THE WAYSIDE CROSS. By
CAPT. MILMAN. 2s.</p> <p>13. SKETCHES OF GERMAN LIFE.
By SIR A. GORDON. 3s. 6d.</p> <p>14. THE BATTLE OF WATERLOO.
By REV. G. R. GLEIG. 3s. 6d.</p> <p>15. AUTOBIOGRAPHY OF STEPFENS. 2s.</p> <p>16. THE BRITISH POETS. By
THOMAS CAMPBELL. 3s. 6d.</p> <p>17. HISTORICAL ESSAYS. By
LORD MAHON. 3s. 6d.</p> <p>18. LIFE OF LORD CLIVE. By
REV. G. R. GLEIG. 3s. 6d.</p> <p>19. NORTH - WESTERN RAILWAY. By SIR F. B. HEAD. 2s.</p> <p>20. LIFE OF MUNRO. By REV. G. R. GLEIG. 3s. 6d.</p> |
|--|---|

CLASS B.**VOYAGES, TRAVELS, AND ADVENTURES.**

- | | |
|---|--|
| <p>1. BIBLE IN SPAIN. By GEORGE BORBOW. 3s. 6d.</p> <p>2. GYPSIES OF SPAIN. By GEORGE BORBOW. 3s. 6d.</p> <p>3 & 4. JOURNALS IN INDIA. By BISHOP HESER. 2 Vols. 7s.</p> <p>5. TRAVELS IN THE HOLY LAND. By ISBY and MANGLES. 2s.</p> <p>6. MOROCCO AND THE MOORS. By J. DRUMMOND HAY. 2s.</p> <p>7. LETTERS FROM THE BALTIC. By a LADY.</p> <p>8. NEW SOUTH WALES. By MRS. MEREDITH. 2s.</p> <p>9. THE WEST INDIES. By M. G. LEWIS. 2s.</p> <p>10. SKETCHES OF PERSIA. By SIR JOHN MALCOLM. 3s. 6d.</p> <p>11. MEMOIRS OF FATHER RIPA. 2s.</p> <p>12 & 13. TYPEE AND OMOO. By HERMAN MELVILLE. 2 Vols. 7s.</p> <p>14. MISSIONARY LIFE IN CANADA. By REV. J. ABBOTT. 2s.</p> | <p>15. LETTERS FROM MADRAS. By a LADY. 2s.</p> <p>16. HIGHLAND SPORTS. By CHARLES ST. JOHN. 3s. 6d.</p> <p>17. PAMPAS JOURNEYS. By SIR F. B. HEAD. 2s.</p> <p>18. GATHERINGS FROM SPAIN. By RICHARD FORD. 3s. 6d.</p> <p>19. THE RIVER AMAZON. By W. H. EDWARDS. 2s.</p> <p>20. MANNERS & CUSTOMS OF INDIA. By REV. C. AGLAND. 2s.</p> <p>21. ADVENTURES IN MEXICO. By G. F. RUXTON. 3s. 6d.</p> <p>22. PORTUGAL AND GALICIA. By LORD CARMARVON. 3s. 6d.</p> <p>23. BUSH LIFE IN AUSTRALIA. By REV. H. W. HAYGARTH. 2s.</p> <p>24. THE LIBYAN DESERT. By BAYLE ST. JOHN. 2s.</p> <p>25. SIERRA LEONE. By A LADY. 3s. 6d.</p> |
|---|--|

. Each work may be had separately.

- HOOK'S (THEODORE) Life.** By J. G. LOCKHART. Fcap. 8vo. 1s.
- HOPE (T. C.). ARCHITECTURE OF AHMEDABAD,** with Historical Sketch and Architectural Notes. With Maps, Photographs, and Woodcuts. 4to. 5l. 6s.
- (A. J. BERESFORD) **Worship in the Church of England.** 8vo. 9s., or, *Popular Selections from.* 8vo. 2s. 6d.
- HORACE; a New Edition of the Text.** Edited by DEAN MILMAN. With 100 Woodcuts. Crown 8vo. 7s. 6d.
- **Life of.** By DEAN MILMAN. Illustrations. 8vo. 9s.
- HOUGHTON'S (LORD) Monographs, Personal and Social.** With Portraits. Crown 8vo. 10s. 6d.
- **POETICAL WORKS. Collected Edition.** With Portrait. 2 Vols. Fcap. 8vo. 12s.
- HUME'S (The Student's) History of England, from the Invasion of Julius Caesar to the Revolution of 1688.** Corrected and continued to 1838. Woodcuts. Post 8vo. 7s. 6d.
- HUTCHINSON (GEN.) Dog Breaking, with Odds and Ends for those who love the Dog and the Gun.** With 40 Illustrations. 6th edition. 7s. 6d.
- HUTTON (H. E.). Principia Græca; an Introduction to the Study of Greek.** Comprehending Grammar, Delectus, and Exercise-book, with Vocabularies. *Sixth Edition.* 12mo. 3s. 6d.
- IRBY AND MANGLES' Travels in Egypt, Nubia, Syria, and the Holy Land.** Post 8vo. 2s.
- JACOBSON (BISHOP). Fragmentary Illustrations of the History of the Book of Common Prayer; from Manuscript Sources (Bishop SANDERSON and Bishop WREN).** 8vo. 5s.
- JAMES' (REV. THOMAS) Fables of Æsop. A New Translation, with Historical Preface.** With 100 Woodcuts by TERNIER and WOLFF. Post 8vo. 2s. 6d.
- JAMESON (MRS.). Lives of the Early Italian Painters— and the Progress of Painting in Italy—Cimabue to Bassano.** With 50 Portraits. Post 8vo. 12s.
- JENNINGS (LOUIS J.). Field Paths and Green Lanes.** Being Country Walks, chiefly in Surrey and Sussex. With Illustrations. Post 8vo. [*In the Press.*]
- JERVIS (REV. W. H.). Gallican Church, from the Concordat of Bologna, 1516, to the Revolution.** With an Introduction. Portraits. 2 Vols. 8vo. 28s.
- JESSE (EDWARD). Gleanings in Natural History.** Fcp. 8vo. 3s. 6d.
- JEX-BLAKE (REV. T. W.). Life in Faith: Sermons Preached at Cheltenham and Rugby.** Fcap. 8vo. 3s. 6d.
- JOHNS' (REV. B. G.) Blind People; their Works and Ways.** With Sketches of the Lives of some famous Blind Men. With Illustrations. Post 8vo. 7s. 6d.
- JOHNSON'S (DR. SAMUEL) Life.** By James Boswell. Including the Tour to the Hebrides. Edited by MR. CROKER. *New Edition.* Portraits. 4 Vols. 8vo. [*In Preparation.*]
- **Lives of the most eminent English Poets, with Critical Observations on their Works.** Edited with Notes, Corrective and Explanatory, by PETER CUNNINGHAM. 3 vols. 8vo. 22s. 6d.
- JUNIUS' HANDWRITING Professionally investigated.** By Mr. CHABOT, Expert. With Preface and Collateral Evidence, by the Hon. EDWARD TWISLETON. With Facsimiles, Woodcuts, &c. 4to. £3 8s.

- KEN'S (BISHOP) Life.** By a **LAYMAN.** Portrait. 2 Vols. 8vo. 18s.
 Exposition of the Apostles' Creed. 16mo. 1s. 6d.
- KERR (ROBERT).** **GENTLEMAN'S HOUSE; OR, HOW TO PLAN ENGLISH RESIDENCES FROM THE PARSONAGE TO THE PALACE.** With Views and Plans. 8vo. 24s.
 Small Country House. A Brief Practical Discourse on the Planning of a Residence from 2000l. to 5000l. With Supplementary Estimates to 7000l. Post 8vo. 3s.
 Ancient Lights; a Book for Architects, Surveyors, Lawyers, and Landlords. 8vo. 5s. 6d.
 (R. MALCOLM) Student's Blackstone. A Systematic Abridgment of the entire Commentaries, adapted to the present state of the law. Post 8vo. 7s. 6d.
- KING EDWARD VIth's Latin Grammar.** 12mo. 3s. 6d.
 First Latin Book. 12mo. 2s. 6d.
- KING GEORGE IIIrd's Correspondence with Lord North, 1769-82.** Edited, with Notes and Introduction, by W. BODHAM DOWNE. 2 vols. 8vo. 32s.
- KING (R. J.).** Archaeology, Travel and Art; being Sketches and Studies, Historical and Descriptive. 8vo. 12s.
- KIRK (J. FOSTER).** History of Charles the Bold, Duke of Burgundy. Portrait. 3 Vols. 8vo. 45s.
- KIRKES' Handbook of Physiology.** Edited by W. MORREWF BAKER, F.R.C.S. 9th Edition. With 400 Illustrations. Post 8vo. 14s.
- KUGLER'S Handbook of Painting.—The Italian Schools.** Revised and Remodelled from the most recent Researches. By LADY EASTLAKE. With 140 Illustrations. 2 Vols. Crown 8vo. 30s.
 Handbook of Painting.—The German, Flemish, and Dutch Schools. Revised and in part re-written. By J. A. CROWE. With 60 Illustrations. 2 Vols. Crown 8vo. 24s.
- LANE (E. W.).** Account of the Manners and Customs of Modern Egyptians. With Illustrations. 2 Vols. Post 8vo. 12s
- LAWRENCE (SIR GEO.).** Reminiscences of Forty-three Years' Service in India; including Captivities in Cabul among the Afghans and among the Sikhs, and a Narrative of the Mutiny in Rajputana. Crown 8vo. 10s. 6d.
- LAYARD (A. H.).** Nineveh and its Remains. Being a Narrative of Researches and Discoveries amidst the Ruins of Assyria. With an Account of the Chaldean Christians of Kurdistan; the Yezedis, or Devil-worshippers; and an Enquiry into the Manners and Arts of the Ancient Assyrians. Plates and Woodcuts. 2 Vols. 8vo. 36s.
 * * * A POPULAR EDITION of the above work. With Illustrations. Post 8vo. 7s. 6d.
 Nineveh and Babylon; being the Narrative of Discoveries in the Ruins, with Travels in Armenia, Kurdistan and the Desert, during a Second Expedition to Assyria. With Map and Plates. 8vo. 21s.
 * * * A POPULAR EDITION of the above work. With Illustrations. Post 8vo. 7s. 6d.
- LEATHES' (STANLEY) Practical Hebrew Grammar.** With the Hebrew Text of Genesis i.—vi., and Psalms i.—vi. Grammatical Analysis and Vocabulary. Post 8vo. 7s. 6d.
- LENNEP (REV. H. J. VAN).** Missionary Travels in Asia Minor. With Illustrations of Biblical History and Archaeology. With Map and Woodcuts. 2 Vols. Post 8vo. 24s.
 Modern Customs and Manners of Bible Lands in Illustration of Scripture. With Coloured Maps and 300 Illustrations. 2 Vols. 8vo. 21s.

- LESLIE (C. R.). Handbook for Young Painters. With Illustrations. Post 8vo. 7s. 6d.
- Life and Works of Sir Joshua Reynolds. Portraits and Illustrations. 2 Vols. 8vo. 42s.
- LETO (POMFONIO). Eight Months at Rome during the Vatican Council. With a daily account of the proceedings. Translated from the original. 8vo. 12s.
- LETTERS FROM THE BALTIC. By a LADY. Post 8vo. 2s.
- MADRAS. By a LADY. Post 8vo. 2s.
- SIERRA LEONE. By a LADY. Post 8vo. 3s. 6d.
- LEVI (LEONE). History of British Commerce; and of the Economic Progress of the Nation, from 1763 to 1870. 8vo. 16s.
- LIDDELL (DEAN). Student's History of Rome, from the earliest Times to the establishment of the Empire. Woodcuts. Post 8vo. 7s. 6d.
- LLOYD (W. WATKISS). History of Sicily to the Athenian War; with Elucidations of the Sicilian Odes of Pindar. With Map. 8vo. 14s.
- LISPINGS from LOW LATITUDES; or, the Journal of the Hon. Impulsia Gushington. Edited by LORD DUFFERIN. With 24 Plates. 4to. 21s.
- LITTLE ARTHUR'S HISTORY OF ENGLAND. By LADY CALLCOTT. *New Edition, continued to 1872.* With Woodcuts. Fcap. 8vo. 1s. 6d.
- LIVINGSTONE (DR.). Popular Account of his First Expedition to Africa, 1840-56. Illustrations. Post 8vo. 7s. 6d.
- Popular Account of his Second Expedition to Africa, 1858-64. Map and Illustrations. Post 8vo. 7s. 6d.
- Last Journals in Central Africa, from 1865 to his Death. Continued by a Narrative of his last moments and sufferings. By Rev HORACE WALLER. Maps and Illustrations. 2 Vols. 8vo. 28s.
- LIVINGSTONIA. Journal of Adventures in Exploring the Lake Nyassa, and Establishing the above Settlement. By E. D. YOUNG, R.N. Revised by Rev. HORACE WALLER, F.R.G.S. Maps. Post 8vo.
- LIVONIAN TALES. By the Author of "Letters from the Baltic." Post 8vo. 2s.
- LOCH (H. B.). Personal Narrative of Events during Lord Elgin's Second Embassy to China. With Illustrations. Post 8vo. 9s.
- LOCKHART (J. G.). Ancient Spanish Ballads. Historical and Romantic. Translated, with Notes. With Portrait and Illustrations. Crown 8vo. 5s.
- Life of Theodore Hook. Fcap. 8vo. 1s.
- LOUDON (MRS.). Gardening for Ladies. With Directions and Calendar of Operations for Every Month. Woodcuts. Fcap. 8vo. 3s. 6d.
- LYELL (SIR CHARLES). Principles of Geology; or, the Modern Changes of the Earth and its Inhabitants considered as illustrative of Geology. With Illustrations. 2 Vols. 8vo. 32s.
- Student's Elements of Geology. With Table of British Fossils and 600 Illustrations. Post 8vo. 9s.
- Geological Evidences of the Antiquity of Man, including an Outline of Glacial Post-Tertiary Geology, and Remarks on the Origin of Species. Illustrations. 8vo. 14s.
- (K. M.). Geographical Handbook of Ferns. With Tables to show their Distribution. Post 8vo. 7s. 6d.
- LYTTON'S (LORD) Memoir of Julian Fane. With Portrait. Post 8vo. 5s.
- McCLINTOCK (SIR L.). Narrative of the Discovery of the Fate of Sir John Franklin and his Companions in the Arctic Seas. With Illustrations. Post 8vo. 7s. 6d.
- MACDOUGALL (COL.). Modern Warfare as Influenced by Modern Artillery. With Plans. Post 8vo. 12s.

- MACGREGOR (J.).** Rob Roy on the Jordan, Nile, Red Sea, Genesareth, &c. A Canoe Cruise in Palestine and Egypt and the Waters of Damascus. With Map and 70 Illustrations. Crown 8vo. 7s. 6d.
- MAETZNER'S ENGLISH GRAMMAR.** A Methodical, Analytical, and Historical Treatise on the Orthography, Prosody, Inflections, and Syntax of the English Tongue. Translated from the German. By CLAIR J. GRECK, LL.D. 8 Vols. 8vo. 36s.
- MAHON (LORD),** see STANHOPE.
- MAINE (SIR H. SUMNER).** Ancient Law: its Connection with the Early History of Society, and its Relation to Modern Ideas. 8vo. 12s.
- Village Communities in the East and West. With additional Essays. 8vo. 12s.
- Early History of Institutions. 8vo. 12s.
- MALCOLM (SIR JOHN).** Sketches of Persia. Post 8vo. 3s. 6d.
- MANSEL (DEAN).** Limits of Religious Thought Examined. Post 8vo. 8s. 6d.
- Letters, Lectures, and Papers, including the Phrontisterion, or Oxford in the XIXth Century. Edited by H. W. CHANDLER, M.A. 8vo. 12s.
- Gnostic Heresies of the First and Second Centuries. With a sketch of his life and character. By Lord CARNARVON. Edited by Canon LIGHTFOOT. 8vo. 10s. 6d.
- MANUAL OF SCIENTIFIC ENQUIRY.** For the Use of Travellers. Edited by REV. R. MAIN. Post 8vo. 3s. 6d. (*Published by order of the Lords of the Admiralty.*)
- MARCO POLO.** The Book of Ser Marco Polo, the Venetian. Concerning the Kingdoms and Marvels of the East. A new English Version. Illustrated by the light of Oriental Writers and Modern Travels. By COL. HENRY YULE. Maps and Illustrations. 2 Vols. Medium 8vo. 63s.
- MARKHAM'S (MRS.) History of England.** From the First Invasion by the Romans to 1867. Woodcuts. 12mo. 3s. 6d.
- History of France. From the Conquest by the Gauls to 1861. Woodcuts. 12mo. 3s. 6d.
- History of Germany. From the Invasion by Marins to 1867. Woodcuts. 12mo. 3s. 6d.
- MARLBOROUGH'S (SARAH, DUCHESS OF)** Letters. Now first published from the Original MSS. at Madresfield Court. With an Introduction. 8vo. 10s. 6d.
- MARRYAT (JOSEPH).** History of Modern and Mediæval Pottery and Porcelain. With a Description of the Manufacture. Plates and Woodcuts. 8vo. 42s. [Post 8vo. 7s. 6d.]
- MARSH (G. P.).** Student's Manual of the English Language.
- MASTERS in English Theology.** A Series of Lectures delivered at King's Coll., London, 1877. By Canon Barry, D.D., the Dean of St. Paul's; Prof. Plumpton, D.D.; Canon Westcott, D.D.; Canon Farrar, D.D.; and Prof. Cheetham, M.A. With an Historical Introduction. Post 8vo. [In Preparation.]
- MATTHIÆ'S GREEK GRAMMAR.** Abridged by BLONFIELD, Revised by E. S. CROOKE. 12mo. 4s.
- MAUREL'S** Character, Actions, and Writings of Wellington. Fcap. 8vo. 1s. 6d.
- MAYNE (CAPT.).** Four Years in British Columbia and Vancouver Island. Illustrations. 8vo. 16s.
- MAYO (LORD).** Sport in Abyssinia; or, the Mareb and Tack-azzee. With Illustrations. Crown 8vo. 12s.
- MEADE (HON. HERBERT).** Ride through the Disturbed Districts of New Zealand, with a Cruise among the South Sea Islands. With Illustrations. Medium 8vo. 12s.

- MELVILLE (HERMANN).** *Marquesas and South Sea Islands.* 2 Vols. Post 8vo. 7s.
- MEREDITH'S (MRS. CHARLES)** *Notes and Sketches of New South Wales.* Post 8vo. 2s.
- MESSIAH (THE):** *The Life, Travels, Death, Resurrection, and Ascension of our Blessed Lord.* By A. Layman. Map. 8vo. 18s.
- MICHELANGELO - BUONARROTI,** Sculptor, Painter, and Architect. *His Life and Works.* By C. HEATH WILSON. Illustrations. Royal 8vo. 26s.
- MILLINGTON (REV. T. S.)** *Signs and Wonders in the Land of Ham, or the Ten Plagues of Egypt, with Ancient and Modern Illustrations.* Woodcuts. Post 8vo. 7s. 6d.
- MILMAN (DEAN).** *History of the Jews, from the earliest Period down to Modern Times.* 3 Vols. Post 8vo. 18s.
- *Early Christianity, from the Birth of Christ to the Abolition of Paganism in the Roman Empire.* 3 Vols. Post 8vo. 18s.
- *Latin Christianity, including that of the Popes to the Pontificate of Nicholas V.* 9 Vols. Post 8vo. 54s.
- *Annals of St. Paul's Cathedral, from the Romans to the funeral of Wellington.* Portrait and Illustrations. 8vo. 18s.
- *Character and Conduct of the Apostles considered as an Evidence of Christianity.* 8vo. 10s. 6d.
- *Quinti Horatii Flacci Opera.* With 100 Woodcuts. Small 8vo. 7s. 6d.
- *Life of Quintus Horatius Flaccus.* With Illustrations. 8vo. 9s.
- *Poetical Works. The Fall of Jerusalem—Martyr of Antioch—Balshazzar—Tamor—Anne Boleyn—Fazio, &c.* With Portrait and Illustrations. 8 Vols. Fcap. 8vo. 18s.
- *Fall of Jerusalem.* Fcap. 8vo. 1s.
- (CAPT. E. A.) *Wayside Cross.* Post 8vo. 2s.
- MIVART'S (ST. GEORGE)** *Lessons from Nature; as manifested in Mind and Matter.* 8vo. 15s.
- MODERN DOMESTIC COOKERY.** *Founded on Principles of Economy and Practical Knowledge. New Edition.* Woodcuts. Fcap. 8vo. 5s.
- MONGREDIEN (AUGUSTUS).** *Trees and Shrubs for English Plantation.* A Selection and Description of the most Ornamental which will flourish in the open air in our climate. With Classified Lists. With 30 Illustrations. 8vo. 16s.
- MOORE'S (THOMAS)** *Life and Letters of Lord Byron.* Cabinet Edition. With Plates. 6 Vols. Fcap. 8vo. 18s.; Popular Edition, with Portraits. Royal 8vo. 7s. 6d.
- MORESBY (CAPT.), R.N.** *Discoveries in New Guinea, Polynesia, Torres Straits, &c., during the cruise of H.M.S. Basilisk.* Map and Illustrations. 8vo. 15s.
- MOTLEY (J. L.)** *History of the United Netherlands: from the Death of William the Silent to the Twelve Years' Truce, 1609.* Library Edition. Portraits. 4 Vols. 8vo. 60s. Cabinet Edition. 4 Vols. Post 8vo. 6s. each.
- *Life and Death of John of Barneveld, Advocate of Holland. With a View of the Primary Causes and Movements of the Thirty Years' War.* Library Edition. Illustrations. 3 Vols. 8vo. 28s. Cabinet Edition. 2 vols. Post 8vo. 12s.
- MOSSMAN (SAMUEL).** *New Japan; the Land of the Rising Sun; its Annals and Progress during the past Twenty Years, recording the remarkable Progress of the Japanese in Western Civilisation.* With Map. 8vo. 15s.

- MOUHOT (HENRI).** Siam, Cambodia, and Lao; a Narrative of Travels and Discoveries. Illustrations. 2 Vols. 8vo.
- MOZLEY'S (CANON)** Treatise on Predestination. 8vo. 14s.
- Primitive Doctrine of Baptismal Regeneration. 8vo. 7s. 6d.
- MUIRHEAD'S (JAS.)** Vaux-de-Vire of Maître Jean Le Houx, Advocate of Vire. Translated and Edited. With Portrait and Illustrations. 8vo. 21s.
- MUNRO'S (GENERAL)** Life and Letters. By REV. G. R. GLIWE. Post 8vo. 3s. 6d.
- MURCHISON'S (SIR RODERICK)** Siluria; or, a History of the Oldest rocks containing Organic Remains. Map and Plates. 8vo. 18s.
- Memoirs. With Notices of his Contemporaries, and Rise and Progress of Palaeozoic Geology. By ARCHIBALD GEIKIE. Portraits. 2 Vols. 8vo. 30s.
- MURRAY'S RAILWAY READING.** Containing:—
- | | |
|---------------------------------------|-----------------------------------|
| WELLINGTON. By LORD ELLENBOROUGH. 6d. | MARON'S JOAN OF ARC. 1s. |
| NIMROD OF THE CHASE. 1s. | HEAD'S EMIGRANT. 2s. 6d. |
| MUSIC AND DANCE. 1s. | NIMROD ON THE ROAD. 1s. |
| MILMAN'S FALL OF JERUSALEM. 1s. | COCKER ON THE GUILLOTTINE. 1s. |
| MARON'S "FOURTY-FIVE." 3s. | HOLLWAY'S NORWAY. 2s. |
| LIFE OF THEODORE BOOK. 1s. | MAUREL'S WELLINGTON. 1s. 6d. |
| DEEDS OF NAVAL DARING. 2s. 6d. | CAMPBELL'S LIFE OF BACON. 2s. 6d. |
| THE HONEY BEE. 1s. | THE FLOWER GARDEN. 1s. |
| ROOF'S FABLES. 2s. 6d. | TAYLOR'S NOTES FROM LIFE. 2s. |
| NIMROD ON THE TARP. 1s. 6d. | ELLECTED ADDRESSES. 1s. |
| ART OF DINING. 1s. 6d. | FARR'S HINTS ON ANGLING. 1s. |
- MUSTERS' (CAPT.)** Patagonians; a Year's Wanderings over Untrodden Ground from the Straits of Magellan to the Rio Negro. Illustrations. Post 8vo. 7s. 6d.
- NAPIER (SIR WM.)** English Battles and Sieges of the Peninsular War. Portrait. Post 8vo. 9s.
- NAPOLEON AT FONTAINEBLEAU AND ELBA.** A Journal of Occurrences and Notes of Conversations. By SIR NEIL CAMPBELL, C.B. With a Memoir. By REV. A. N. C. MAULACHLAN, M.A. Portrait. 8vo. 15s.
- NARES (SIR GEORGE), R.N.** Official Report to the Admiralty of the recent Arctic Expedition. Map. 8vo. 2s. 6d.
- NASMYTH AND CARPENTER.** The Moon. Considered as a Planet, a World, and a Satellite. With Illustrations from Drawings made with the aid of Powerful Telescopes, Woodcuts, &c. 4to. 30s.
- NAUTICAL ALMANAC (THE).** (By Authority.) 2s. 6d.
- NAVY LIST.** (Monthly and Quarterly.) Post 8vo.
- NEW TESTAMENT.** With Short Explanatory Commentary. By ARCHDEACON CHURTON, M.A., and ARCHDEACON BASIL JONES, M.A. With 110 authentic Views, &c. 2 Vols. Crown 8vo 21s. bound.
- NEWTN (SAMUEL).** First Book of Natural Philosophy; an Introduction to the Study of Statics, Dynamics, Hydrostatics, Optics, and Acoustics, with numerous Examples. Small 8vo. 3s. 6d.
- Elements of Mechanics, including Hydrostatics, with numerous Examples. Small 8vo. 3s. 6d.
- Mathematical Examinations. A Graduated Series of Elementary Examples in Arithmetic, Algebra, Logarithms, Trigonometry, and Mechanics. Small 8vo. 3s. 6d.
- NICHOLS' (J. G.)** Pilgrimages to Walsingham and Canterbury. By ERASMUS. Translated, with Notes. With Illustrations. Post 8vo. 6s.
- (SIR GEORGE) History of the English Poor Laws. 2 Vols. 8vo.
- NICOLAS' (SIR HARRIS)** Historic Peerage of England. Exhibiting the Origin, Descent, and Present State of every Title of Peerage which has existed in this Country since the Conquest. By WILLIAM COURTHOPE. 8vo. 30s.

- NIMROD.** On the Chase—Turf—and Road. With Portrait and Plates. Crown 8vo. 3s. Or with Coloured Plates, 7s. 6d.
- NORDHOFF (CHAS.).** Communistic Societies of the United States, including Detailed Accounts of the Shakers, The Amasa, Oneida, Bethell, Aurora, Icarian and other existing Societies: with Particulars of their Religious Creeds, Industries, and Present Condition. With 40 Illustrations. 8vo. 15s.
- NORTHCOTE'S SIR JOHN.** Notebook in the Long Parliament. Containing Proceedings during its First Session, 1640. From the Original M.S. in the possession of the Right Hon. Sir Stafford Northcote, Bart., M.P. Transcribed and Edited, with a Memoir. By A. H. A. Hamilton. Crown 8vo. [In the Press.]
- OWEN (LEUT.-COL.).** Principles and Practice of Modern Artillery, including Artillery Material, Gunnery, and Organisation and Use of Artillery in Warfare. With Illustrations. 8vo. 15s.
- OXENHAM (REV. W.).** English Notes for Latin Elegiacs; designed for early Students in the Art of Latin Versification, with Profane Rules of Composition in Elegiac Metre. 12mo. 3s. 6d.
- PALGRAVE (R. H. L.).** Local Taxation of Great Britain and Ireland. 8vo. 5s.
- **NOTES ON BANKING IN GREAT BRITAIN AND IRELAND, SWEDEN, DENMARK, AND HAMBURG,** with some Remarks on the amount of Bills in circulation, both Inland and Foreign. 8vo. 6s.
- PALLISER MRS.** Brittany and its Byeways, its Inhabitants, and Antiquities. With Illustrations. Post 8vo. 12s.
- **MOTTOES FOR MONUMENTS, or Epitaphs selected for General Use and Study.** With Illustrations. Crown 8vo. 7s. 6d.
- PARIS (DR.)** Philosophy in Sport made Science in Earnest; or, the First Principles of Natural Philosophy inculcated by aid of the Toys and Sports of Youth. Woodcut. Post 8vo. 7s. 6d.
- PARKMAN (FRANCIS).** Discovery of the Great West; or, The Valleys of the Mississippi and the Lakes of North America. An Historical Narrative. Map. 8vo. 10s. 6d.
- PARKYNS' (MASSFIELD) Three Years' Residence in Abyssinia:** with Travels in that Country. With Illustrations. Post 8vo. 7s. 6d.
- PEEK PRIZE ESSAYS.** The Maintenance of the Church of England as an Established Church. By REV. CHARLES HOBE—REV. K. WATSON DIXON—and REV. JULIUS LLOYD. 8vo. 10s. 6d.
- PEEL'S (SIR ROBERT) Memoirs.** 2 Vols. Post 8vo. 15s.
- PENN (RICHARD).** Maxims and Hints for an Angler and Chess-player. Woodcut. Fcap. 8vo. 1s.
- PERCY (JOHN, M.D.). Metallurgy.** Vol. I., Part 1. FUEL, Wood, Peat, Coal, Charcoal, Coke, Refractory Materials, Fire-Clays, &c. With Illustrations. 8vo. 30s.
- Vol. I., Part 2. Copper, Zinc, Brass. With Illustrations. 8vo. [In the Press.]
- Vol. II. Iron and Steel. With Illustrations. 8vo. [In Preparation.]
- Vol. III. Lead, including part of SILVER. With Illustrations. 8vo. 30s.
- Vol. IV. and V. Gold, Silver, and Mercury, Platinum, Tin, Nickel, Cobalt, Antimony, Bismuth, Arsenic, and other Metals. With Illustrations. 8vo. [In Preparation.]
- PHILLIPS' (JOHN) Memoirs of William Smith.** 8vo. 7s. 6d.
- (JOHN) Geology of Yorkshire, The Coast, and Limestone District. Plates. 2 Vols. 4to.
- Rivers, Mountains, and Sea Coast of Yorkshire. With Essays on the Climate, Scenery, and Ancient Inhabitants. Plates. 8vo. 15s.

- PHILLIPS' (SAMUEL)** Literary Essays from "The Times." With Portrait. 2 Vols. Fcap. 8vo. 7s.
- POPE'S (ALEXANDER)** Works. With Introductions and Notes, by REV. WHITWELL ELWIN. Vols. I., II., VI., VII., VIII. With Portraits. 8vo. 10s. 6d. each.
- PORTER (REV. J. L.)** Damascus, Palmyra, and Lebanon. With Travels among the Giant Cities of Bashan and the Hauran. Map and Woodcuts. Post 8vo. 7s. 6d.
- PRAYER-BOOK (ILLUSTRATED)**, with Borders, Initials, Vignettes, &c. Edited, with Notes, by REV. THOS. JAMES. Medium 8vo. 18s. cloth; 31s. 6d. calf; 36s. morocco.
- PRINCESS CHARLOTTE OF WALES.** A Brief Memoir. With Selections from her Correspondence and other unpublished Papers. By LADY ROSE WIGALL. With Portrait. 8vo. 8s. 6d.
- PUSS IN BOOTS.** With 12 Illustrations. By OTTO SPEKTER. 16mo. 1s. 6d. Or coloured, 2s. 6d.
- PRIVY COUNCIL JUDGMENTS** in Ecclesiastical Cases relating to Doctrine and Discipline. With Historical Introduction, by G. C. BRODRICK and W. H. FREMANTLE. 8vo. 10s. 6d.
- QUARTERLY REVIEW (THE).** 8vo. 6s.
- RAE (EDWARD).** Land of the North Wind; or Travels among the Lapländers and Samoyedes, and along the Shores of the White Sea. With Map and Woodcuts. Post 8vo. 10s. 6d.
- The Country of the Moors. A Journey from Tripoli in Barbary to the City of Kairwan. Crown 8vo. [In the Press.]
- RAMBLES** in the Syrian Deserts. Post 8vo. 10s. 6d.
- RANKE (LEOPOLD).** History of the Popes of Rome during the 16th and 17th Centuries. Translated from the German by SARAH AUSTIN. 3 Vols. 8vo. 30s.
- RASSAM (HORMUZD).** Narrative of the British Mission to Abyssinia. With Notices of the Countries Traversed from Massowah to Magdala. Illustrations. 2 Vols. 8vo. 28s.
- RAWLINSON'S (CANON)** Herodotus. A New English Version. Edited with Notes and Essays. Maps and Woodcut. 4 Vols. 8vo. 48s.
- Five Great Monarchies of Chaldæa, Assyria, Media, Babylonia, and Persia. With Maps and Illustrations. 3 Vols. 8vo. 42s.
- (SIR HENRY) England and Russia in the East; a Series of Papers on the Political and Geographical Condition of Central Asia. Map. 8vo. 12s.
- REED (E. J.)** Shipbuilding in Iron and Steel; a Practical Treatise, giving full details of Construction, Processes of Manufacture, and Building Arrangements. With 5 Plans and 250 Woodcuts. 8vo.
- Iron-Clad Ships; their Qualities, Performances, and Cost. With Chapters on Turret Ships, Iron-Clad Rams, &c. With Illustrations. 8vo. 12s.
- Letters from Russia in 1875. 8vo. 5s.
- REJECTED ADDRESSES (THE).** By JAMES AND HORACE SMITH. Woodcuts. Post 8vo. 3s. 6d.; or *Popular Edition*, Fcap. 8vo. 1s.
- REYNOLDS' (SIR JOSHUA)** Life and Times. By C. R. LESLIE, R.A. and TOM TAYLOR. Portraits. 2 Vols. 8vo.
- RICARDO'S (DAVID)** Political Works. With a Notice of his Life and Writings. By J. R. McCulloch. 8vo. 16s.
- RIPA (FATHER).** Thirteen Years' Residence at the Court of Peking. Post 8vo. 2s.
- ROBERTSON (CANON).** History of the Christian Church, from the Apostolic Age to the Reformation, 1517. *Library Edition*. 4 Vols. 8vo. *Cabinet Edition*. 8 Vols. Post 8vo. 6s. each.

- ROBINSON (REV. DR.).** *Biblical Researches in Palestine and the Adjacent Regions, 1838—53.* Maps. 3 Vols. 8vo. 42s.
- *Physical Geography of the Holy Land.* Post 8vo. 10s. 6d.
- (WM.) *Alpine Flowers for English Gardens.* With 70 Illustrations. Crown 8vo. 12s.
- *Wild Gardens; or, our Groves and Shrubberies made beautiful by the Naturalization of Hardy Exotic Plants.* With Frontispiece. Small 8vo. 6s.
- *Sub-Tropical Gardens; or, Beauty of Form in the Flower Garden.* With Illustrations. Small 8vo. 7s. 6d.
- ROBSON (E. R.).** *SCHOOL ARCHITECTURE.* Being Practical Remarks on the Planning, Designing, Building, and Furnishing of School-houses. With 300 Illustrations. Medium 8vo. 18s.
- ROME (HISTORY OF).** See LIDDELL and SMITH.
- ROWLAND (DAVID).** *Manual of the English Constitution.* Its Rise, Growth, and Present State. Post 8vo. 10s. 6d.
- *Laws of Nature the Foundation of Morals.* Post 8vo. 6s.
- RUNDELL'S (MRS.)** *Modern Domestic Cookery.* Fcap. 8vo. 5s.
- RUXTON (GEORGE F.).** *Travels in Mexico; with Adventures among the Wild Tribes and Animals of the Prairies and Rocky Mountains.* Post 8vo. 8s. 6d.
- SALE'S (SIR ROBERT)** *Brigade in Afghanistan.* With an Account of the Defence of Jellalabad. By REV. G. R. GLAUCO. Post 8vo. 2s.
- SCEPTICISM IN GEOLOGY; and the Reasons for It.** By VERIFIER. Crown 8vo. 6s.
- SCHLIEMANN (DR. HENRY).** *Troy and Its Remains.* A Narrative of Researches and Discoveries made on the Site of Ilium, and in the Trojan Plain. With Maps, Views, and 500 Illustrations. Medium 8vo. 42s.
- *Discoveries on the Site of Ancient Mycenæ.* With numerous Illustrations, Plans, &c. Medium 8vo. [*In Preparation.*]
- SCOTT (SIR G. G.).** *Secular and Domestic Architecture, Present and Future.* 8vo. 9s.
- (DEAN) *University Sermons.* Post 8vo. 8s. 6d.
- SCROPE (G. P.).** *Geology and Extinct Volcanoes of Central France.* Illustrations. Medium 8vo. 30s.
- SHADOWS OF A SICK ROOM.** With a Preface by Canon LINDOR. 16mo. 2s. 6d.
- SHAH OF PERSIA'S** *Diary during his Tour through Europe in 1873.* Translated from the Original. By J. W. REBOUSS. With Portrait and Coloured Title. Crown 8vo. 12s.
- SMILES' (SAMUEL)** *British Engineers; from the Earliest Period to the death of the Stephensons.* With Illustrations. 5 Vols. Crown 8vo. 7s. 6d. each.
- *George and Robert Stephenson.* Illustrations. Medium 8vo. 21s.
- *Boulton and Watt.* Illustrations. Medium 8vo. 21s.
- *Life of a Scotch Naturalist (Thomas Edward).* With Portrait and Illustrations. Crown 8vo. 10s. 6d.
- *Huguenots in England and Ireland.* Crown 8vo. 7s. 6d.
- *Self-Help.* With Illustrations of Conduct and Perseverance. Post 8vo. 6s. Or in French, 5s.
- *Character.* A Sequel to "SELF-HELP." Post 8vo. 6s.
- *THRIFT.* A Book of Domestic Counsel. Post 8vo. 6s.
- *Industrial Biography; or, Iron Workers and Tool Makers.* Post 8vo. 6s.

- SMILES' (SAMUEL) Boy's Voyage round the World. With Illustrations. Post 8vo. 6s.
- SMITH'S (DR. WM.) Dictionary of the Bible; its Antiquities, Biography, Geography, and Natural History. Illustrations. 3 Vols. 8vo. 106s.
- Concise Bible Dictionary. With 300 Illustrations. Medium 8vo. 21s.
- Smaller Bible Dictionary. With Illustrations. Post 8vo. 7s. 6d.
- Christian Antiquities. Comprising the History, Institutions, and Antiquities of the Christian Church. With Illustrations. Vol. I. 8vo. 81s. 6d.
- Biography, Literature, Sects, and Doctrines; from the Times of the Apostles to the Age of Charlemagne. Vol. I. 8vo. 81s. 6d.
- Atlas of Ancient Geography—Biblical and Classical. Folio. 6l. 6s.
- Greek and Roman Antiquities. With 500 Illustrations. Medium 8vo. 28s.
- Biography and Mythology. With 600 Illustrations. 3 Vols. Medium 8vo. 4l. 4s.
- Geography. 2 Vols. With 500 Illustrations. Medium 8vo. 56s.
- Classical Dictionary of Mythology, Biography, and Geography. 1 Vol. With 750 Woodcuts. 8vo. 18s.
- Smaller Classical Dictionary. With 200 Woodcuts. Crown 8vo. 7s. 6d.
- Smaller Greek and Roman Antiquities. With 200 Woodcuts. Crown 8vo. 7s. 6d.
- Complete Latin-English Dictionary. With Tables of the Roman Calendar, Measures, Weights, and Money. 8vo. 21s.
- Smaller Latin-English Dictionary. 12mo. 7s. 6d.
- Copious and Critical English-Latin Dictionary. 8vo. 21s.
- Smaller English-Latin Dictionary. 12mo. 7s. 6d.
- School Manual of English Grammar, with Copious Exercises. Post 8vo. 8s. 6d.
- Modern Geography, Physical and Political. Post 8vo. 6s.
- Primary English Grammar. 16mo. 1s.
- History of Britain. 12mo. 2s. 6d.
- French Principia. Part I. A First Course, containing a Grammar, Delectus, Exercises, and Vocabularies. 12mo. 3s. 6d.
- Part II. A Reading Book, containing Fables, Stories, and Anecdotes, Natural History, and Scenes from the History of France. With Grammatical Questions, Notes and copious Etymological Dictionary. 12mo. 4s. 6d.
- Part III. Prose Composition, containing a Systematic Course of Exercises on the Syntax, with the Principal Rules of Syntax. 12mo. [In the Press.]
- Student's French Grammar. By C. HERON-WALL. With Introduction by M. Littré. Post 8vo. 7s. 6d.
- Smaller Grammar of the French Language. Abridged from the above. 12mo. 3s. 6d.
- German Principia, Part I. A First German Course, containing a Grammar, Delectus, Exercise Book, and Vocabularies. 12mo. 3s. 6d.

- SMITH'S (DR. WM.) German Principia, Part II. A Reading Book;** containing Fables, Stories, and Anecdotes, Natural History, and Scenes from the History of Germany. With Grammatical Questions, Notes, and Dictionary. 12mo. 3s. 6d.
- **Part III. An Introduction to German Prose Composition;** containing a Systematic Course of Exercises on the Syntax, with the Principal Rules of Syntax. 12mo. *[In the Press.]*
- **Practical German Grammar.** Post 8vo. 3s. 6d.
- **Principia Latina—Part I. First Latin Course,** containing a Grammar, Delectus, and Exercise Book, with Vocabularies. 12mo. 3s. 6d.
- *.* In this Edition the Cases of the Nouns, Adjectives, and Pronouns are arranged both as in the ORDINARY GRAMMARS and as in the PUBLIC SCHOOL PRIMER, together with the corresponding Exercises.
- **Part II. A Reading-book of Mythology, Geography, Roman Antiquities, and History.** With Notes and Dictionary. 12mo. 3s. 6d.
- **Part III. A Poetry Book.** Hexameters and Pentameters; Eclog. Ovidians; Latin Prosody. 12mo. 3s. 6d.
- **Part IV. Prose Composition. Rules of Syntax with Examples, Explanations of Synonyms, and Exercises on the Syntax.** 12mo. 3s. 6d.
- **Principia Latina—Part V. Short Tales and Anecdotes for Translation into Latin.** 12mo. 3s.
- **Latin-English Vocabulary and First Latin-English Dictionary for Phædrus, Cornelius Nepos, and Caesar.** 12mo. 3s. 6d.
- **Student's Latin Grammar.** Post 8vo. 6s.
- **Smaller Latin Grammar.** 12mo. 3s. 6d.
- **Tacitus, Germania, Agricola, &c.** With English Notes. 12mo. 3s. 6d.
- **Initia Græca, Part I. A First Greek Course,** containing a Grammar, Delectus, and Exercise-book. With Vocabularies. 12mo. 3s. 6d.
- **Part II. A Reading Book. Containing Short Tales, Anecdotes, Fables, Mythology, and Grecian History.** 12mo. 3s. 6d.
- **Part III. Prose Composition. Containing the Rules of Syntax, with copious Examples and Exercises.** 12mo. 3s. 6d.
- **Student's Greek Grammar.** By CURTIUS. Post 8vo. 6s.
- **Smaller Greek Grammar.** 12mo. 3s. 6d.
- **Greek Accidence.** 12mo. 2s. 6d.
- **Plato, Apology of Socrates, &c., with Notes.** 12mo. 3s. 6d.
- **Smaller Scripture History.** Woodcuts. 16mo. 3s. 6d.
- **Ancient History.** Woodcuts. 16mo. 3s. 6d.
- **Geography.** Woodcuts. 16mo. 3s. 6d.
- **Rome.** Woodcuts. 16mo. 3s. 6d.
- **Greece.** Woodcuts. 16mo. 3s. 6d.
- **Classical Mythology.** Woodcuts. 16mo. 3s. 6d.
- **History of England.** Woodcuts. 16mo. 3s. 6d.
- **English Literature.** 16mo. 3s. 6d.
- **Specimens of English Literature.** 16mo. 3s. 6d.

- SHAW (T. B.). Student's Manual of English Literature. Post 8vo. 7s. 6d.
- Specimens of English Literature. Selected from the Chief Writers. Post 8vo. 7s. 6d.
- (ROBERT). Visit to High Tartary, Yarkand, and Kashgar (formerly Chinese Tartary), and Return Journey over the Karakorum Pass. With Map and Illustrations. 8vo. 16s.
- SHIRLEY (EVELYN P.). Deer and Deer Parks; or some Account of English Parks, with Notes on the Management of Deer. Illustrations. 4to. 21s.
- SIERRA LEONE; Described in Letters to Friends at Home. By A LADY. Post 8vo. 3s. 6d.
- SMITH (PHILIP). History of the Ancient World, from the Creation to the Fall of the Roman Empire, A. D. 476. *Fourth Edition*. 3 Vols. 8vo. 31s. 6d.
- SIMMONS' (CAPT.) Constitution and Practice of Courts-Martial. *Seventh Edition*. 8vo. 15s.
- SPALDING (CAPTAIN). Tale of Frithiof. Translated from the Swedish of ESTAS TRONER. Post 8vo. 7s. 6d.
- STANLEY (DEAN). Sinai and Palestine, in connexion with their History. Map. 8vo. 14s.
- Bible in the Holy Land; Extracted from the above Work. Woodcuts. Fcap. 8vo. 2s. 6d.
- Eastern Church. Plans. 8vo. 12s.
- Jewish Church. *1st & 2nd Series*. From the Earliest Times to the Captivity. 2 Vols. 8vo. 24s.
- *Third Series*. From the Captivity to the Destruction of Jerusalem. 8vo. 14s.
- Epistles of St. Paul to the Corinthians. 8vo. 18s.
- Life of Dr. Arnold, of Rugby. With selections from his Correspondence. With portrait. 2 vols. Crown 8vo. 12s.
- Church of Scotland. 8vo. 7s. 6d.
- Memorials of Canterbury Cathedral. Woodcuts. Post 8vo. 7s. 6d.
- Westminster Abbey. With Illustrations. 8vo. 15s.
- Sermons during a Tour in the East. 8vo. 9s.
- ADDRESSES AND CHARGES OF THE LATE BISHOP STANLEY. With Memoir. 8vo. 10s. 6d.
- STEPHEN (REV. W. R.). Life and Times of St. Chrysostom. With Portrait. 8vo. 15s.
- ST. JAMES LECTURES. Companions for the Devout Life. 2 Vols. 8vo. 7s. 6d. each.
- *First Series*, 1875.
- *Second Series*, 1876.
- IMITATION OF CHRIST. CANON FABRÆ.
- PENANCES OF ELAISE PASCAL. DEAN ASHWELL.
- CHURCH.
- FENELON'S ŒUVRES SPIRITUELLES. REV. T. T. CARTER.
- S. FRANÇOIS DE SALES. DEAN GOULBURN.
- ANDREWES' DEVOTIONS. BISHOP OF ELY.
- BAITRE'S SAINTS' REST. ARCHBISHOP TRENCH.
- CHRISTIAN YEAR. CANON BARRY.
- S. AUGUSTINE'S CONFESSIONS. BISHOP ALEXANDER.
- PARADISE LOST. REV. E. H. BICKERSTETH.
- JEREMY TAYLOR'S HOLY LIVING AND DYING. REV. DR. HUMPHREY.
- PILGRIM'S PROGRESS. DEAN HOWSON.
- ST. JOHN (CHARLES). Wild Sports and Natural History of the Highlands. Post 8vo. 8s. 6d.
- (BAYLE) Adventures in the Libyan Desert. Post 8vo. 2s.

- OLD TESTAMENT HISTORY**; from the Creation to the Return of the Jews from Captivity. Maps and Woodcuts. Post Svo. 7s. 6d.
- NEW TESTAMENT HISTORY**. With an Introduction respecting the History of the Old and New Testaments. Maps and Woodcuts. Post Svo. 7s. 6d.
- ECCLESIASTICAL HISTORY**. A History of the Christian Church from its Foundation to the Eve of the Protestant Reformation. Post Svo. 7s. 6d.
- MANUAL OF ENGLISH CHURCH HISTORY**, from the Reformation to the Present Time. By Rev. G. G. PERRY, Vicar of St. Andrew's Church and Rector of Waddington. Post Svo.
- ANCIENT HISTORY OF THE EAST**; Egypt, Assyria, Babylonia, Media, Persia, Asia Minor, and Phœnicia. Woodcuts. Post Svo. 7s. 6d.
- GEOGRAPHY**. By Rev. W. L. BEVAN. Woodcuts. Post Svo. 7s. 6d.
- HISTORY OF GREECE**; from the Earliest Times to the Roman Conquest. By Wm. SMITH, D.C.L. Woodcuts. Post Svo. 7s. 6d.
- HISTORY OF ROME**; from the Earliest Times to the Establishment of the Empire. By DEAN LIDDELL. Woodcuts. Post Svo. 7s. 6d.
- GISSANI'S Decline and Fall of the Roman Empire**. Woodcuts. Post Svo. 7s. 6d.
- HALLAM'S HISTORY OF EUROPE** during the Middle Ages. Post Svo. 7s. 6d.
- HALLAM'S HISTORY OF ENGLAND**; from the Accession of Henry VII. to the Death of George II. Post Svo. 7s. 6d.
- HUMES' History of England** from the Invasion of Julius Cæsar to the Revolution in 1688. Continued down to 1698. Woodcuts. Post Svo. 7s. 6d.
- HISTORY OF FRANCE**; from the Earliest Times to the Establishment of the Second Empire, 1834. By Rev. H. W. JAMES. Woodcuts. Post Svo. 7s. 6d.
- ENGLISH LANGUAGE**. By Geo. P. MARSH. Post Svo. 7s. 6d.
- LITERATURE**. By T. B. SHAW, M.A. Post Svo. 7s. 6d.
- SPECIMENS of English Literature** from the Chief Writers. By T. B. SHAW. Post Svo. 7s. 6d.
- MODERN GEOGRAPHY**; Mathematical, Physical, and Descriptive. By Rev. W. L. BEVAN. Woodcuts. Post Svo. 7s. 6d.
- MORAL PHILOSOPHY**. By WILLIAM FLEMING, M.A. Post Svo. 7s. 6d.
- BLACKSTONE'S Commentaries on the Laws of England**. By R. MALCOLM KERR, LL.D. Post Svo. 7s. 6d.
- SUMNER'S (Bishop) Life and Episcopate during 40 Years**. By Rev. G. H. SUMNER. Portrait. 8vo. 14s.
- STREET (G. E.) Gothic Architecture in Spain**. From Personal Observations made during several Journeys. With Illustrations. Royal 8vo. 30s.
- Italy, chiefly in Brick and Marble. With Notes of Tours in the North of Italy. With 60 Illustrations. Royal 8vo. 26s.

- STANHOPE (EARL)** England from the Reign of Queen Anne to the Peace of Versailles, 1701-83. *Library Edition*. 8 vols. 8vo. *Cabinet Edition*, 9 vols. Post 8vo. 5s. each.
- British India, from its Origin to 1783. 8vo. 3s. 6d.
- History of "Forty-Five." Post 8vo. 3s.
- Historical and Critical Essays. Post 8vo. 3s. 6d.
- French Retreat from Moscow, and other Essays. Post 8vo. 7s. 6d.
- Life of Belisarius. Post 8vo. 10s. 6d.
- Condé. Post 8vo. 3s. 6d.
- William Pitt. Portraits. 4 Vols. 8vo. 24s.
- Miscellanies. 2 Vols. Post 8vo. 13s.
- Story of Joan of Arc. Fcap. 8vo. 1s.
- Addresses on Various Occasions. 16mo. 1s.
- STYFFE (KNUT)**. Strength of Iron and Steel. Plates. 8vo. 12s.
- SOMERVILLE (MARY)**. Personal Recollections from Early Life to Old Age. With her Correspondence. Portrait. Crown 8vo. 12s.
- Physical Geography. Portrait. Post 8vo. 9s.
- Connexion of the Physical Sciences. Portrait. Post 8vo. 9s.
- Molecular and Microscopic Science. Illustrations. 2 Vols. Post 8vo. 21s.
- SOUTHEY (ROBERT)**. Lives of Bunyan and Cromwell. Post 8vo. 2s.
- SWAINSON (CAROL)**. Nicene and Apostles' Creeds; Their Literary History; together with some Account of "The Creed of St. Athanasius." 8vo. 16s.
- SYBEL (VON)** History of Europe during the French Revolution, 1789-1795. 4 Vols. 8vo. 48s.
- SYMONDS' (REV. W.)** Records of the Rocks; or Notes on the Geology, Natural History, and Antiquities of North and South Wales, Siluria, Devon, and Cornwall. With Illustrations. Crown 8vo. 12s.
- THIBAUT (ANTOINE)** On Purity in Musical Art. Translated from the German. With a prefatory Memoir by W. H. Gladstone, M.P. Post 8vo. [*In preparation.*]
- THIELMANN (BARON)** Journey through the Caucasus to Tabreez, Kurdistan, down the Tigris and Euphrates to Nineveh and Babylon, and across the Desert to Palmyra. Translated by CHAS. HENNAOK. Illustrations. 2 Vols. Post 8vo. 18s.
- THOMAS' (W. J.)** Longevity of Man; its Facts and its Fiction. Including Observations on the more Remarkable Instances. Post 8vo. 10s. 6d.
- THOMSON (ARCHBISHOP)**. Lincoln's Inn Sermons. 8vo. 10s. 6d.
- Life in the Light of God's Word. Post 8vo. 5s.
- TITIAN**. His Life and Times. With some account of his Family, chiefly from new and unpublished Records. By J. A. CROWN and G. B. CAVALCASSELLE. With Portrait and Illustrations. 2 Vols. 8vo. 42s.
- TOCQUEVILLE'S** State of Society in France before the Revolution, 1789, and on the Causes which led to that Event. Translated by HENRY REVE. 8vo. 14s.
- TOMLINSON (CHARLES)**; The Sonnet; Its Origin, Structure, and Place in Poetry. With translations from Dante, Petrarch, &c. Post 8vo. 9s.

- TOZER** BRN. H. F. Highlands of Turkey, with Visits to Mounts Taurus, Ararat, and the Taurus. 2 Vols. Crown 8vo. 12s.
- Lectures on the Geography of Greece. Map. Post 8vo. 6s.
- TRISTRAM** (Capt.) Great Sahara. Illustrations. Crown 8vo. 15s.
- Land of Moab; Travels and Discoveries on the East Side of the Dead Sea and the Jordan. Illustrations. Crown 8vo. 12s.
- TWISLETON** KEWAN. The Tongue not Essential to Speech, with Illustrations of the Effect of Speech in the case of the African Languages. Post 8vo. 5s.
- TWISS** HENRY. Life of Lord Eldon. 2 Vols. Post 8vo. 21s.
- TYLOR** E. B. Early History of Mankind, and Development of Civilization. 2 Vols. 12s.
- Primitive Culture: the Development of Mythology, Philosophy, Religion, Art, and Custom. 2 Vols. 8vo. 16s.
- VAMBERY** ARMINIUS. Travels from Teheran across the Turko-mania Desert to the Eastern Shore of the Caspian. Illustrations. 8vo. 21s.
- VAN LENNEP** HENRY J. Travels in Asia Minor. With Illustrations of Biblical Literature and Archaeology. With Woodcuts. 2 Vols. Post 8vo. 14s.
- Modern Customs and Manners of Bible Lands, in Illustration of Scripture. With Maps and 100 Illustrations. 2 Vols. 8vo. 17s.
- WELLINGTON'S** Despatches during his Campaigns in India, Denmark, Portugal, Spain, the Low Countries, and France. Edited by Colonel GURWOOD. 2 Vols. 8vo. 20s. each.
- Supplementary Despatches, relating to India, Ireland, Denmark, Spanish America, Spain, Portugal, France, Congress of Vienna, Waterloo and Paris. Edited by his Son. 14 Vols. 8vo. 20s. each. * In India. 8vo. 2s.
- Civil and Political Correspondence. Edited by his Son. Vols. I. to V. 8vo. 20s. each.
- Vol. VI., relating to the Eastern Question of 1829. Russian Intergal, Turkish Affairs, Treaty of Adrianople, &c. 8vo.
- Speeches in Parliament. 2 Vols. 8vo. 42s.
- WHEELER** (G.). Choice of a Dwelling: a Practical Handbook of Useful Information in Building a House. Plans. Post 8vo. 7s. 6d.
- WHITE** (W. H.). Manual of Naval Architecture, for the use of Officers. Illustrations. 8vo. [In the Press.]
- WILBERFORCE'S** (BISHOP) Life of William Wilberforce. Portrait. Crown 8vo. 6s.
- WILKINSON** (SIR J. G.). Manners and Customs of the Ancient Egyptians, their Private Life, Government, Laws, Arts, Manufactures, Religion, &c. A new edition, with additions by the late Author. Edited by SAMUEL BIRCH, LL.D. Illustrations. 3 Vols. 8vo.
- Popular Account of the Ancient Egyptians. With 500 Woodcuts. 2 Vols. Post 8vo. 12s.
- WOODS** (CAPTAIN) Source of the Oxus. With the Geography of the Valley of the Oxus. By COL. YULE. Map. 8vo. 12s.
- WORDS OF HUMAN WISDOM.** Collected and Arranged by E. S. With a Preface by CAROL LINDNER. Fcap. 8vo. 3s. 6d.
- WORDSWORTH'S** (BISHOP) Athens and Attica. Plates. 8vo. 5s.
- YULE'S** (COLONEL) Book of Marco Polo. Illustrated by the Light of Original Writers and Modern Travels. With Maps and 80 Plates. 2 Vols. Medium 8vo. 63s.



